

RX-7

Factory Service Material

This manual can be downloaded for free from
<http://members.xoom.com/twinturboteddy/fsm/rx7.htm>

Or you can donate \$10 to diepat@earthlink.net through **paypal.com** and a gift CD with all manuals and resources I carry will be sent to you.

This includes

- 1993 Factory Service Manual
- 1988 Factory Service Manual
- 1995 Printed Microfiche of all parts
- 1989 Printed Microfiche of all parts*
- 1990 Printed Microfiche of all parts*
- 1986 Printed Microfiche of all parts*
- 1987 Printed Microfiche of all parts*
- 1988 Printed Microfiche of all parts*

The \$10 donation is used to offset the tremendous amount of time it takes to make everything available.



* These works are currently in process and may or not be readily available upon request. They will be hosted on the same link above and for download

**1988
Mazda
RX-7**

Wiring Diagram

FOREWORD

This wiring diagram incorporates the wiring schematic for the basic vehicle and its available optional equipment. Actual vehicle wiring may vary slightly depending upon optional equipment and/or local specifications. All information contained in this booklet is based on the latest information available at the time of printing. Mazda Motor Corporation reserves the right to make changes without previous notice.

**Mazda Motor Corporation
HIROSHIMA, JAPAN**

Name	Page
■ HOW TO USE THIS WIRING DIAGRAM	50-3
■ SYMBOLS IN THIS WIRING DIAGRAM	50-7
■ HOW TO READ ELECTRIC PARTS	50-8
■ PARTS INDEX (ABBREVIATIONS)	50-10
■ POWER SYSTEM	50-12
■ ELECTRICAL WIRING SCHEMATIC	50-14
■ STARTING & CHARGING SYSTEM	50-16
■ E.G.I. & EMISSION CONTROL & IGNITION SYSTEM	50-22
■ FUEL PUMP & SUB-ZERO STARTING ASSIST SYSTEM	50-34
■ COOLING FAN SYSTEM	50-38
■ METERS & WARNING SYSTEM	50-40
■ FRONT WIPER & WASHER	50-44
■ REAR WIPER & WASHER	50-46
■ HEADLIGHTS	50-48
■ RETRACTABLE HEADLIGHTS	
■ HEADLIGHT CLEANER	50-50
■ ILLUMINATION LIGHTS	
■ COMBINATION LIGHTS	
■ LICENSE LIGHTS	
■ STORAGE BOX LIGHTS	50-54
■ GLOVE BOX LIGHT	
■ STOP LIGHTS ■ HORN	50-58
■ TURN & HAZARD FLASHER LIGHTS	50-60
■ BACK-UP LIGHTS	
■ HEATER & AIR CONDITIONER	50-64
■ WARNING & AUTO CLOCK SYSTEM	50-70
■ CARGO ROOM LIGHT	
■ COURTESY LIGHTS	
■ INTERIOR & SPOT LIGHTS	
■ WARNING BUZZER OR CHIME	50-74
■ DOOR LOCK CYLINDER & IGNITION KEY CYLINDER LIGHTS	
■ POWER STEERING CONTROL SYSTEM	50-78
■ AUTO ADJUSTING SUSPENSION CONTROL SYSTEM	50-80
■ SLIDING SUNROOF	50-84
■ REAR WINDOW DEFROSTER	50-86
■ POWER WINDOW	50-88
■ REMOTE CONTROL MIRROR	
■ CIGARETTE LIGHTER	50-90
■ CRUISE CONTROL SYSTEM	50-92
■ THEFT-DETERRENT SYSTEM	50-94
■ AUDIO SYSTEM	
■ POWER ANTENNA	50-96
■ POWER DOOR LOCK SYSTEM	50-102
■ ANTI-LOCK BRAKE SYSTEM	50-104
■ CONVERTIBLE TOP CONTROL SYSTEM	50-108
■ PARTS LOCATION	50-112
■ FRONT HARNESS	50-114
■ ENGINE HARNESS	50-116
■ EMISSION HARNESS	50-117
■ INSTRUMENT PANEL HARNESS	50-118
■ REAR HARNESS	50-119
■ GROUND CIRCUIT	50-120

SYSTEM NAME

SYSTEM	PAGE	SYSTEM	PAGE
HOW TO USE THIS WIRING DIAGRAM	50- 3	WARNING & AUTO CLOCK SYSTEM	50- 70
SYMBOLS IN THIS WIRING DIAGRAM	50- 7	CARGO ROOM LIGHT	50- 74
HOW TO READ ELECTRIC PARTS	50- 8	COURTESY LIGHTS	50- 74
PARTS INDEX (ABBREVIATIONS)	50- 10	INTERIOR & SPOT LIGHTS	50- 74
POWER SYSTEM	50- 12	WARNING BUZZER OR CHIME	50- 74
ELECTRICAL WIRING SCHEMATIC	50- 14	DOOR LOCK CYLINDER & IGNITION KEY CYLINDER LIGHTS	50- 74
STARTING & CHARGING SYSTEM	50- 16	POWER STEERING CONTROL SYSTEM	50- 78
E.G.I. & EMISSION CONTROL & IGNITION SYSTEM	50- 22	AUTO ADJUSTING SUSPENSION CONTROL SYSTEM [A.A.S.]	50- 80
FUEL PUMP & SUB-ZERO STARTING ASSIST SYSTEM	50- 34	SLIDING SUNROOF	50- 84
COOLING FAN SYSTEM	50- 38	REAR WINDOW DEFROSTER	50- 86
METERS & WARNING SYSTEM	50- 40	POWER WINDOW	50- 88
FRONT WIPER & WASHER	50- 44	REMOTE CONTROL MIRROR	50- 90
REAR WIPER & WASHER	50- 46	CIGARETTE LIGHTER	50- 90
HEADLIGHTS	50- 48	CRUISE CONTROL SYSTEM	50- 92
RETRACTABLE HEADLIGHT	50- 50	THEFT-DETERRENT SYSTEM	50- 94
HEADLIGHT CLEANER	50- 50	AUDIO SYSTEM	50- 96
ILLUMINATION LIGHTS	50- 50	POWER ANTENNA	50- 96
COMBINATION LIGHTS	50- 54	POWER DOOR LOCK SYSTEM	50-102
LICENSE LIGHTS	50- 54	ANTI-LOCK BRAKE SYSTEM [A.B.S.]	50-104
STORAGE BOX LIGHTS	50- 54	CONVERTIBLE TOP CONTROL SYSTEM	50-108
GLOVE BOX LIGHT	50- 54	PARTS LOCATION	50-112
STOP LIGHTS	50- 58	FRONT HARNESS	50-114
HORN	50- 58	ENGINE HARNESS	50-116
TURN & HAZARD FLASHER LIGHTS	50- 60	EMISSION HARNESS	50-117
BACK-UP LIGHTS	50- 60	INSTRUMENT PANEL HARNESS	50-118
HEATER & AIR CONDITIONER	50- 64	REAR HARNESS	50-119
		GROUND CIRCUIT	50-120

The Way to View a Wiring Diagram

This Wiring Diagram is made up of circuit diagrams, connector diagrams, location diagrams, and harness diagrams.

The circuit diagrams are divided according to each system, and by using them, the wiring of each system's circuit can be understood.

Connector diagrams and location diagrams are divided according to vehicle harness, and the location diagrams are designed so that the connector locations and the circuit's course in the vehicle harnesses can be understood.

From the connector diagrams the connector shape and the arrangement of the pins used in the circuit diagrams can be understood.

In the circuit diagrams and the location diagrams the different kinds of harnesses are colored differently, which makes easy distinguishing.

The harness diagrams on the last page can be understood to indicate the connector shape for each harness, the wiring color, and each part and each turning point in the vehicle.

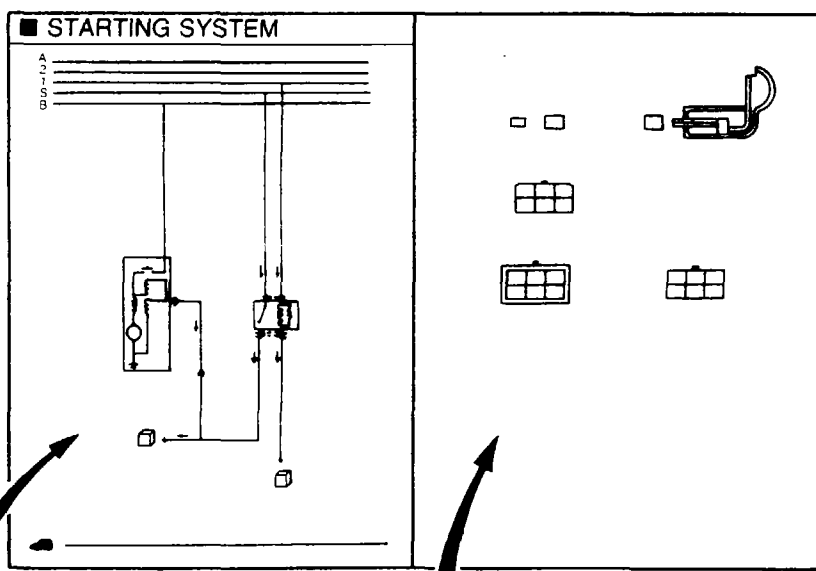

Circuit Diagram

Designed so that operation of electrical parts and the layout of the wiring may be understood.

Connector Diagram

Lists the connectors that are used in the circuit on the left page. As a rule, it shows the connectors on the harness side.

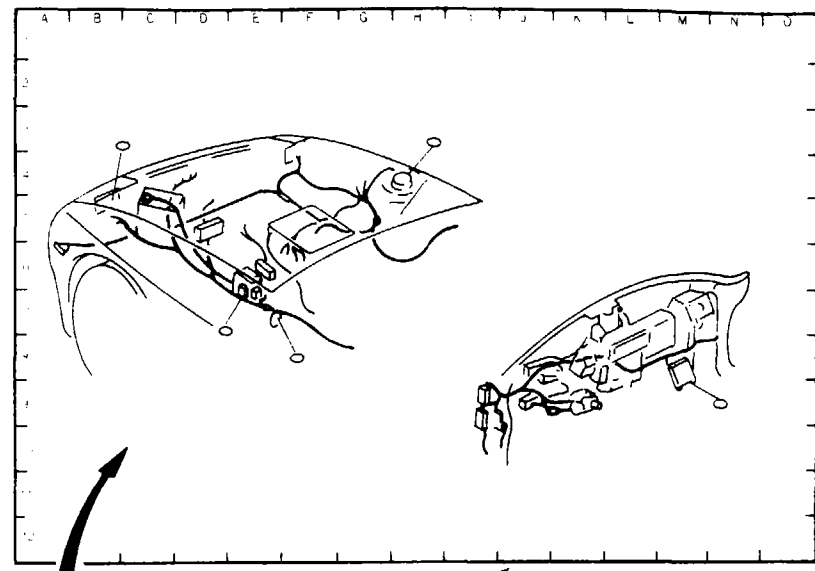

Location Diagram

This page illustrates the actual location of each connector and the routing diagram of the harness.

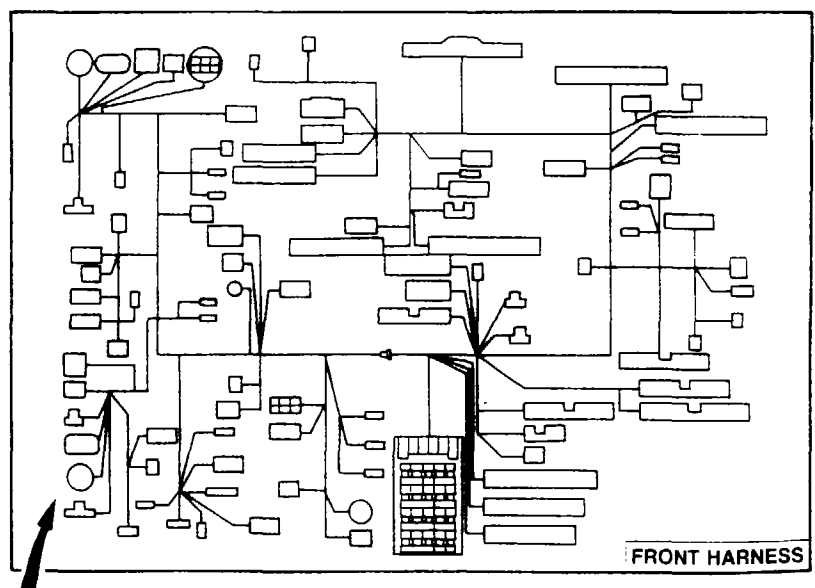

Harness Diagram

Indicate the connectors used in the circuit diagrams, arranging them according to each different kind of harness.

HOW TO USE THIS WIRING DIAGRAM

Overview of Power Source Diagrams and Ground Circuit Diagrams

The electrical power sources on the circuit are shown by designated code numbers. Therefore, by extending to the left the folding power source diagram, the power sources and fuse that are used be seen and understood at one glance.

Here are listed together the fuses that have been designated for use in the vehicle.

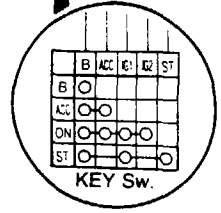
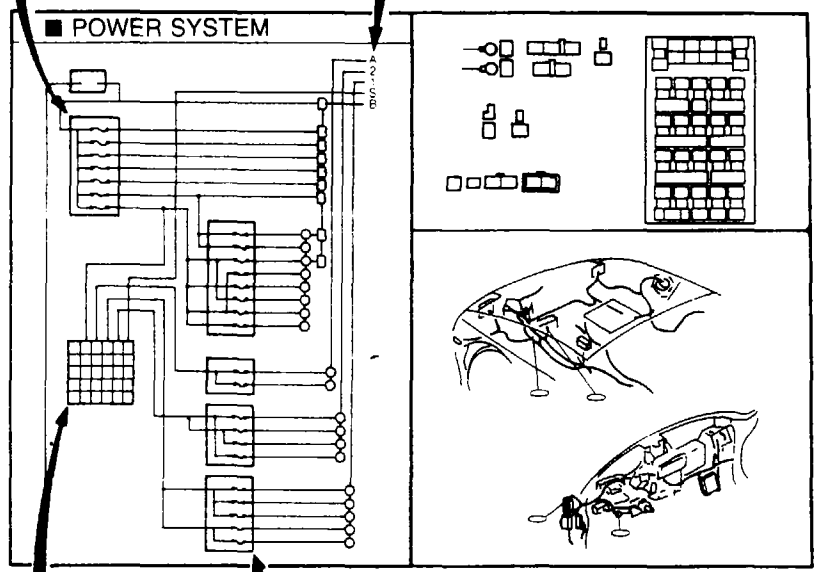
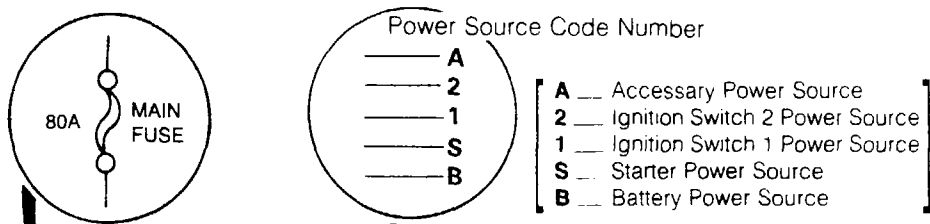

Ignition Switch

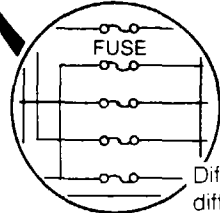

Different numbers indicate the different power sources. For example ACC has two power source, and each source has each number.

The ground locations are shown on the diagram.

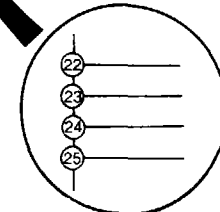
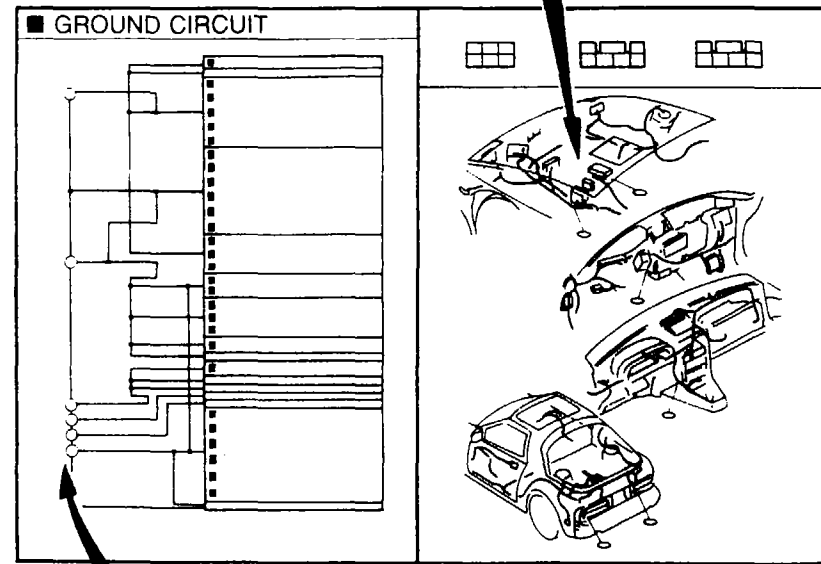

Made so the way in which each load is ground may be understood

Some Points to Remember When Viewing a Harness Diagram

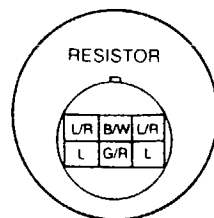

Designed in order that the connector shape and the arrangement of the pins used in the circuit diagrams might be understood.

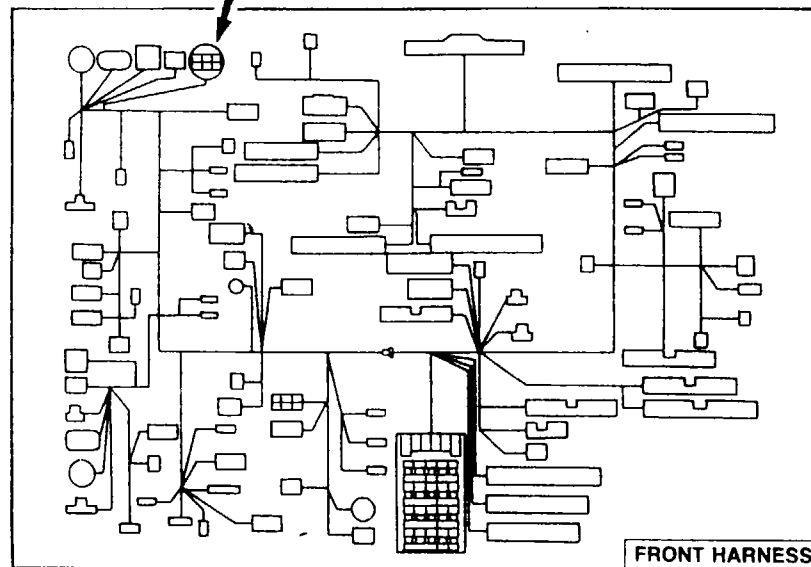

The way of looking at a connector

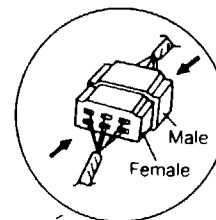
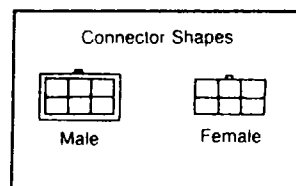

HARNESSES SYMBOLS

Each harness is distinguished by a symbol to indicate to which harness belong a wiring and connector in circuit diagrams and connector charts.

DESCRIPTION OF HARNESS	COLOR	SYMBOL	DESCRIPTION OF HARNESS	SYMBOL
Front harness	Black	[F]	Interior light harness	[In]
Engine harness	Red	[E]	Cluster switch harness (L.H.)	[Cr 1]
Instrument panel harness	Blue	[I]	Cluster switch harness (R.H.)	[Cr 2]
Rear harness	Green	[R]	No. 1 Door harness	[Dr 1]
Emission harness	Yellow	[EM]	No. 2 Door harness	[Dr 2]
Meter harness	Purple	[Me]	Air conditioner harness	[Ac 1]
Storage harness	Orange	[St]	Air conditioner harness	[Ac 2]
A.B.S. harness	Brown	[A]		

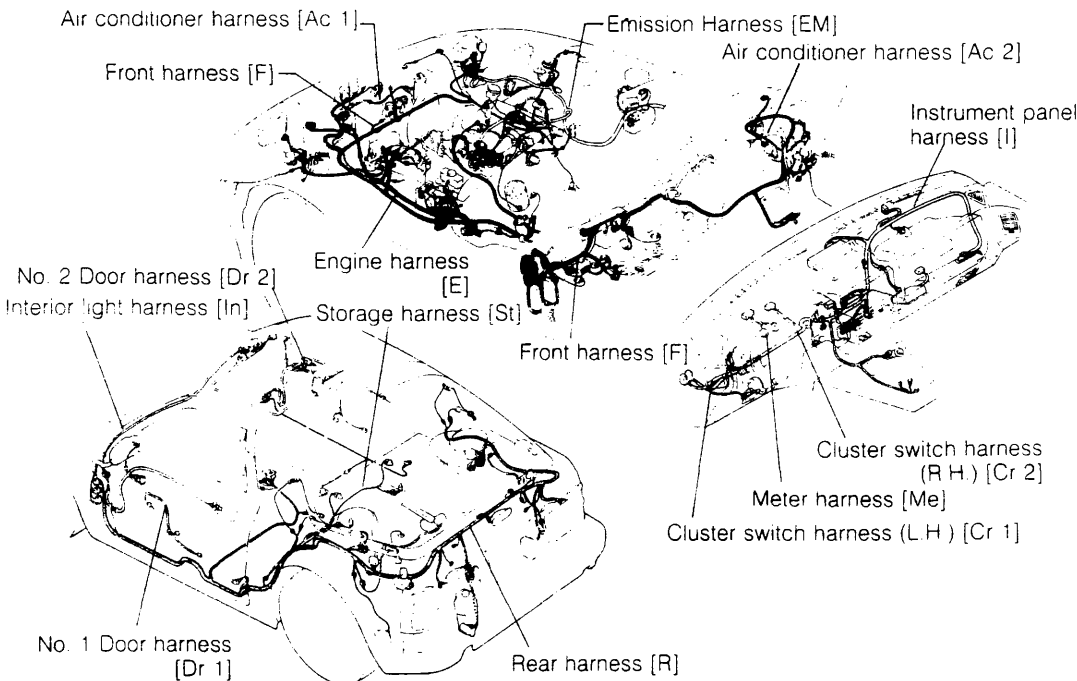

SYMBOLS IN THIS WIRING DIAGRAM

LOGICAL SYMBOLS

The logical symbols are of four kinds: OR, AND, INV. (Inverter), PROCESS. The circuit operation can be easily read by understanding these symbols.

OR



In case of input to either A or B, an output comes out from C. When A and B are off (0V), C is off (0V). When either A or B is on (12V), C is on (12V). This can be simply shown in the relay circuit on the right-hand side.

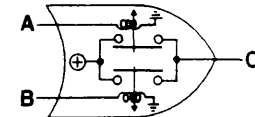

AND



In case on input to both A and B, an output comes out from C. When A and B are on (12V) C is on (12V). When either A or B is off (0V), C is off (0V). This can be simply shown in the relay circuit on the right-hand side.

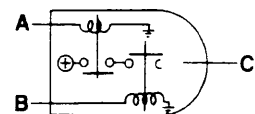

INV. (Inverter)

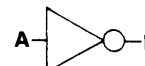

In case of input to A, B is grounded. When A is off (0V), B is on (12V). When A is on (12V), B is off (0V). This can be simply shown in the relay circuit on the right-hand side.

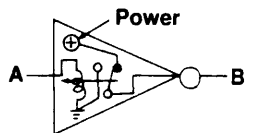

PROCESS



PROCESS makes a simplified representation of complicated functions of the circuit. Functions mainly used:
1. Detection of signals
2. Conversion of signals
The process of the full transistor ignition control unit is as shown in the right-hand figure.

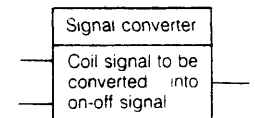

GRAPHIC SYMBOLS

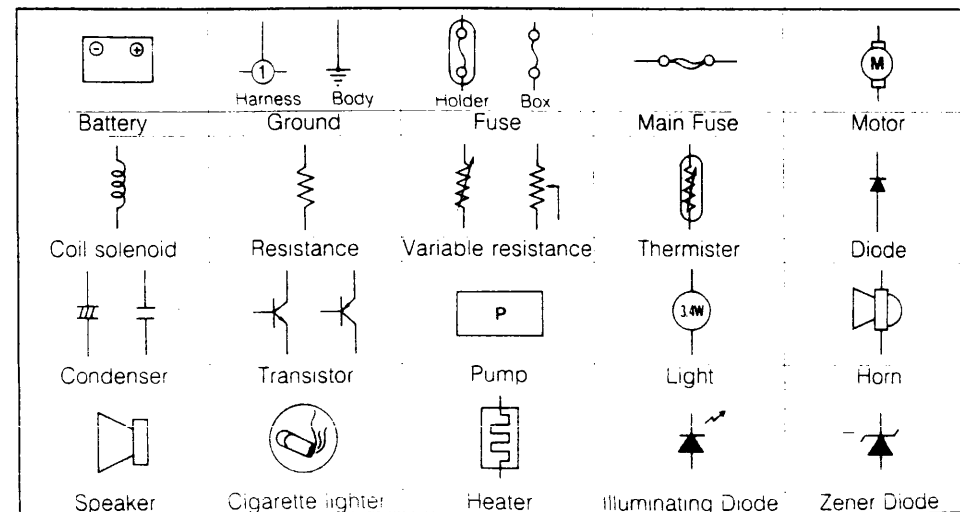

EXAMPLE OF CIRCUIT DIAGRAM

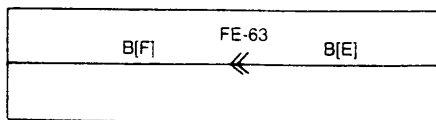





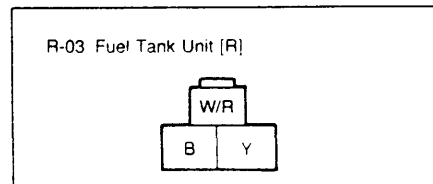































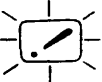

It is seen from the above that the male-side black line of the FE-63 shows the engine harness and the female-side black line shows the front harness.
It is seen from the above that the FE-63 connector is a connector connecting the engine and the front.

EXAMPLE OF CONNECTOR



It is seen from the above that this connector R-03 is for the Rear harness.

GRAPHIC SYMBOLS

					
Control Unit	Relay	Switch	Injector	Meter	Inhibitor Switch
					
Door Switch	Combination Switch	Air Conditioner	Solenoid Valve	Panel Light Control Switch	Auto Clock
					
Alternator	Boost Switch	Ignition Coil	Blower Motor Switch	Electric Fan Motor	Starting Motor
					
Parking Brake Switch	Magnet Clutch	Power Steering Angle Sensor	Radio	Tail Light Switch	Water Temp. Switch
					
A.A.S.	Power Antenna	Stop Light Switch			
					
Warning Light	Charge	Cooling Fan	Fuel	Coolant	High Beam Rear Fog
					
Hazard	Stop Light	Battery Electrolyte Low Level	Oil	Seat Belt	Sedimentor

AN OVERVIEW OF ELECTRICAL COMPONENTS

Following is an overview of electrical components representative of the many electrical components related to the control and warning instruments in automobiles.

DIODE



The nature of diode is to allow a current to flow in only one direction. It is used in a circuit when desiring to let current flow in only one direction, or as a rectifier when changing an alternating current to a direct current.

The different terminals of a diode are called anode (A) and cathode (K). Electric current flows from anode to cathode, but never from cathode to anode.

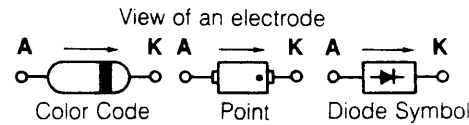

In checking a diode with a tester be careful about the tester's polarity. The tester's (-) means positive electrical potential, and (+) means negative electrical potential. To check a diode's current, Touch the tester's (-) lead to the anode, and the tester's (+) lead to the cathode.

ILLUMINATING DIODE

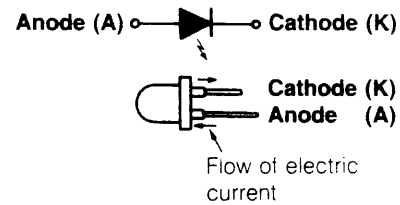

An illuminating diode emits light from the contact surface of a semiconductor when an electric current flows in its forward direction.

In setting the two battery in tester for the 10kΩ range, touch the tester's (-) lead to the anode (A), and the (+) lead to the cathode (K), it lights up.

RESISTOR

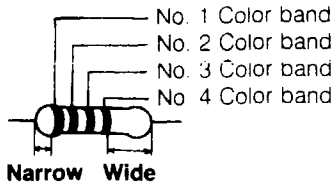

As resistors are essential to make an electric circuit. Reading the resistance value of the widely used resistor is explained below

As shown in the chart at left, there are four color bands to represent resistances. Each resistance value can be understood from each color band. For example:

Color Band	No. 1	No. 2	No. 3	No. 4
Color	Value	Value	Multiplier	Clearance
Black	0	0	$\times 10^0$	
Brown	1	1	$\times 10^1$	
Red	2	2	$\times 10^2$	
Orange	3	3	$\times 10^3$	
Yellow	4	4	$\times 10^4$	
Green	5	5	$\times 10^5$	
Blue	6	6	$\times 10^6$	
Purple	7	7	$\times 10^7$	
Gray	8	8	$\times 10^8$	
White	9	9	$\times 10^9$	
Gold			$\times 10^{-1}$	$\pm 5\%$
Silver			$\times 10^{-2}$	$\pm 10\%$
Non				$\pm 20\%$

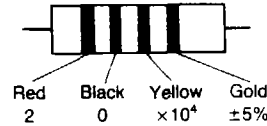

The resistance value is 200kΩ ± 5%

Code number clarification

The first two digits in each code number represent the resistance value, and the third digit represents multiplier. For example:

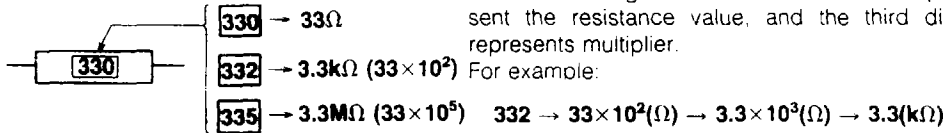

332 → $33 \times 10^2(\Omega) \rightarrow 3.3 \times 10^3(\Omega) \rightarrow 3.3(k\Omega)$

CONDENSER

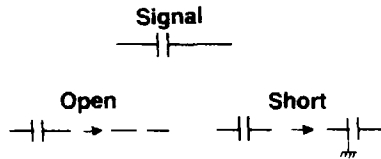

A Condenser is for storing electricity.

In the case of an open circuit, a condenser is not able to store electric charge. And the circuit remains in an open state.

A short circuit, its name indicate, means the break-down phenomena when voltage is applied.

Inspection of low voltage condenser with circuit tester

- (1) Short a condenser and discharge the remaining electric charge
- (2) Set $\times 10k\Omega$, largest resistance range in the circuit tester
- (3) When the test lead touches both ends, the indicate moves a little bit and then returns to $\infty(\Omega)$

TRANSISTOR

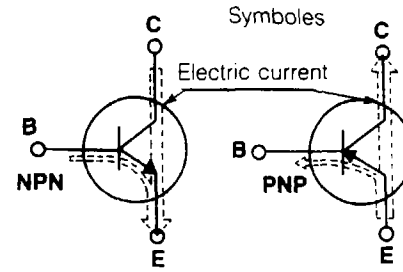

Electrodes indication

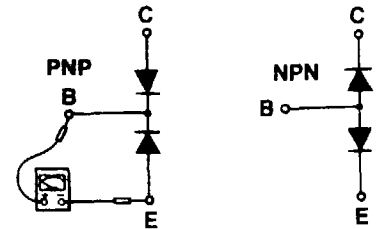
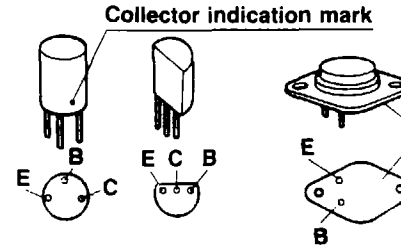

- Current Flow only C to B
- Current Flow only E to B
- Current Flow only B to C
- Current Flow only B to E

There are two types of transistor function:

- (1) Switching Acting a switch
- (2) Amplification action Amplifying a small signal to a big signal

Transistors are classified according to polarity (structure):

NPN and PNP

Generally, the NPN are widely used.

Transistor has three terminals: Emitter (E), Collector (C), and Base (B).

To operate the transistor, make a base current flow to the arrow direction (B to E). Then the resistance between the collector and the emitter becomes extremely small, and large current flows from the collector to the emitter (In the case of PNP transistor, electric current flows to the emitter to the collector).

Name of Models

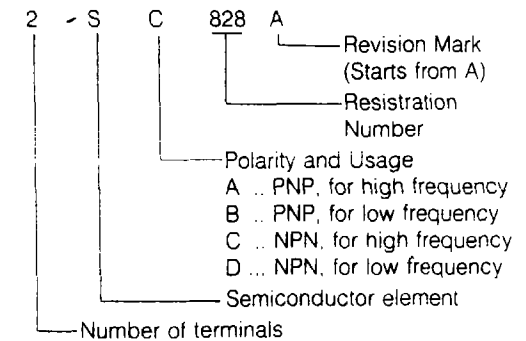

A simply way of checking

PNP and NPN transistor can be simplified shown in diagrams on the left-hand side.

Set $\times 100\Omega$ or $1k\Omega$, resistance measurement range in the circuit tester, and touch leads to each electrode to check conductivity

ABBREVIATIONS

ABBREVIATIONS USED IN THIS BOOKLET

A.	Ampere	HI.	High
A.A.S.	Auto Adjusting Suspension	I.S.C.	Idle Speed Control
A.B.S.	Anti-lock Brake System	IG.	Ignition
A.C.V.	Air Control Valve	ILLUMI.	Illumination
A.E.	Acoustic Equilibration	INT.	Intermittent
A.I.S.	Air Injection System	J.B.	Joint Box
A.S.	Auto Stop	L.H.	Left Hand
A.S.V.	Air Supply Valve	LCD.	Liquid Crystal Display
A/C	Air Conditioner	LO.	Low
A/F	Air Fuel	LW	Low Wave
A/R	Auto Reverse	M.	Motor
A/T	Automatic Transmission	M.I.L.	Mulfanction Indicator Light
ACC.	Accessory	M.T.R.	Mechanical Tuning Radio
ACCEL.	Accelerator	M/T	Manual Transmission
ADD.	Additional	MI	Middle
ALT.	Alternator	MIN.	Minute
AM	Amplitude Modulation	MIX.	Mixture
AMP.	Amplifier	MPX.	Multiplex
ANT.	Antenna	MTX	Manual Transaxle
ATP.	Atmospheric Pressure	MW	Middle Wave
ATX.	Automatic Transaxle	NC	Normally Closed
B.	Battery	NO	Normally Open
B.A.C	By-pass Air Control Valve	O.D.	Over Drive
B/L	Bi-Level	P.	Power
C.P.U.	Central Processing Unit	P.R.C.V.	Pressure Regulator Control
C.S.D	Cold Start Device	Solenoid Valve	
CARB	Carburator	P T C	Positive Temperature
CCT.	Circuit	Coefficient Heater	
CIGAR.	Cigarette	P/S	Power Steering
COMBI.	Combination	PRG.	Purge Solenoid Valve
CON.	Conditioner	Q.S.S.	Quick Start System
CONT.	Control	R	Rear
D.O.H.C.	Double Over Head Camshaft	R.H.	Right Hand
DEF	Defroster	R.L	Rear Left
E.C.E.	Economic Commission For Europe	R P M	Revolution Per Minute
E.G.I	Electric Gasoline Injection	R R	Rear Right
E.G.R	Exhaust Gas Recirculation	REC	Recirculation
E.G.R.P.	Exhaust Gas Recirculation	SOL	Solenoid
Pressure Sensor		SQ.	Square Per Milimeter
E.L.R.	Emergency Locking Retractor	ST.	Start
ELEC.	Electric	SW	Short Wave
ETR.	Electronic Tuner	SW	Switch
EXH.	Exhaust	T.C.V	Twin Scrol Turbocharger
F.	Front	Solenoid Valve	
F.I.C.B	Fast Idle Cam Breaker	T.I.C.S	Triple Induction Control System
F.L.	Front Left	TEMP	Temperature
F.R	Front Right	TR.	Transistor
F/B	Feed Back	V	Volt
F/I	Fuel Injector	V.R.I.S.	Variable Resonance Induction
FM	Frequency Modulation	System	
GEN	Generator	VENT	Ventilation
H.E.I	High Energy Ignition	VOL	Volume
H/D	Heat/Defroster	W.	Watt
HEAT	Heater		

PARTS	PAGE	PARTS	PAGE
A A S control switch	50-80	Convertible top motor	50-108
A A S control switch illumination light	50-80	Convertible top switch	50-108
A A.S. control unit	50-80	Courtesy lights	50-74
A.B.S control unit	50-104	Coolant level sensor	50-40
A.B.S hydraulic unit	50-104	Coolant level unit	50-40
A B S. sensor	50-104	Crank angle sensor	50-22 28
Accelerator switch	50-80	Cruise control switch	50-92
Actuator	50-80 92	Cruise control unit	50-92
ADD coolant warning light	50-70		
Additional horn	50-94	Dimmer relay	50-48
Air by-pass relay	50-31	Dimmer switch	50-48 60
Air by-pass solenoid valve	50-25 31	Diode	50-18 25 38 92
Air con. main relay	50-64 67	Door lock cylinder light	50-74
Air flow meter	50-25 31	Door switch	50-74
Air mix motor	50-64 67	Door handle switch	50-74
Air supply valve (ASV)	50-25	Door lock link switch	50-94
Anti-lock warning light	50-70	Door key cylinder switch	50-94
ALT warning light relay	50-16 18	Door speaker	50-96 99
Alternator	50-16 18	Door warning light	50-70
Atmospheric pressure sensor (ATP)	50-25 31	Door woofer amp	50-96 99
Auto clock	50-71		
		E G R solenoid valve	50-25 31
Back-up lights	50-60	Electrical fan sub relay	50-38
Back-up light switch	50-60	Electrical fan relay	50-38
Battery	50-12	Electronic control switch	50-64 67
Belt warning light	50-70	Emission control unit	50-22 25 28 31
Blower resistor	50-64 67	EX-HI relay	50-64 67
Blower motor	50-64 67		
Blower unit	50-64 67	Fan amp	50-64 67
Boost gauge	50-40	Front parking lights	50-54 60
Boost sensor	50-31	Front side marker light	50-54
Brake pressure switch	50-80	Front speaker	50-96 99
Brake warning light	50-70	Front washer motor	50-44
Brake fluid level sensor	50-71	Front washer switch	50-44
Buzzer	50-108	Front wiper motor	50-44
By-pass air control valve (BAC)	50-25 31	Front wiper switch	50-44
		Fuel gauge	50-40
Cargo room light	50-74	Fuel pump	50-34 36
Central processing unit	50-74	Fuel pump circuit terminal	50-25 31
Check connector	50-22 25 26 31 108	Fuel pump relay & fuel pump resistor	50-34
Charge warning light	50-70	Fuel tank unit	50-40
Cigarette lighter	50-90	Fuel warning light	50-70
Circuit opening relay	50-34 36	Fuse	50-12
Clutch switch	50-92		
Coil with igniter (T)	50-22 28	Glove box light	50-54
Coil with igniter (L)	50-22 28	Glove box light switch	50-54
Compact disc player	50-96 99		
Coolant level sensor	50-40	Hazard switch	50-60
Coolant level unit	50-40	Hazard & flasher unit	50-60
Cooling fan motor	50-38	Hatchback door switch	50-74
Cooling fan control unit	50-38	Hatchback warning light	50-70
Cooling fan indicator light	50-40	Headlight	50-48
Cooling fan warning light	50-70	Headlight relay	50-48
Combination meter	50-40	Headlight cleaner switch	50-50
Condenser	50-22 26 40	Headrest speaker	50-99

PARTS	PAGE	PARTS	PAGE
Headrest speaker box	50-99	Over drive indicator	50-18
Heater relay	50-64 67	Over drive oil pressure switch	50-28
Headlight cleaner motor	50-50	Overheat warning light	50-70
Heat hazard switch	50-22 28	Over top switch	50-25 28
High mounted stop light	50-58		
High beam	50-40	Panel light control	50-50
Hood switch	50-94	Parking brake switch	50-70
Horn	50-58	Port air solenoid valve	50-25, 31
Horn relay	50-58	Power antenna relay	50-96 99
Horn switch	50-58	Power door lock motor	50-102
		Power door lock relay	50-102
IG relay	50-67	Power door lock switch	50-102
Ignition key cylinder light	50-74	Power steering control unit	50-78
Ignition key reminder switch	50-74	Power steering relay	50-25
Ignition switch	50-71	Power steering switch	50-25 28
Inhibitor switch	50-18, 60	Power transistor	50-64, 67
Injector	50-22, 28	Power window motor	50-88
Intake air temp sensor	50-25, 31	Power window switch	50-88
Interior light	50-74	Power window main switch	50-88
Inter lock switch	50-16, 18	Pressure gauge	50-40
Intermittent wiper relay	50-44, 46	Pressure sensor	50-25
Illumination light		Pressure regulator control solenoid valve (PRCV)	50-25 31
Cigarette	50-50		
Meter	50-40	Radio	50-96 99
Turn	50-40	Rear hatch key cylinder switch	50-94
Hazard	50-60	Rear side marker lights	50-54
Wiper & washer	50-44	Rear speaker	50-96 99
Cruise	50-92	Rear washer motor	50-46
Rear wiper & washer	50-46	Rear wiper motor	50-46
		Rear wiper switch	50-46
Kick down solenoid	50-18	Rear washer switch	50-46
Kick down switch	50-18	Rear window defroster relay	50-86
Knock control unit	50-25	Rear window defroster switch	50-86
Knock sensor	50-25	Rear window defroster	50-86
		Rec-fresh select motor	50-64, 67
License lights	50-45	Relief solenoid valve	50-25, 31
Light switch	50-50	Refrigerant pressure switch	50-64, 67
Lock-up relay	50-18	Remote control mirror	50-90
Lock-up solenoid	50-18	Remote control mirror switch	50-90
		Retractable headlight motor	50-50
Main fuse	50-12		
Magnet clutch	50-64, 67	Seat belt switch	50-74
Main relay	50-22, 28	Security indicator light	50-94
Mode control motor	50-64, 67	Shift indicator light	50-40
Mode control switch	50-64, 67	Sliding sunroof switch	50-84
		Sliding sunroof motor	50-84
Neutral switch	50-22, 28	Speed sensor	50-40
		Split air solenoid valve	50-25, 31
Oil level sensor	50-71	Spot light	50-74
Oil pressure gauge unit	50-40	Starter cut relay	50-16, 18
Oil pressure gauge	50-40	Starting motor	50-16, 18
Oil level warning light	50-70	Stepping motor	50-78
O ₂ sensor	50-25, 31	Stop light	50-58, 92
Over drive cancel solenoid	50-18	Stop light switch	50-58
Over drive control switch	50-18		

PARTS	PAGE	PARTS	PAGE
Stop light warning light	50-58	Turn switch	50-60
Stop light warning relay	50-58	Twin scroll turbocharger solenoid valve (TCV)	50-25
Storage box light	50-54	Vacuum switch	50-18
Storage box light switch	50-54	Variable resistor	50-25, 31
Sub-zero motor	50-34 36	Volt gauge	50-40
Sub-zero sensor	50-34, 36		
Sunroof relay	50-84	Warning & auto clock unit	50-71
Switching solenoid valve	50-25 31	Washer fluid level sensor	50-71
		Water temp switch	50-22, 28, 38
Tachometer	50-40	Water temp gauge unit	50-40
Tail lights	50-54	Water thermo sensor	50-25, 31
Theft-deterrent control light	50-94	Washer warning light	50-70
Thermostat	50-64 67		
Throttle sensor	50-25 31	20000 Miles switch	50-40
Temp. gauge	50-40	4AT control unit	50-18
Turn cancel sensor	50-60, 80	4AT relay	50-18
Turn & hazard flasher light	50-60	4-3 switch	50-18
Turn indicator light	50-40		

POWER SYSTEM

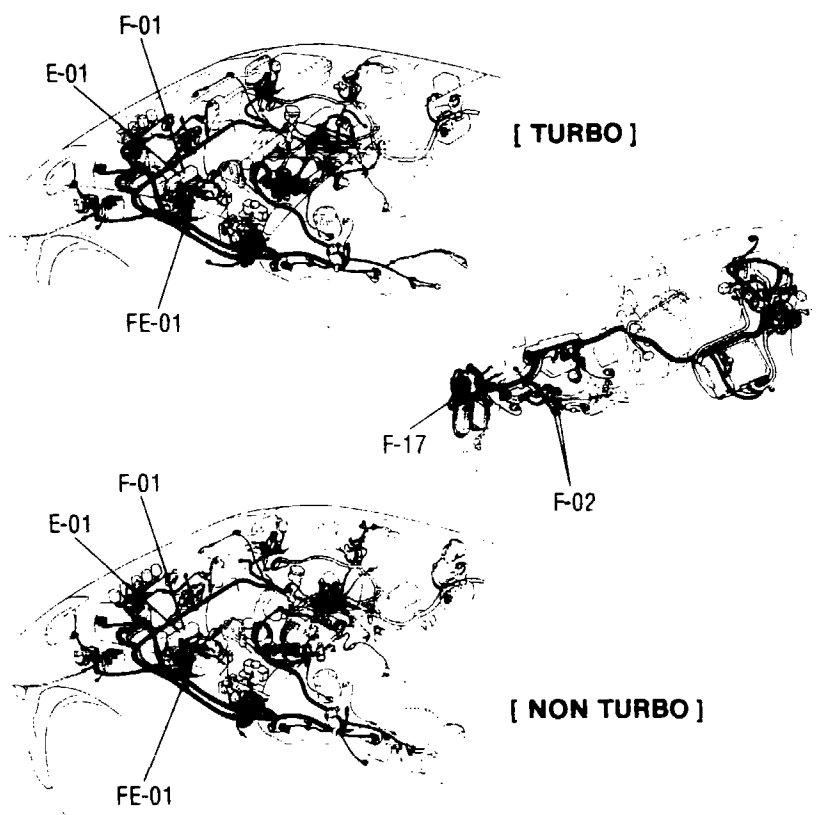
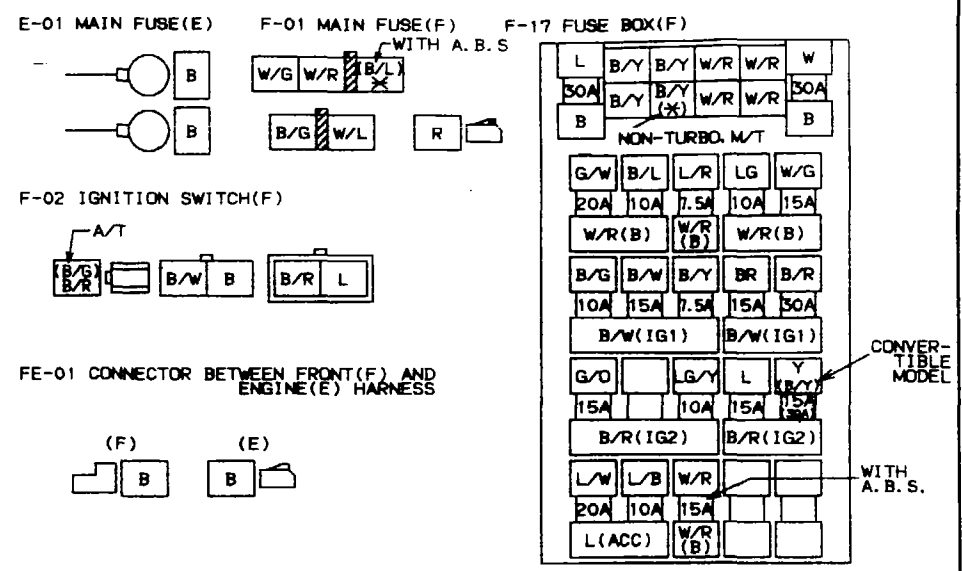
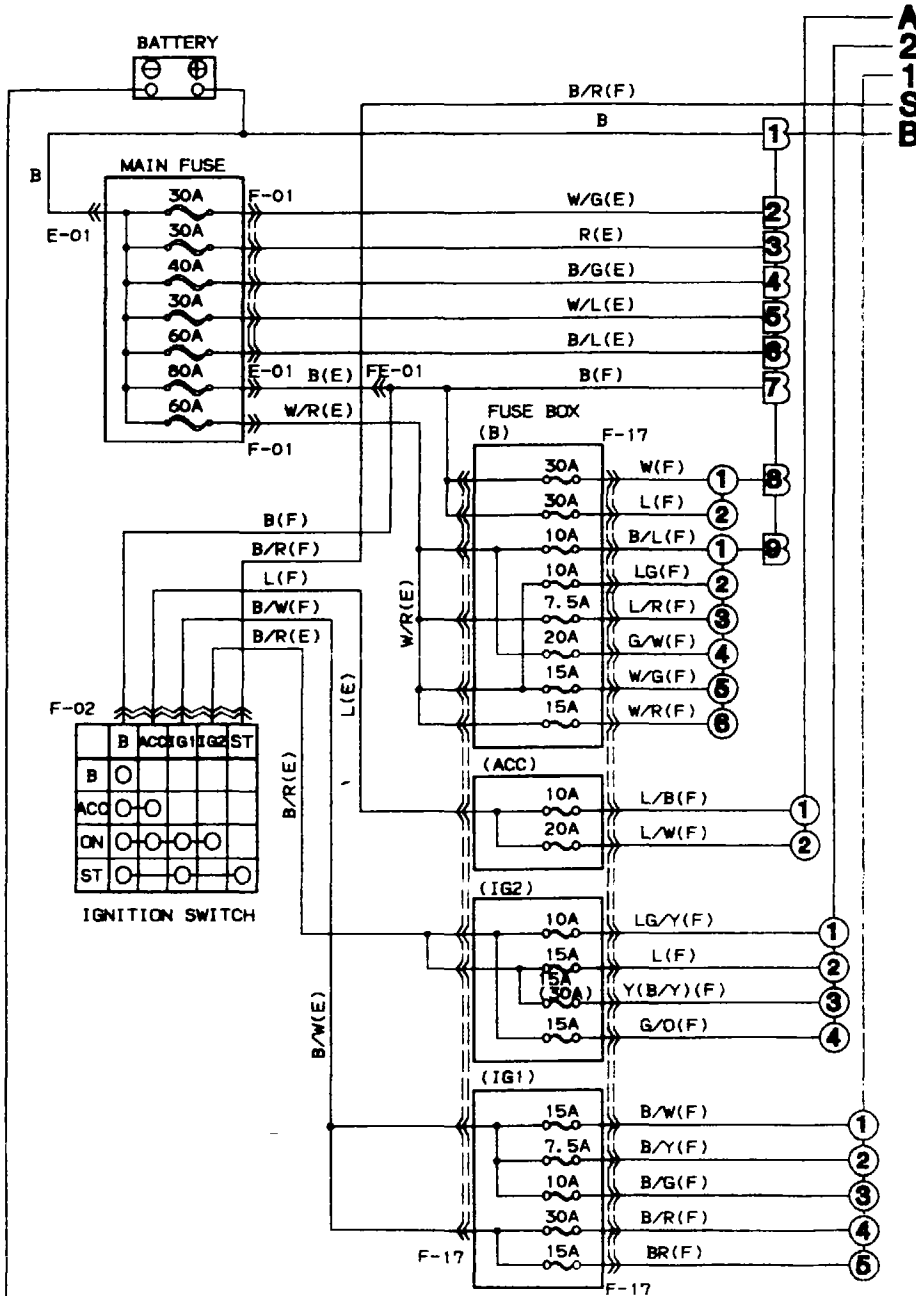

[TURBO] ELECTRICAL WIRING SCHEMATIC

NOTE:
 - - - - - CURRENT FROM BATTERY
 - - - - - CURRENT FROM IG1 TERMINAL OF IGNITION SWITCH
 - - - - - CURRENT FROM IG2 TERMINAL OF IGNITION SWITCH
 - - - - - CURRENT FROM ACC TERMINAL OF IGNITION SWITCH
 - - - - - OTHERS

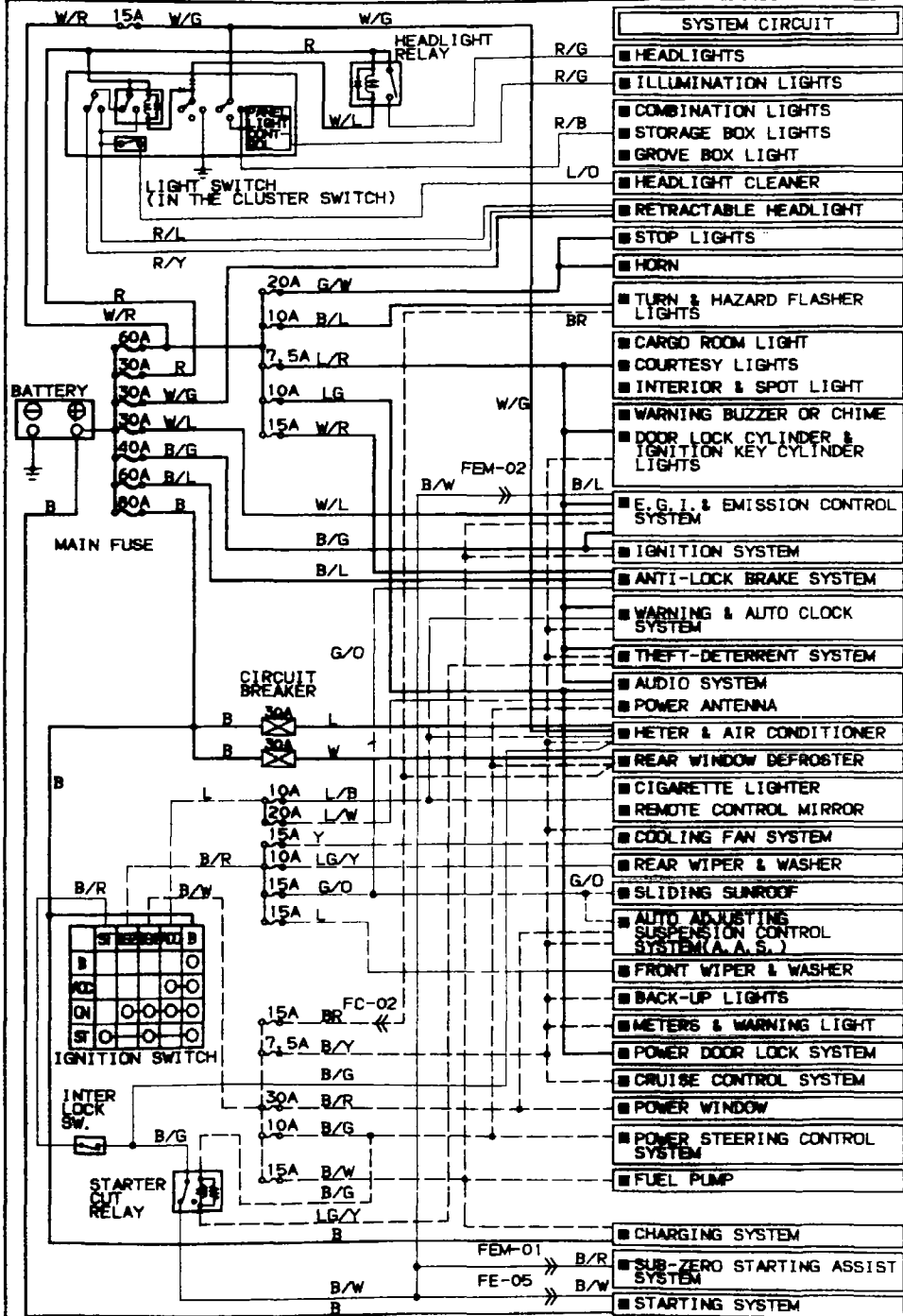

- SYSTEM CIRCUIT**
- HEADLIGHTS
 - ILLUMINATION LIGHTS
 - COMBINATION LIGHTS
 - STORAGE BOX LIGHTS
 - GROVE BOX LIGHT
 - HEADLIGHT CLEANER
 - RETRACTABLE HEADLIGHT
 - STOP LIGHTS
 - HORN
 - TURN & HAZARD FLASHER LIGHTS
 - CARGO ROOM LIGHT
 - COURTESY LIGHTS
 - INTERIOR & SPOT LIGHT
 - WARNING BUZZER OR CHIME
 - DOOR LOCK CYLINDER & IGNITION KEY CYLINDER LIGHTS
 - E.G.I. & EMISSION CONTROL SYSTEM
 - IGNITION SYSTEM
 - ANTI-LOCK BRAKE SYSTEM
 - WARNING & AUTO CLOCK SYSTEM
 - THEFT-DETERRENT SYSTEM
 - AUDIO SYSTEM
 - POWER ANTENNA
 - METER & AIR CONDITIONER
 - REAR WINDOW DEFROSTER
 - CIGARETTE LIGHTER
 - REMOTE CONTROL MIRROR
 - COOLING FAN SYSTEM
 - REAR WIPER & WASHER
 - SLIDING SUNROOF
 - AUTO ADJUSTING SUSPENSION CONTROL SYSTEM (A.A.S.)
 - FRONT WIPER & WASHER
 - BACK-UP LIGHTS
 - METERS & WARNING LIGHT
 - POWER DOOR LOCK SYSTEM
 - CRUISE CONTROL SYSTEM
 - POWER WINDOW
 - POWER STEERING CONTROL SYSTEM
 - FUEL PUMP
 - CHARGING SYSTEM
 - SUB-ZERO STARTING ASSIST SYSTEM
 - STARTING SYSTEM

FEM-01 CONNECTOR BETWEEN FRONT(F) AND EMISSION(EM) HARNESS

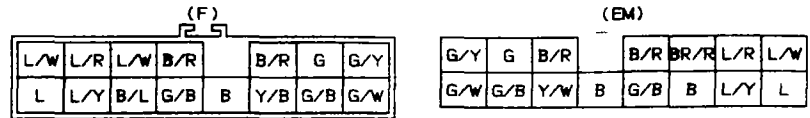

FEM-02 CONNECTOR BETWEEN FRONT(F) AND EMISSION(EM) HARNESS

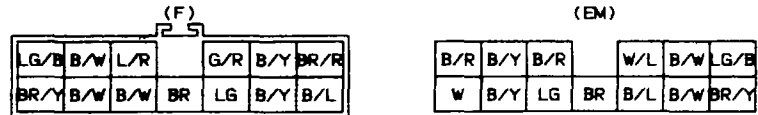

FC-02 CONNECTOR BETWEEN FRONT(F) AND CLUSTER SWITCH(CR1) HARNESS

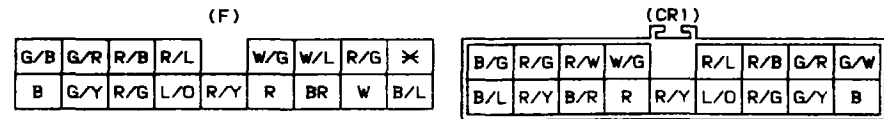

FE-05 CONNECTOR BETWEEN FRONT(F) AND ENGINE(E) HARNESS



NOTE: *...NOT USED

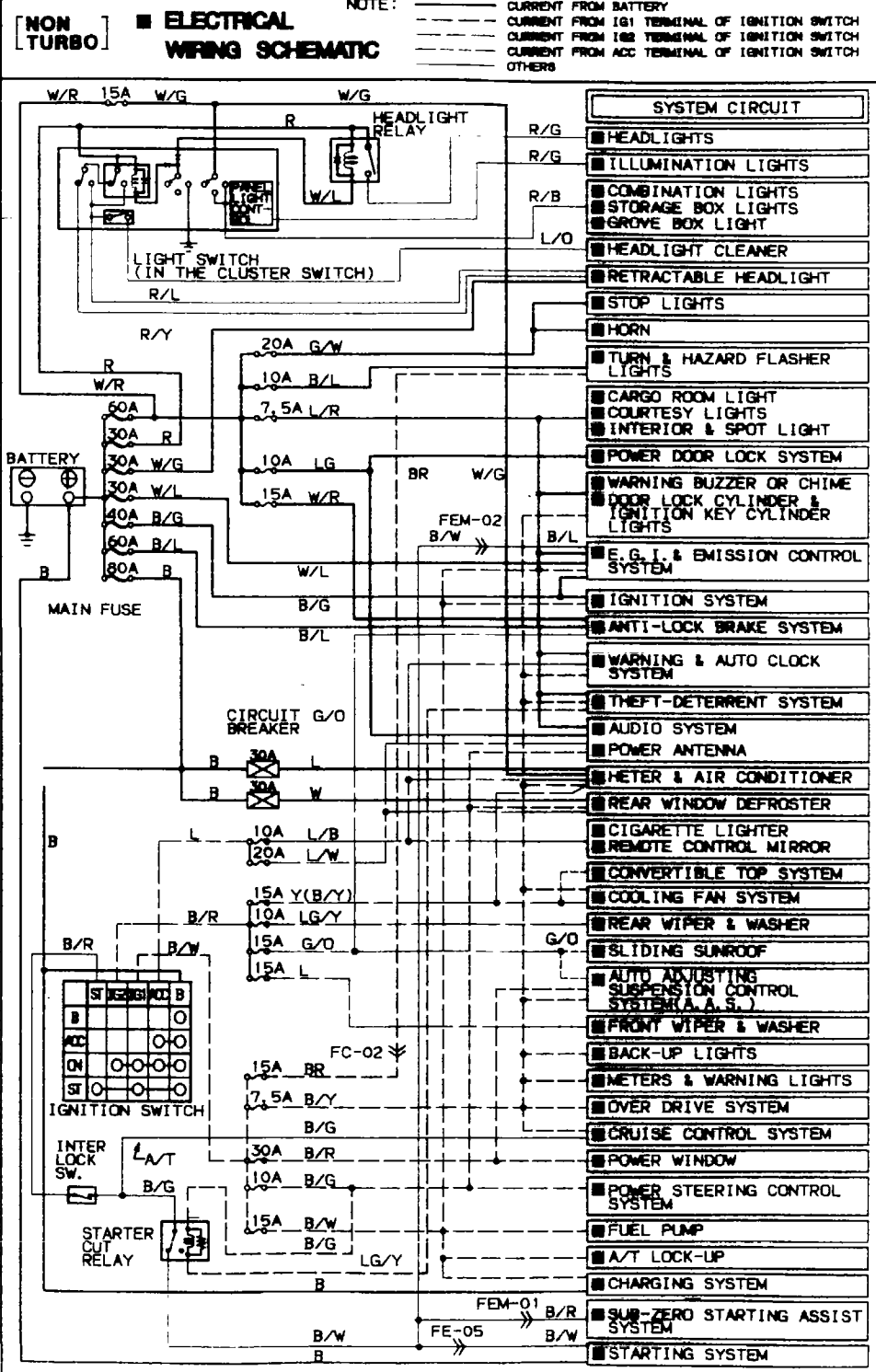

- SYSTEM CIRCUIT**
- HEADLIGHTS
 - ILLUMINATION LIGHTS
 - COMBINATION LIGHTS
 - STORAGE BOX LIGHTS
 - GROVE BOX LIGHT
 - HEADLIGHT CLEANER
 - RETRACTABLE HEADLIGHT
 - STOP LIGHTS
 - HORN
 - TURN & HAZARD FLASHER LIGHTS
 - CARGO ROOM LIGHT
 - COURTESY LIGHTS
 - INTERIOR & SPOT LIGHT
 - POWER DOOR LOCK SYSTEM
 - WARNING BUZZER OR CHIME
 - DOOR LOCK CYLINDER & IGNITION KEY CYLINDER LIGHTS
 - E. G. I. & EMISSION CONTROL SYSTEM
 - IGNITION SYSTEM
 - ANTI-LOCK BRAKE SYSTEM
 - WARNING & AUTO CLOCK SYSTEM
 - THEFT-DETERRENT SYSTEM
 - AUDIO SYSTEM
 - POWER ANTENNA
 - METER & AIR CONDITIONER
 - REAR WINDOW DEFROSTER
 - CIGARETTE LIGHTER
 - REMOTE CONTROL MIRROR
 - CONVERTIBLE TOP SYSTEM
 - COOLING FAN SYSTEM
 - REAR WIPER & WASHER
 - SLIDING SUNROOF
 - AUTO ADJUSTING SUSPENSION CONTROL SYSTEM (A. A. S.)
 - FRONT WIPER & WASHER
 - BACK-UP LIGHTS
 - METERS & WARNING LIGHTS
 - OVER DRIVE SYSTEM
 - CRUISE CONTROL SYSTEM
 - POWER WINDOW
 - POWER STEERING CONTROL SYSTEM
 - FUEL PUMP
 - A/T LOCK-UP
 - CHARGING SYSTEM
 - SUB-ZERO STARTING ASSIST SYSTEM
 - STARTING SYSTEM

FEM-01 CONNECTOR BETWEEN FRONT(F) AND EMISSION(EM) HARNESS

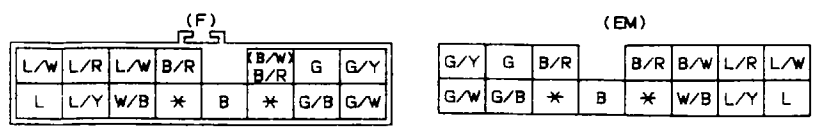

FEM-02 CONNECTOR BETWEEN FRONT(F) AND EMISSION(EM) HARNESS

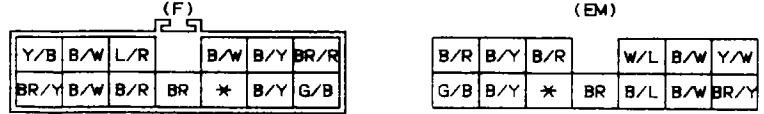

FC-02 CONNECTOR BETWEEN FRONT(F) AND CLUSTER SWITCH(CR1) HARNESS

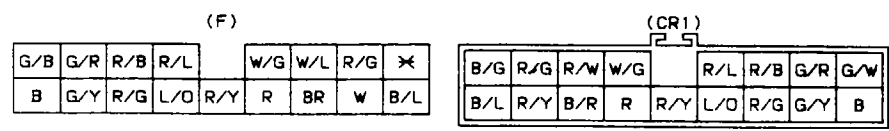

FE-05 CONNECTOR BETWEEN FRONT(F) AND ENGINE(E) HARNESS

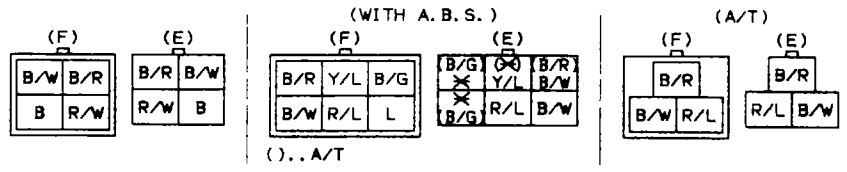

[TURBO] ■ STARTING & CHARGING SYSTEM

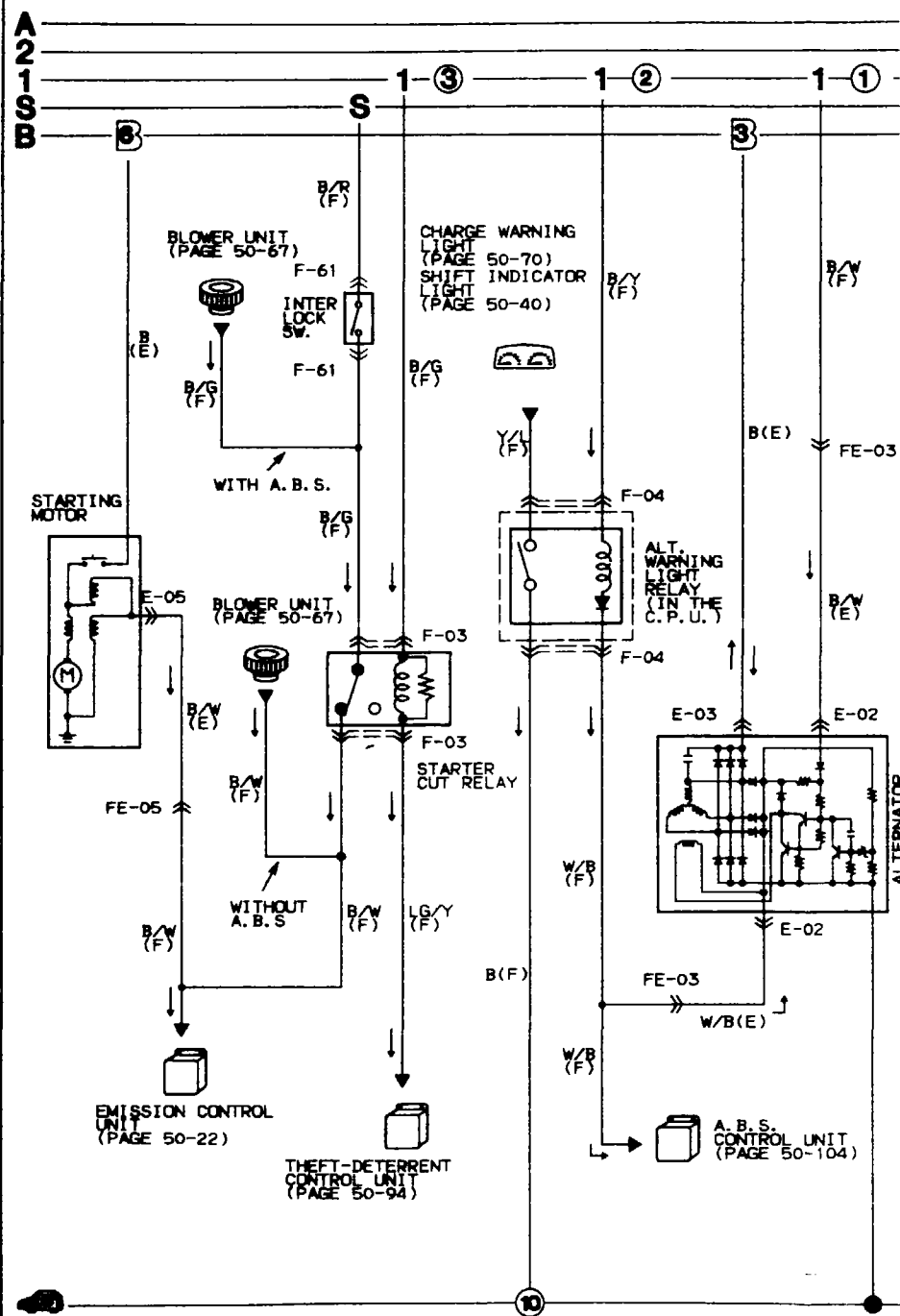

E-02 ALTERNATOR(E)



E-03 ALTERNATOR(E)



E-05 STARTING MOTOR(E)



F-03 STARTER CUT RELAY(F)

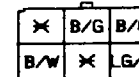

F-61 INTER LOCK SWITCH(F)



F-04 ALT. WARNING LIGHT RELAY(F)

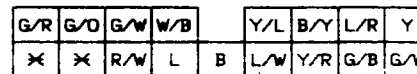

FE-03 CONNECTOR BETWEEN FRONT(F) AND ENGINE(E) HARNESS

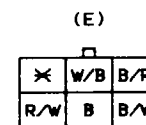
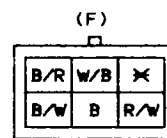

FE-02 CONNECTOR BETWEEN FRONT(F) AND ENGINE(E) HARNESS



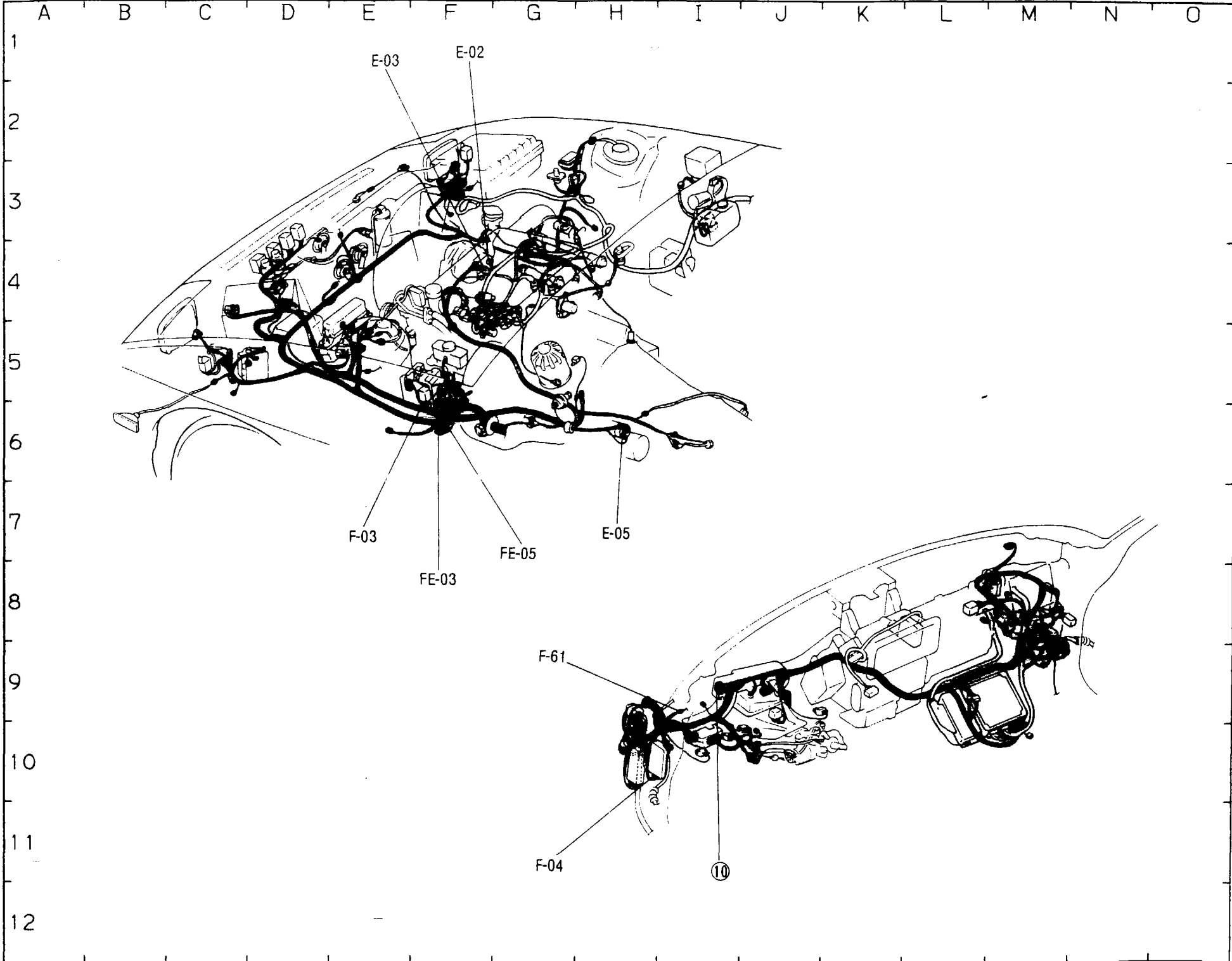

[NON TURBO]

▪ STARTING & CHARGING SYSTEM ▪ A/T LOCK-UP
▪ OVER DRIVE SYSTEM

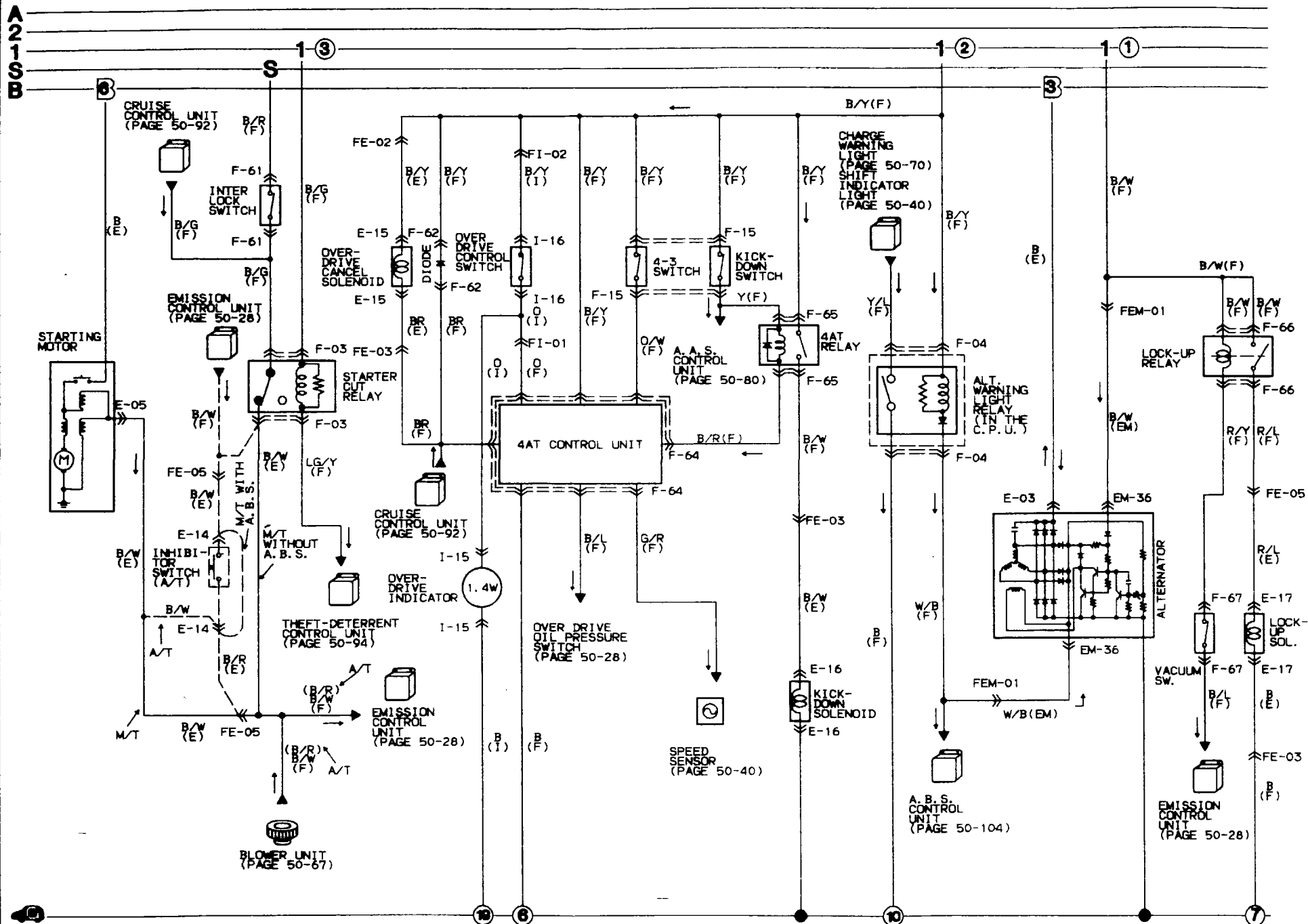

F-03 STARTER CUT RELAY(F)

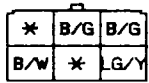

F-04 ALT. WARNING LIGHT RELAY(F)

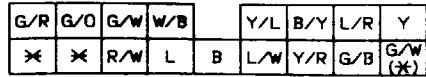

()...LOW GRADE MODEL

F-15 4-3 AND KICK-DOWN SWITCH(F)

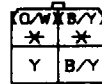

()...NON TURBO WITH A.B.S. OR A/T

F-61 INTER-LOCK SWITCH(F)



F-62 DIODE(F)

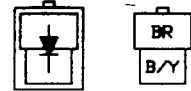

F-64 4AT CONTROL UNIT(F)



F-65 4AT RELAY(F)



F-66 LOCK-UP RELAY (F)

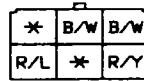

F-67 VACUUM SWITCH(F)



I-15 OVER DRIVE INDICATOR(I)



I-16 OVER DRIVE CONTROL SWITCH(I)



E-03 ALTERNATOR(E)



E-05 STARTING MOTOR



E-14 INHIBITOR SWITCH(E)

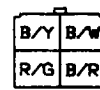

E-15 OVER DRIVE CANCEL SOLENOID(E)



E-16 KICK-DOWN SOLENOID(E)



E-17 LOCK-UP SOLENOID(E)



EM-36 ALTERNATOR(EM)



FE-02 CONNECTOR BETWEEN FRONT(F) AND ENGINE(E) HARNESS

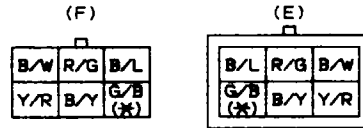

FE-03 CONNECTOR BETWEEN FRONT(F) AND ENGINE(E) HARNESS

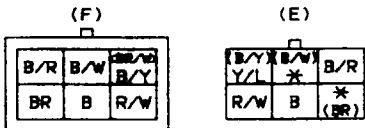

FE-05 CONNECTOR BETWEEN FRONT(F) AND ENGINE(E) HARNESS

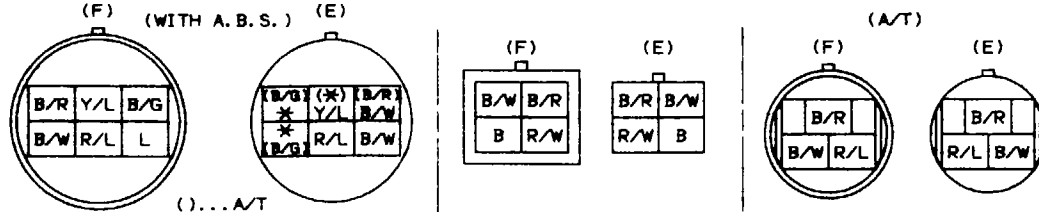

FI-01 CONNECTOR BETWEEN FRONT(F) AND INSTRUMENT PANEL(I) HARNESS

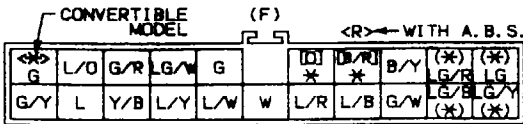

()...LOW GRADE MODEL []...A/T

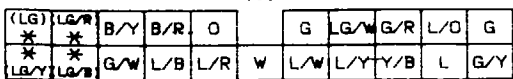

()...WITH COMPACT DISC

FI-02 CONNECTOR BETWEEN FRONT(F) AND INSTRUMENT PANEL(I) HARNESS

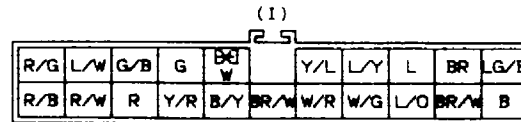
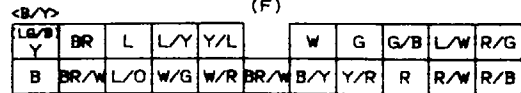

()...A/T & WITH A.B.S.
 <>...CONVERTIBLE MODEL
 []...WITH COMPACT DISC

FEM-01 CONNECTOR BETWEEN FRONT(F) AND EMISSION(EM) HARNESS

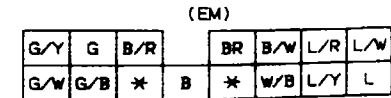
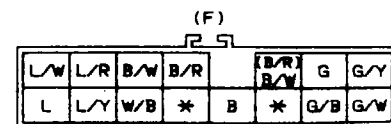

()...A/T & WITH A.B.S.

50 WIRING DIAGRAM

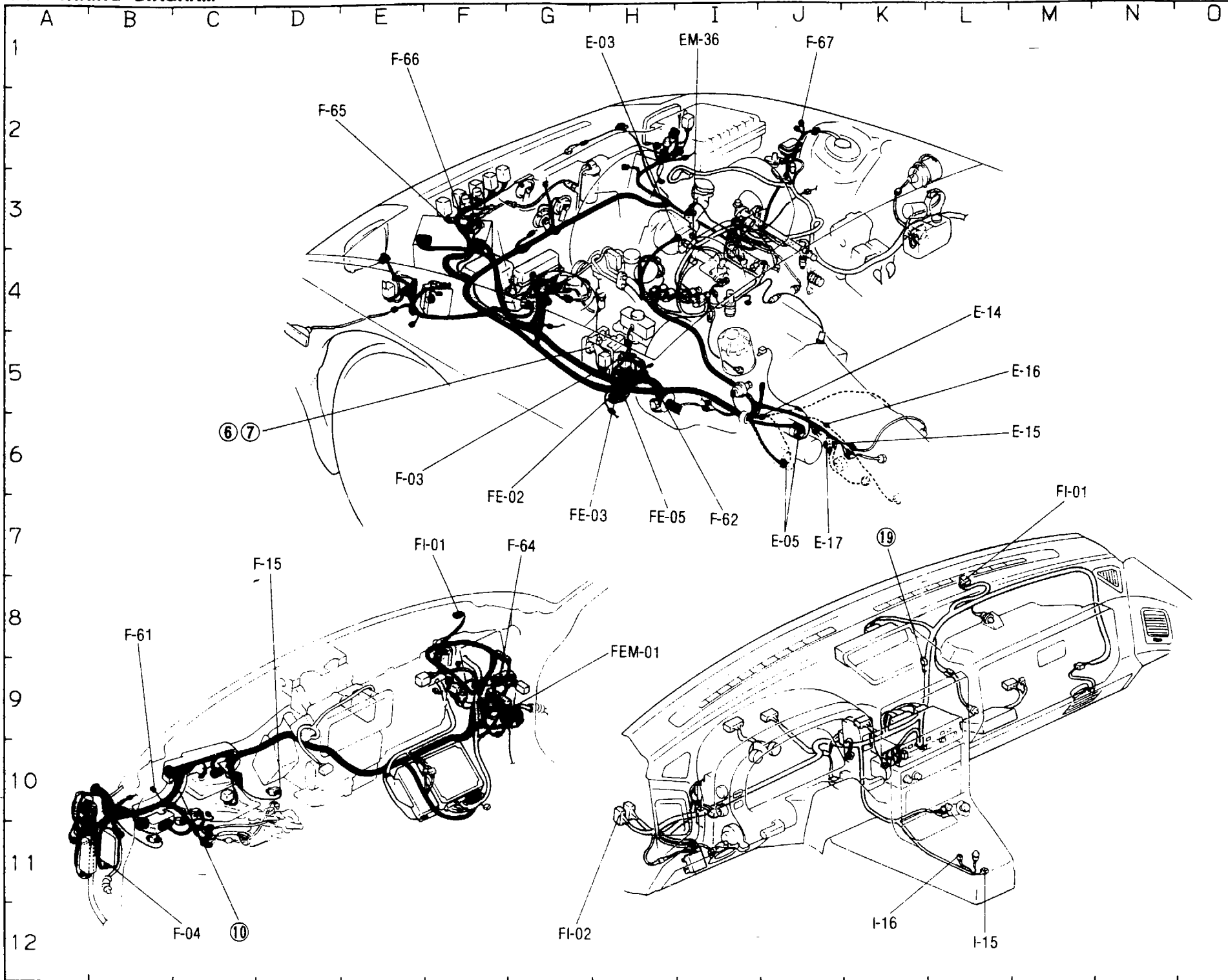

[TURBO] ■ E. G. I. & EMISSION CONTROL & IGNITION SYSTEM

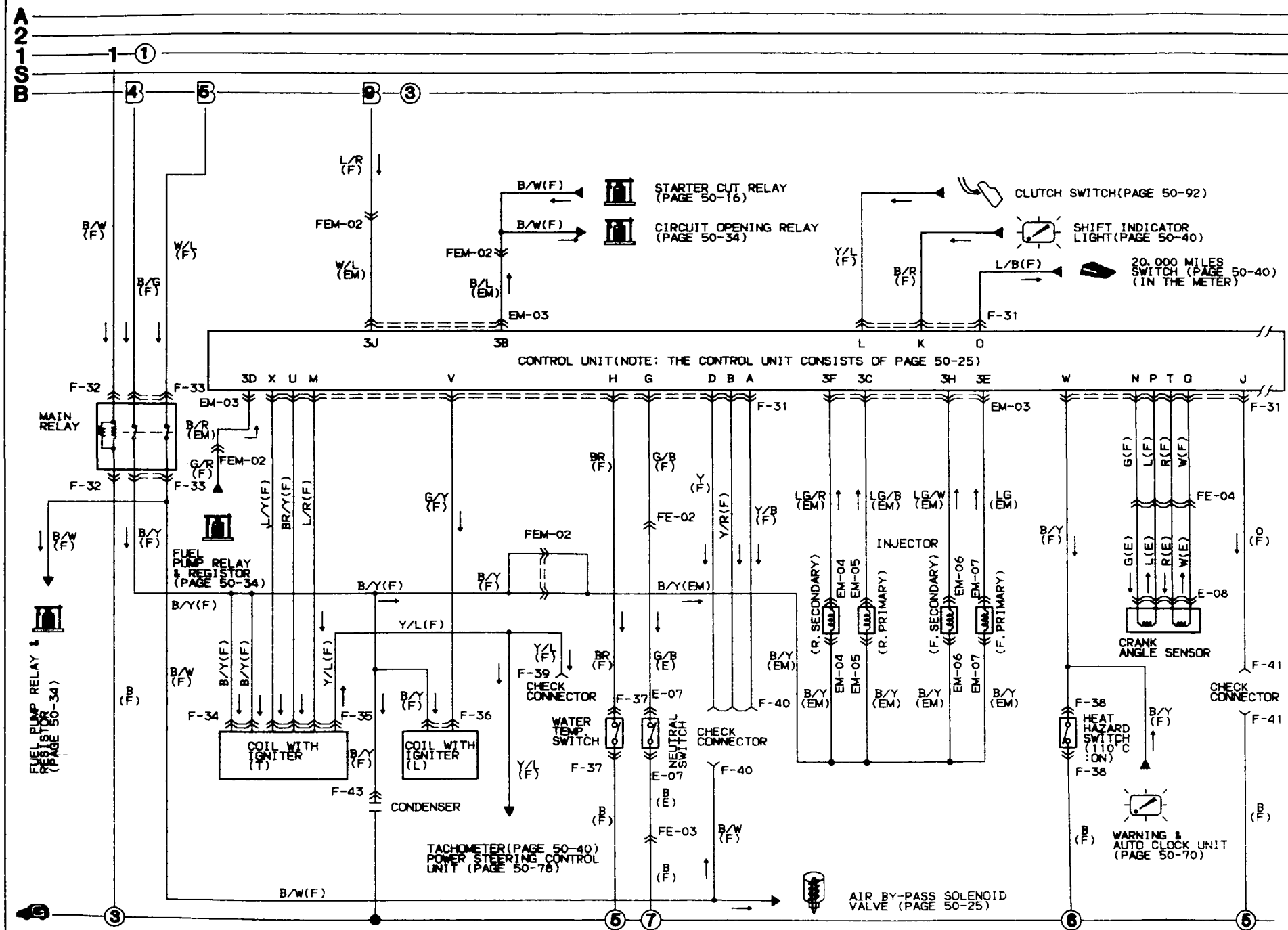

F-31 EMISSION CONTROL UNIT(F)

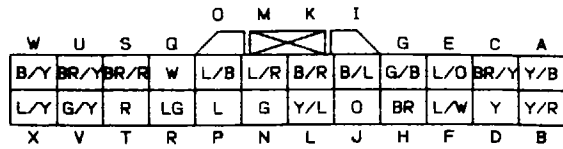

F-32 MAIN RELAY(F)

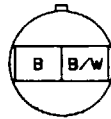

F-33 MAIN RELAY(F)

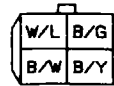

F-34 COIL WITH IGNITER(T)(F)

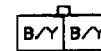

F-35 COIL WITH IGNITER(T)(F)



F-36 COIL WITH IGNITER(L)(F)



F-37 WATER TEMP. SWITCH(F)



F-38 HEAT HAZARD SWITCH(F)



F-39 CHECK CONNECTOR(F)



F-40 CHECK CONNECTOR(F)

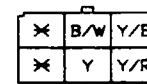

F-41 CHECK CONNECTOR(F)



F-43 CONDENSER(F)



E-07 NEUTRAL SWITCH(E)

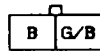

E-08 CRANK ANGLE SENSOR(E)

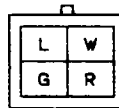

EM-03 EMISSION CONTROL UNIT(EM)

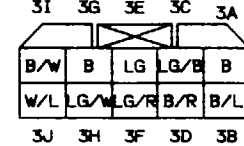

EM-04 INJECTOR(R. SECONDARY)(EM)



EM-05 INJECTOR(R. PRIMARY)(EM)

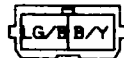

EM-06 INJECTOR(F. SECONDARY)(EM)

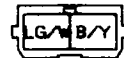

EM-07 INJECTOR(F. PRIMARY)(EM)

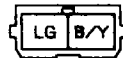

FE-02 CONNECTOR BETWEEN FRONT(F) AND ENGINE(E) HARNESS

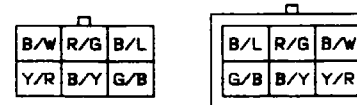

FE-03 CONNECTOR BETWEEN FRONT(F) AND ENGINE(E) HARNESS

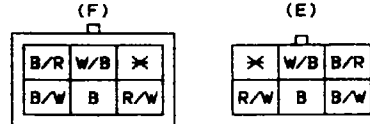

FE-04 CONNECTOR BETWEEN FRONT(F) AND ENGINE(E) HARNESS

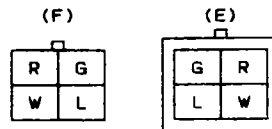

FEM-02 CONNECTOR BETWEEN FRONT(F) AND EMISSION(EM) HARNESS

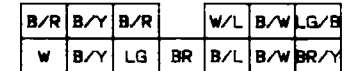

50 WIRING DIAGRAM

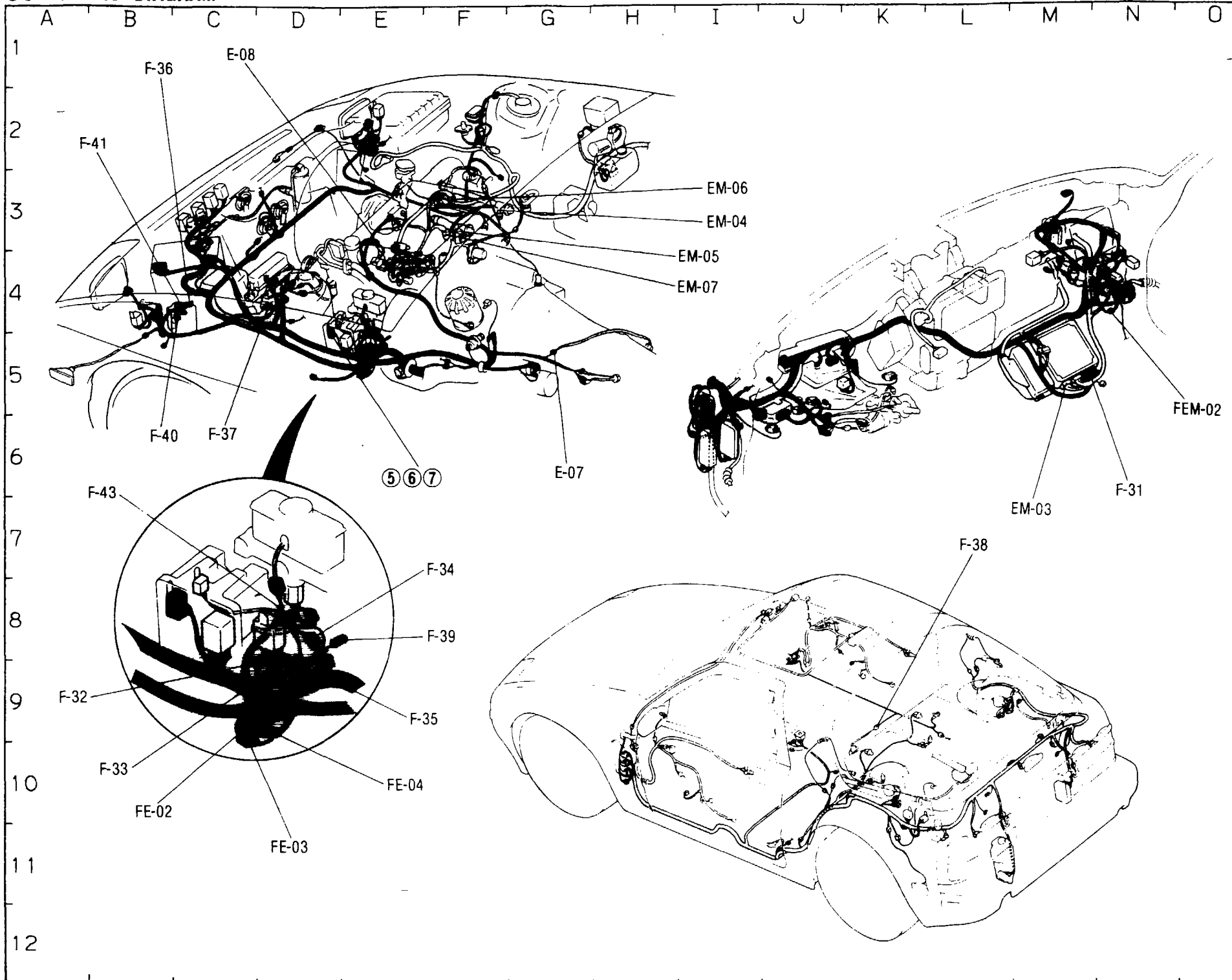

[TURBO] ■ E. G. I. & EMISSION CONTROL SYSTEM

A
2
1
S
B

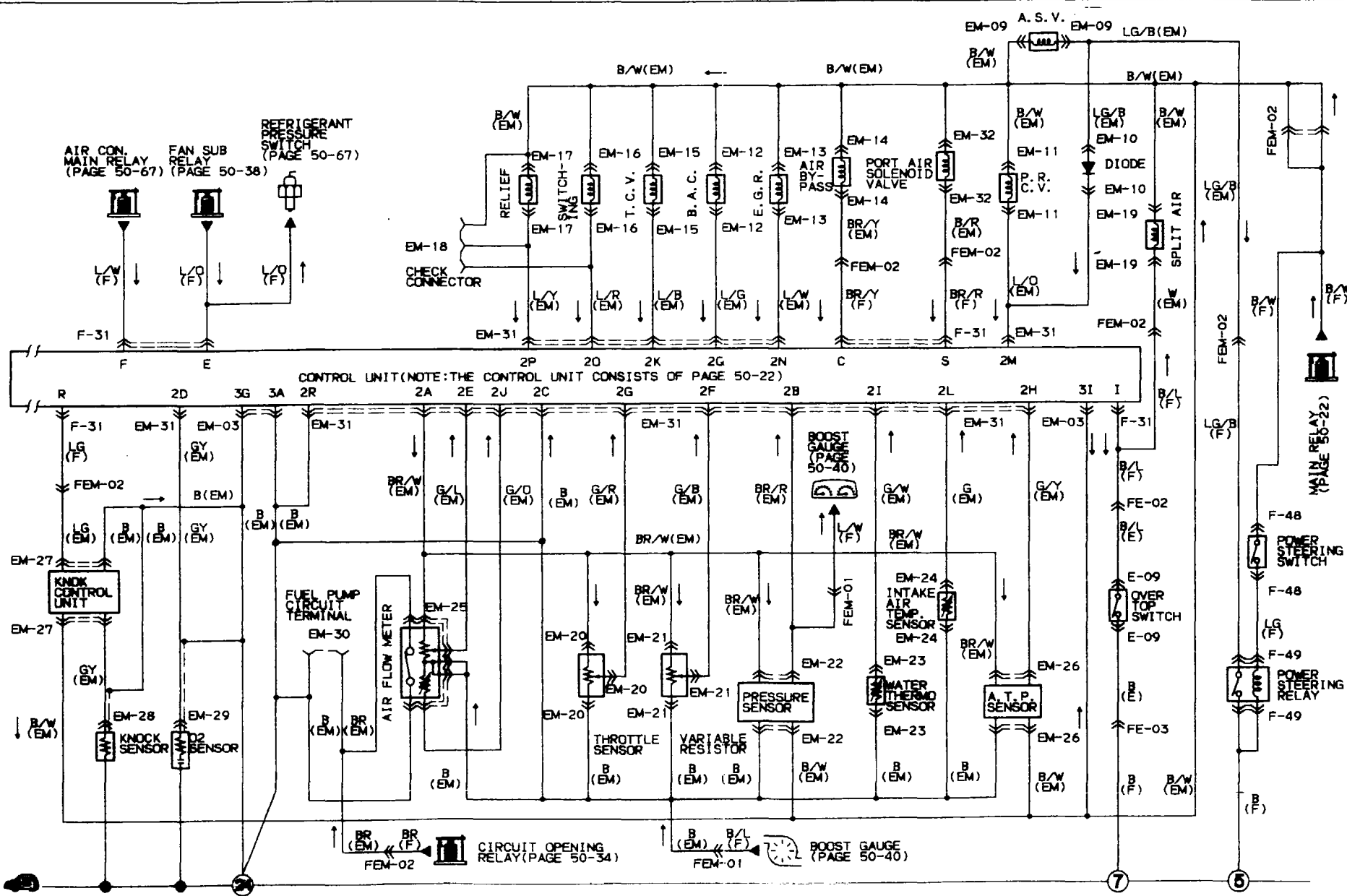

F-31 EMISSION CONTROL UNIT(F)

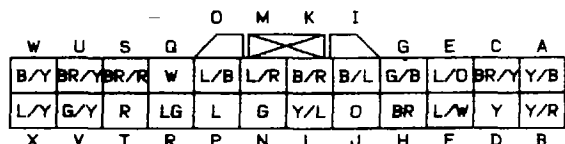

F-48 POWER STEERING SWITCH(F)



F-49 POWER STEERING RELAY(F)



E-09 OVER-TOP SWITCH(E)



EM-03 EMISSION CONTROL UNIT (EM)

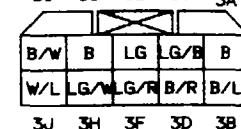

EM-09 AIR SUPPLY VALVE(EM)
(A.S.V.)



EM-10 DIODE(EM)

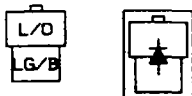

EM-11 PRESSURE REGULATOR CONTROL SOLENOID VALVE(EM)
(P.R.C.V.)

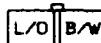

EM-12 BY-PASS AIR CONTROL VALVE(EM)
(B.A.C.)

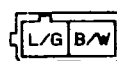

EM-13 E.G.R. SOLENOID VALVE(EM)



EM-14 AIR BY-PASS SOLENOID VALVE (EM)



EM-15 TWIN SCROLL TURBOCHARGER SOLENOID VALVE (T.C.V.) (EM)



EM-16 SWITCHING SOLENOID VALVE(EM)



EM-17 RELIEF SOLENOID VALVE(EM)

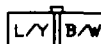

EM-18 CHECK CONNECTOR (EM)



EM-19 SPLIT AIR SOLENOID VALVE(EM)



EM-20 THROTTLE SENSOR(EM)



EM-21 VARIABLE RESISTOR (EM)

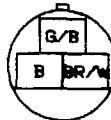

EM-22 PRESSURE SENSOR (EM)



EM-23 WATER THERMO. SENSOR(EM)

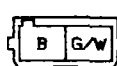

EM-24 INTAKE AIR TEMP. SENSOR(EM)



EM-25 AIR FLOW METER(EM)



EM-26 ATMOSPHERIC PRESSURE SENSOR (A.T.P.) (EM)

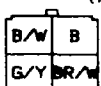

EM-27 KNOCK CONTROL UNIT (EM)

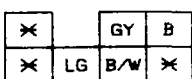

EM-28 KNOCK SENSOR(EM)



EM-29 O2 SENSOR(EM)



EM-30 FUEL PUMP CIRCUIT TERMINAL(EM)



EM-31 EMISSION CONTROL UNIT(EM)

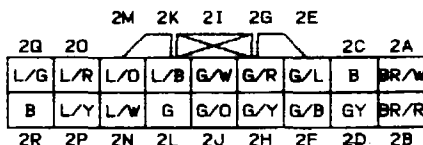

EM-32 PORT AIR SOLENOID VALVE(EM)



FE-02 CONNECTOR BETWEEN FRONT(F) AND ENGINE(E) HARNESS

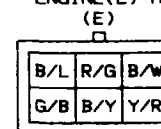
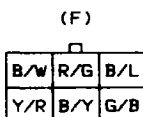

FE-03 CONNECTOR BETWEEN FRONT(F) AND ENGINE(E) HARNESS

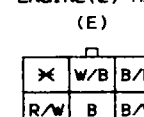
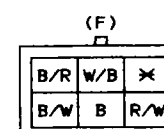

FEM-01 CONNECTOR BETWEEN FRONT(F) AND EMISSION(EM) HARNESS

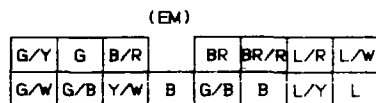
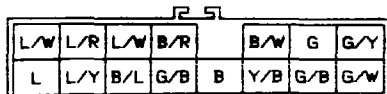

FEM-02 CONNECTOR BETWEEN FRONT(F) AND EMISSION(EM) HARNESS

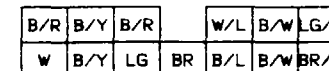
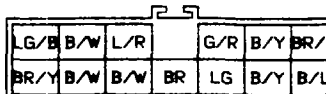

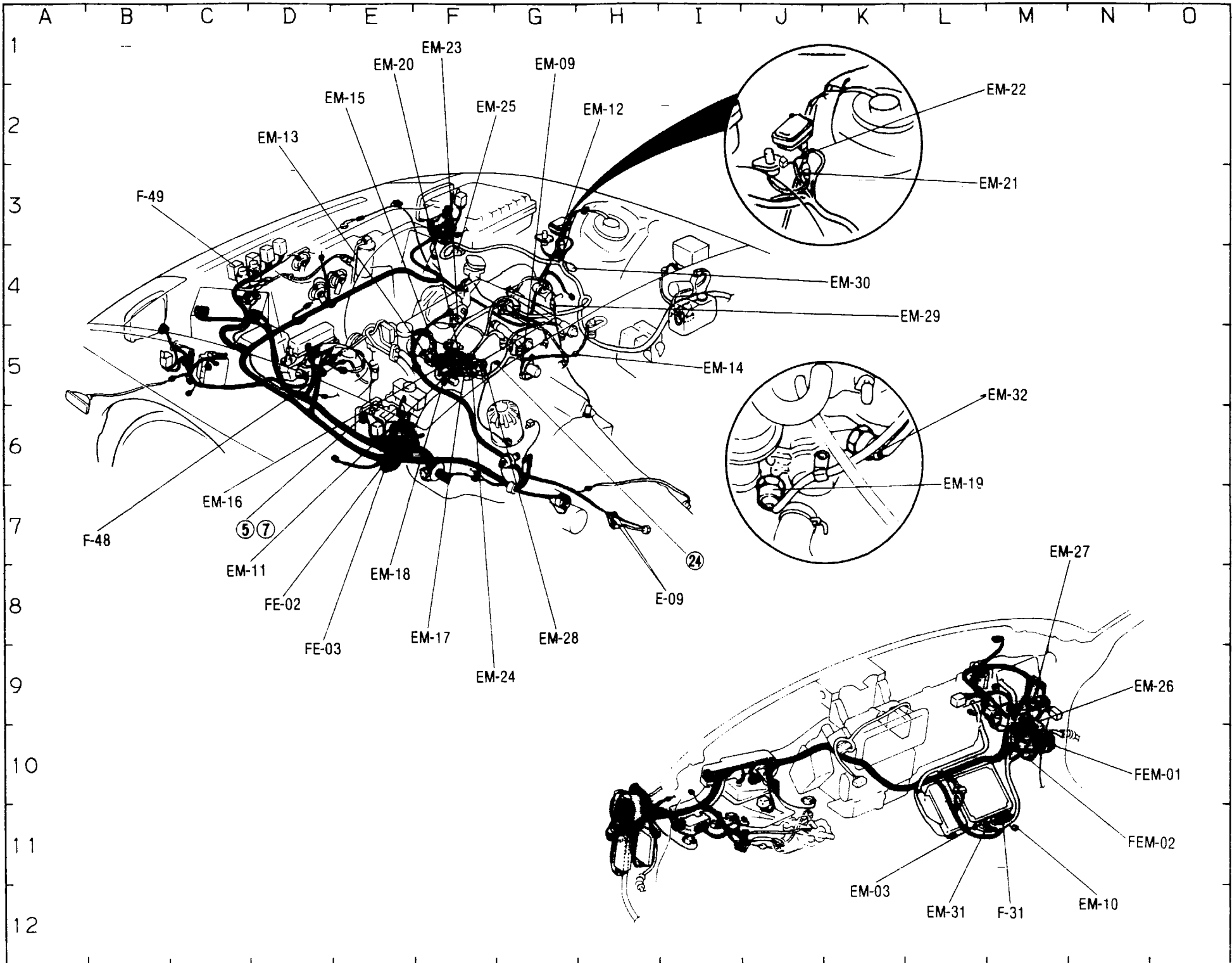

[NON TURBO] - E. G. I. & EMISSION CONTROL & IGNITION SYSTEM

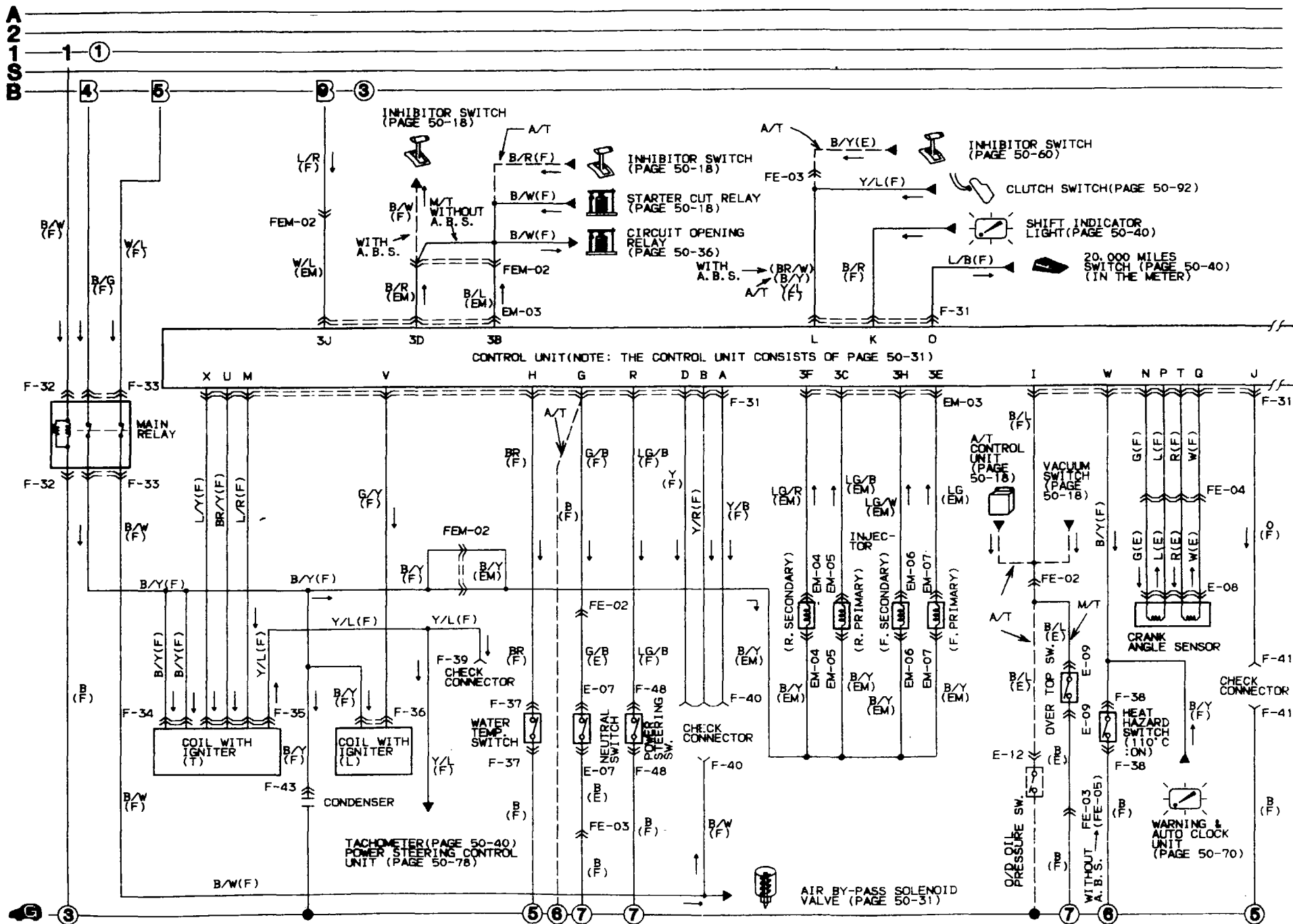

F-31 EMISSION CONTROL UNIT(F)

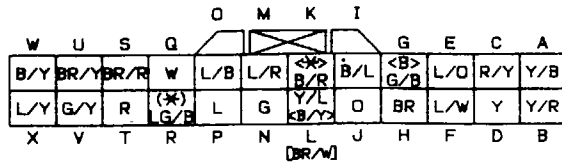

[]... WITH A. B. S.
()... LOW GRADE MODEL
<>... A/T

F-32 MAIN RELAY(F)

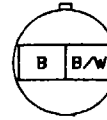

F-33 MAIN RELAY(F)



F-34 COIL WITH IGNITER(T)(F)



F-35 COIL WITH IGNITER(T)(F)

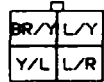

F-36 COIL WITH IGNITER(L)(F)

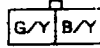

F-37 WATER TEMP. SWITCH(F)



F-38 HEAT HAZARD SWITCH(F)



F-39 CHECK CONNECTOR(F)



F-40 CHECK CONNECTOR(F)

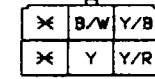

F-41 CHECK CONNECTOR(F)



F-43 CONDENSER(F)



F-48 POWER STEERING SWITCH(F)



E-07 NEUTRAL SWITCH(E) (FOR M/T)

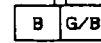

E-08 CRANK ANGLE SENSOR(E)



E-09 OVER TOP SWITCH(E)

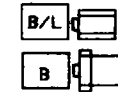

E-12 OVER DRIVE OIL PRESSURE SWITCH(E) (FOR A/T)

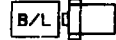

EM-03 EMISSION CONTROL UNIT(EM)

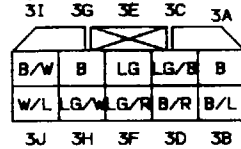

EM-04 INJECTOR(R. SECONDARY)(EM)



EM-05 INJECTOR(R. PRIMARY)(EM)



EM-06 INJECTOR(F. SECONDARY)(EM)



EM-07 INJECTOR(F. PRIMARY)(EM)



FE-02 CONNECTOR BETWEEN FRONT(F) AND ENGINE(E) HARNESS

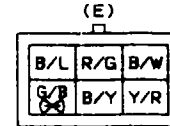
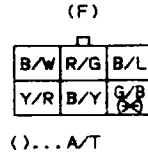

FE-03 CONNECTOR BETWEEN FRONT(F) AND ENGINE(E) HARNESS

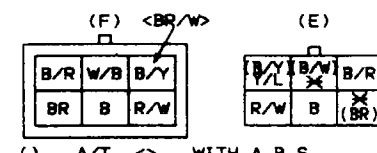

()... A/T <>... WITH A. B. S.

FE-04 CONNECTOR BETWEEN FRONT(F) AND ENGINE(E) HARNESS

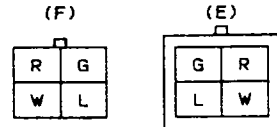

FE-05 CONNECTOR BETWEEN FRONT(F) AND ENGINE(E) HARNESS

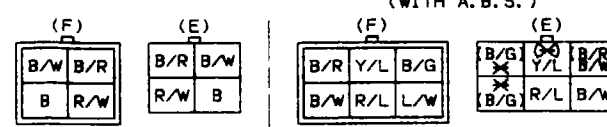

()... A/T

FEM-02 CONNECTOR BETWEEN FRONT(F) AND EMISSION(EM) HARNESS



()... A/T & WITH A. B. S.

50 WIRING DIAGRAM

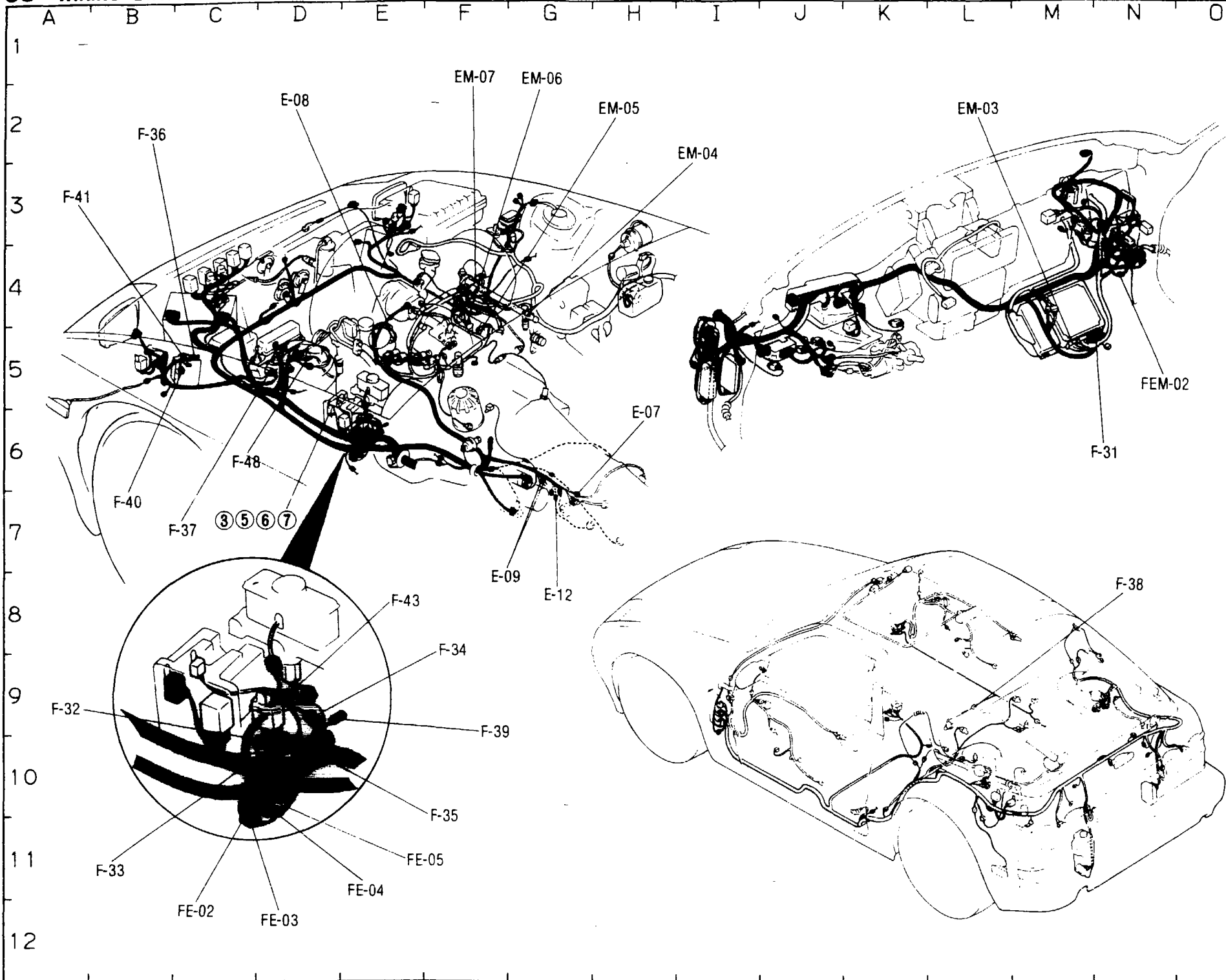

[NON TURBO] ■ E. G. I. & EMISSION CONTROL SYSTEM

A
2
1
S
B

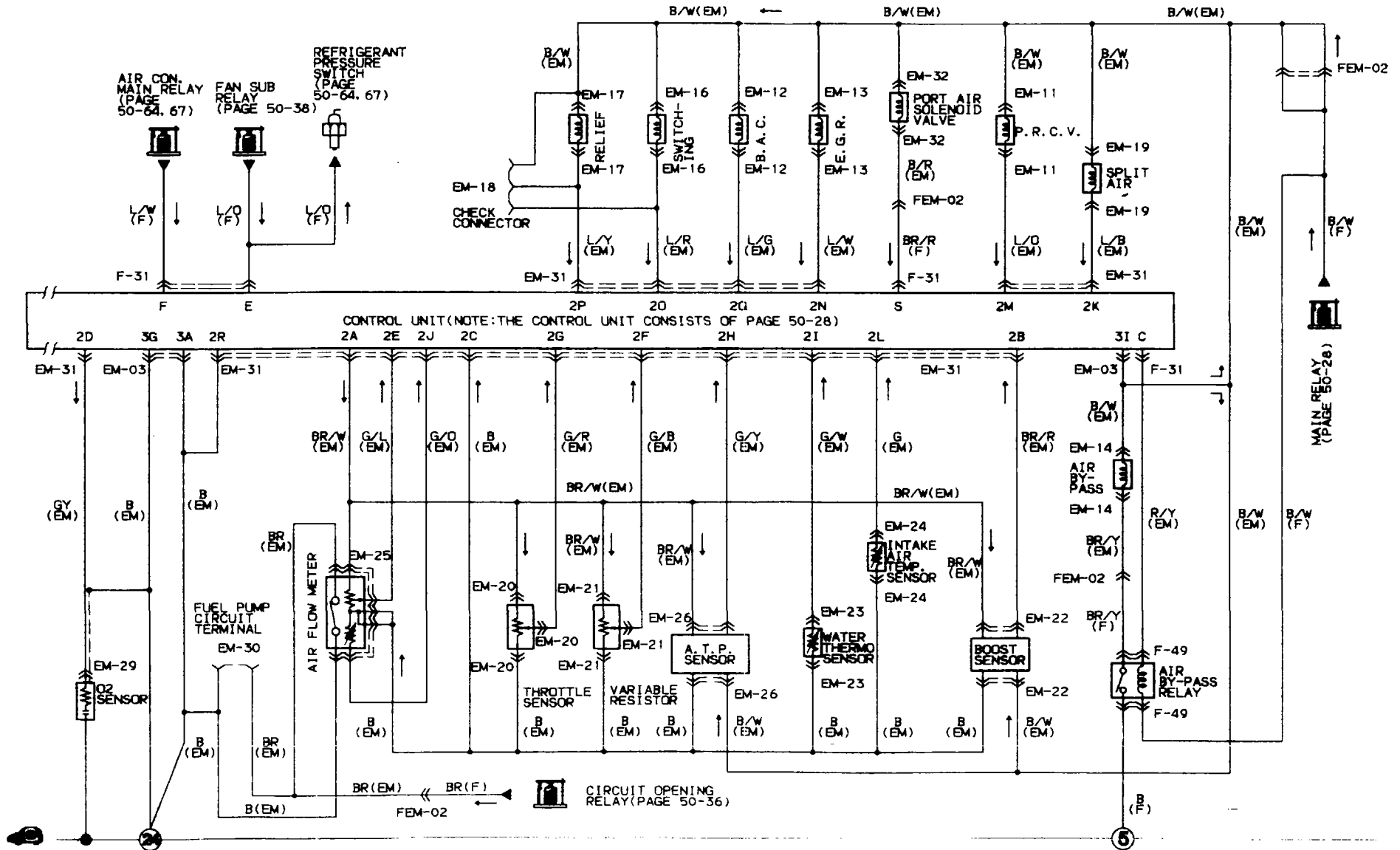

F-31 EMISSION CONTROL UNIT(F)

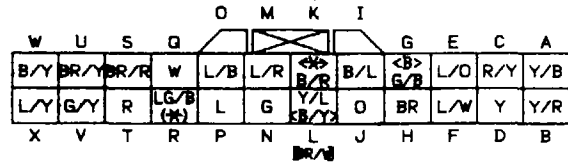

<...A/T
 (...LOW GRADE MODEL
 [...WITH A. B. S.

F-49 AIR BY-PASS RELAY(F)

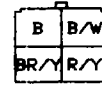

EM-03 EMISSION CONTROL UNIT (EM)

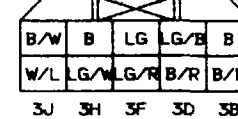

EM-11 PRESSURE REGULATOR CONTROL SOLENOID VALVE(EM) (P. R. C. V.)

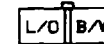

EM-12 BY-PASS AIR CONTROL VALVE(EM) (B. A. C.)

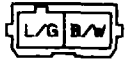

EM-13 E.G.R. SOLENOID VALVE(EM)



EM-14 AIR BY-PASS SOLENOID VALVE (EM)



EM-16 SWITCHING SOLENOID VALVE(EM)



EM-17 RELIEF SOLENOID VALVE(EM)

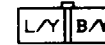

EM-18 CHECK CONNECTOR (EM)

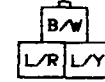

EM-19 SPLIT AIR SOLENOID VALVE(EM)



EM-20 THROTTLE SENSOR(EM)



EM-21 VARIABLE RESISTOR (EM)

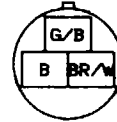

EM-22 BOOST SENSOR (EM)



EM-23 WATER THERMO. SENSOR(EM)



EM-24 INTAKE AIR TEMP. SENSOR(EM)



EM-25 AIR FLOW METER(EM)



EM-26 ATMOSPHERIC PRESSURE SENSOR (A. T. P.) (EM)

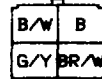

EM-29 O2 SENSOR(EM)



EM-30 FUEL PUMP CIRCUIT TERMINAL(EM)



EM-31 EMISSION CONTROL UNIT(EM)

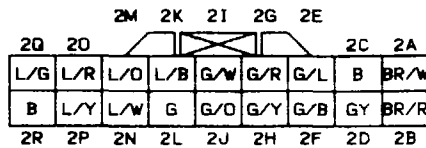

EM-32 PORT AIR SOLENOID VALVE(EM)



FEM-02 CONNECTOR BETWEEN FRONT(F) AND EMISSION(EM) HARNESS



(...A/T & WITH A. B. S.

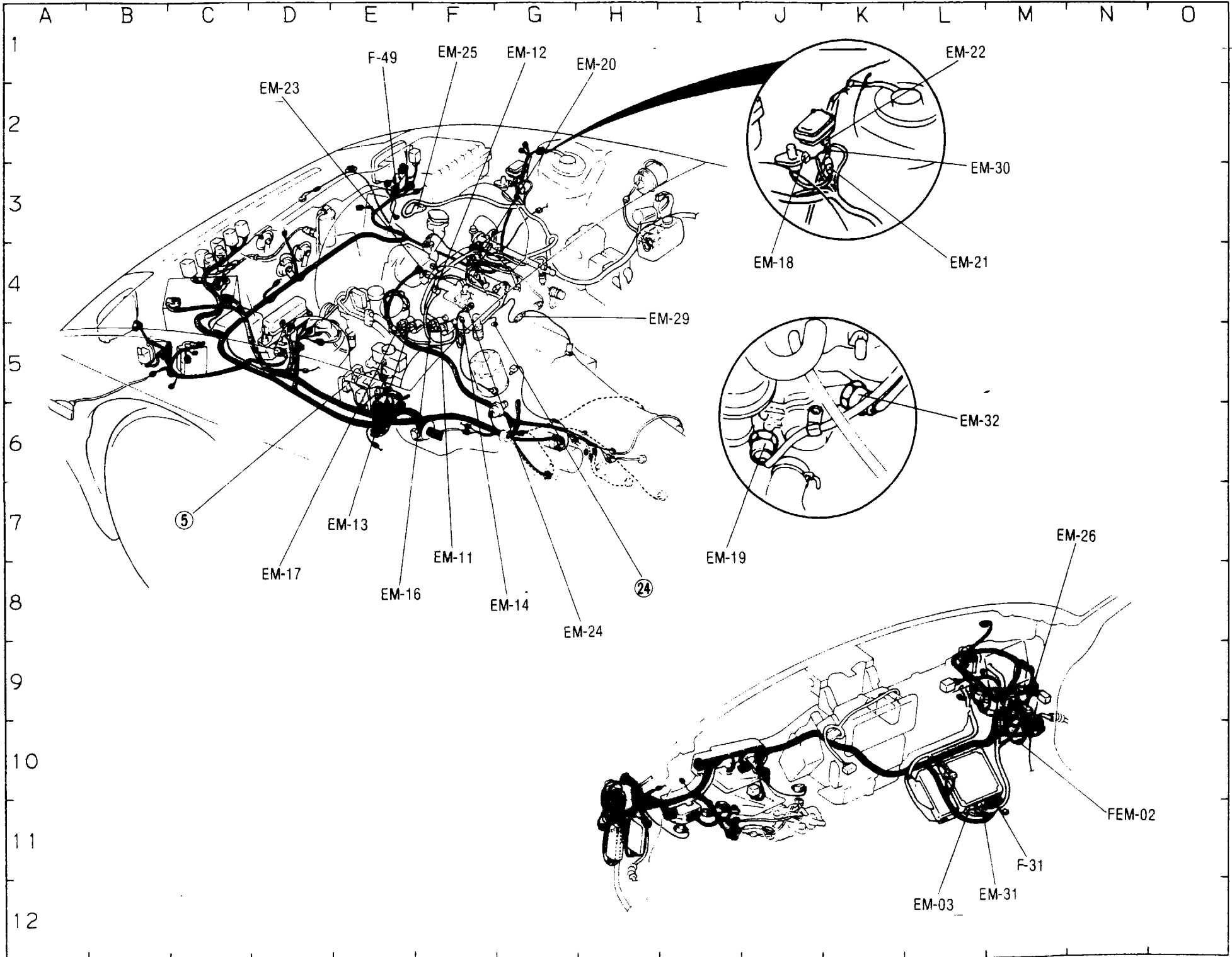

[TURBO] ■ FUEL PUMP & SUB-ZERO STARTING ASSIST SYSTEM

A
2
1
S
B

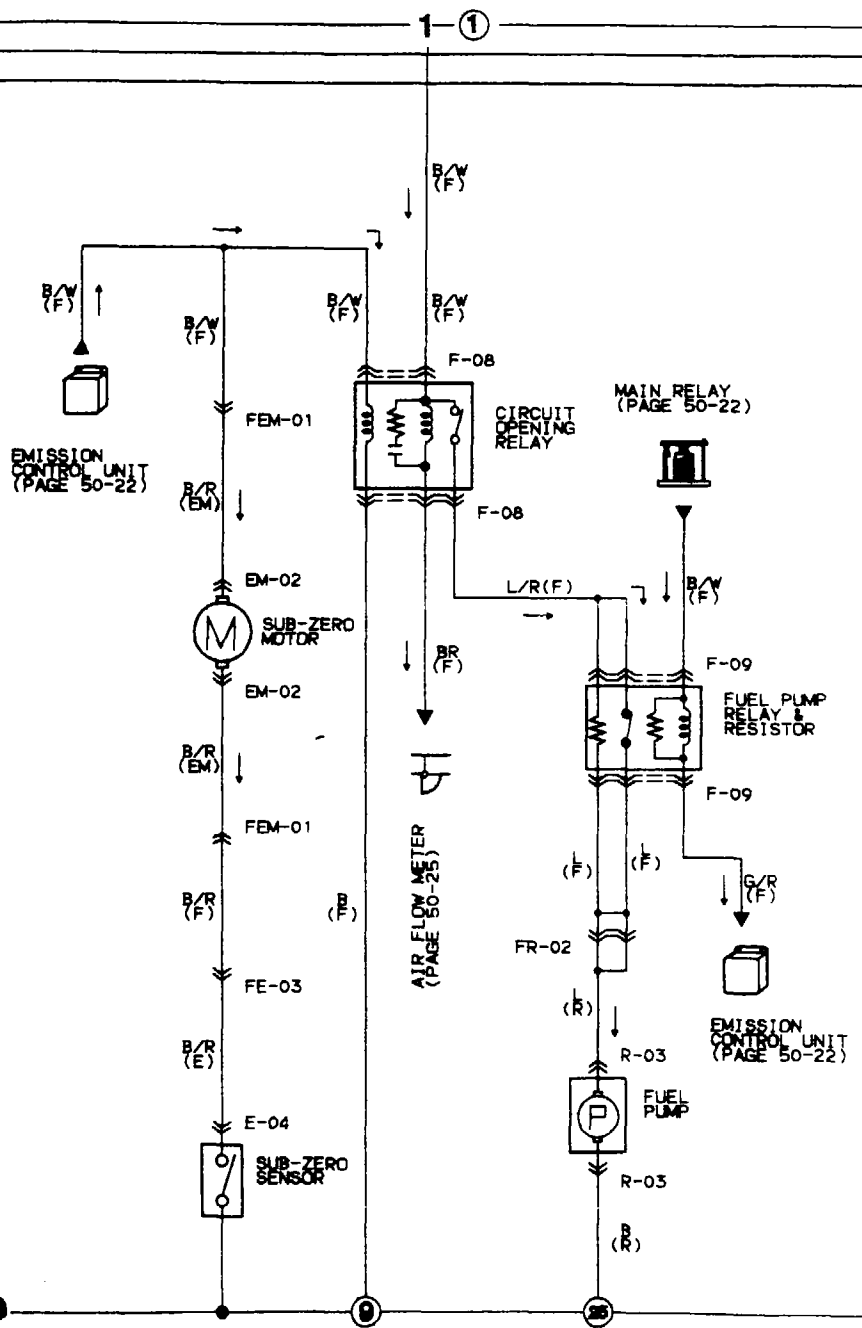

F-08 CIRCUIT OPENING RELAY(F)

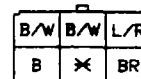

F-09 FUEL PUMP RELAY & RESISTOR(F)

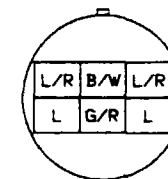

E-04 SUB-ZERO SENSOR(E)



R-03 FUEL PUMP(R)



EM-02 SUB-ZERO MOTOR(EM)



FE-03 CONNECTOR BETWEEN FRONT(F) AND ENGINE(E) HARNESS

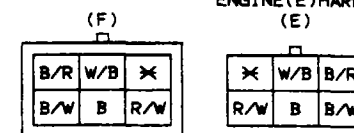

FR-02 CONNECTOR BETWEEN FRONT(F) AND REAR(R) HARNESS

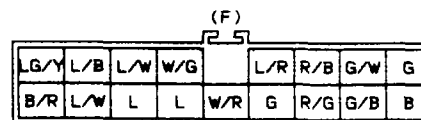

(R)



FEM-01 CONNECTOR BETWEEN FRONT(F) AND EMISSION(EM) HARNESS

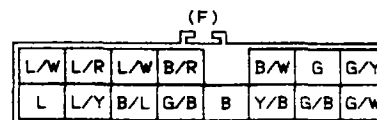

(EM)



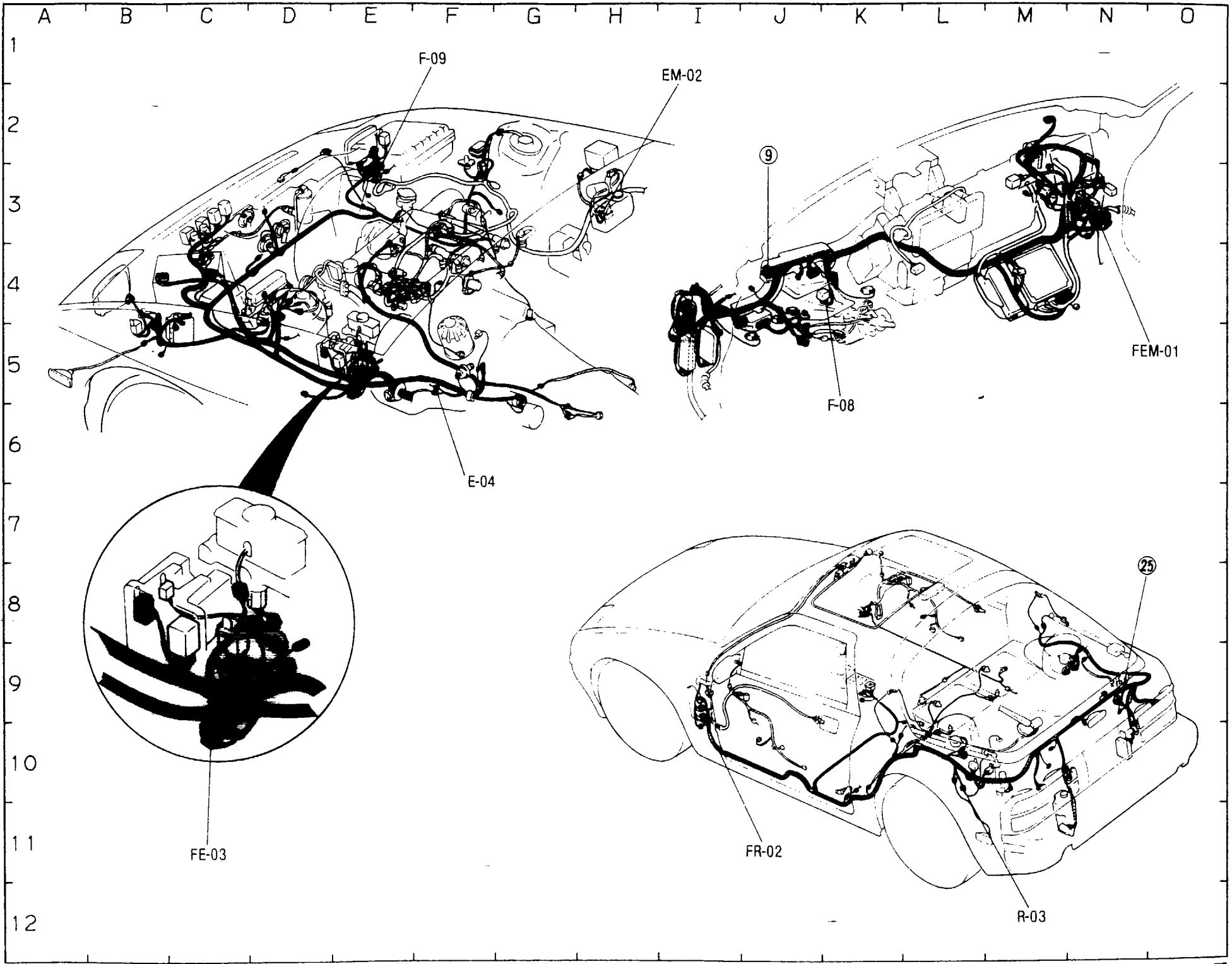

[NON TURBO] ■ FUEL PUMP & SUB-ZERO STARTING ASSIST SYSTEM

A
2
1
S
B

NOTE: (...)... A/T OR WITH A. B. S.

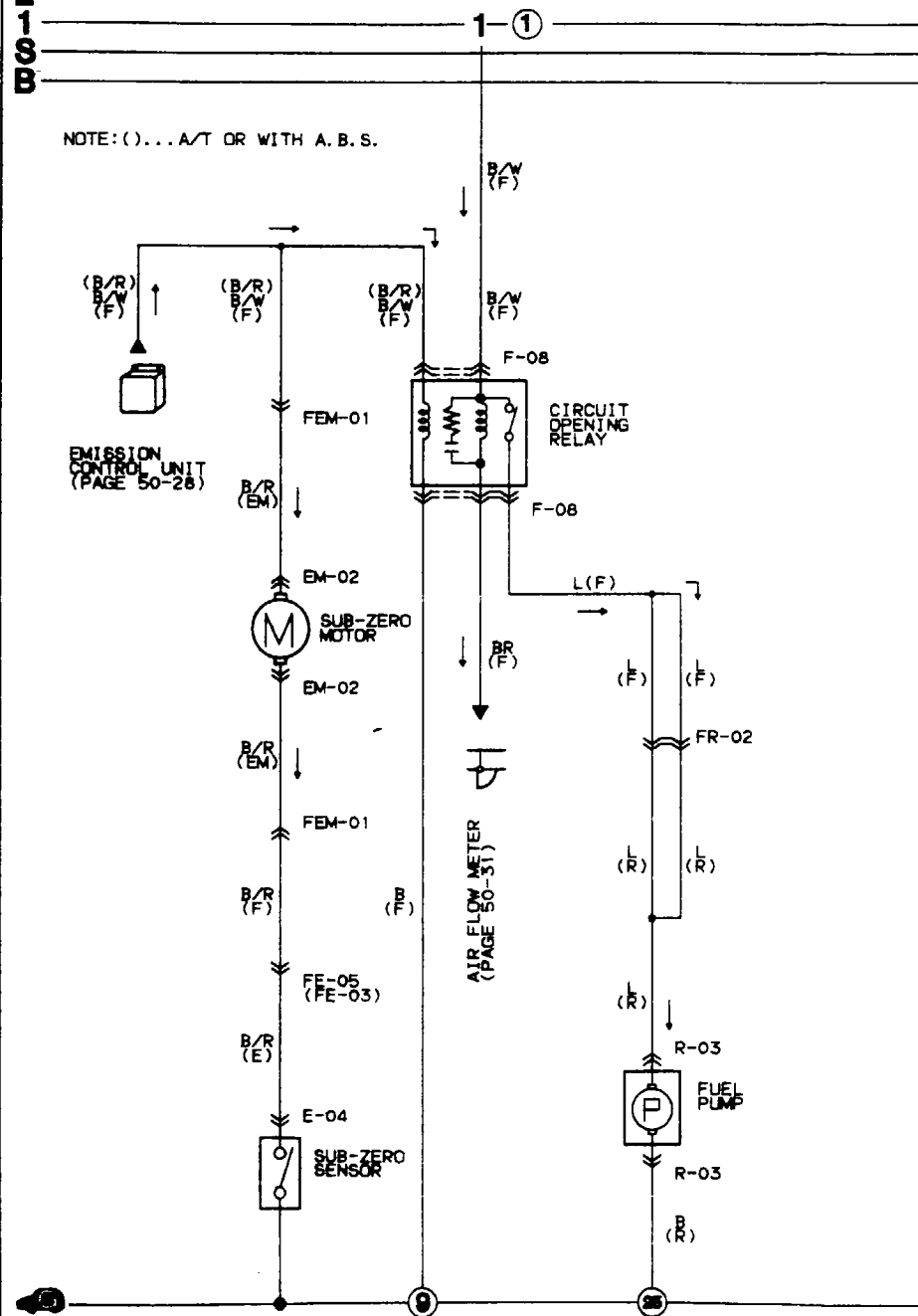

F-08 CIRCUIT OPENING RELAY(F)

(B/R)	(B/W)	(L/R)
(B/W)	(B)	(BR)

(...)... A/T OR WITH A. B. S.

E-04 SUB-ZERO SENSOR(E)



R-03 FUEL PUMP(R)

(L)	(B)
(W/R)	(W/G)

EM-02 SUB-ZERO MOTOR(EM)



FE-03 CONNECTOR BETWEEN FRONT(F) AND ENGINE(E) HARNESS

(F)	(E)
(B/R)	(B/W)
(BR)	(B)

FE-05 CONNECTOR BETWEEN FRONT(F) AND ENGINE(E) HARNESS

(F)	(E)
(B/W)	(B/R)
(R/W)	(B)

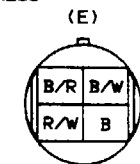
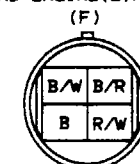

(...)... WITH A. B. S. <>... A/T

FR-02 CONNECTOR BETWEEN FRONT(F) AND REAR(R) HARNESS

(F)	(R)
(*)	(*)
(L/W)	(W/G)
(L/R)	(R/B)
(G/W)	(G)
(B/R)	(B)
(*)	(*)
(L/W)	(L)
(L)	(L)
(W/R)	(G)
(R/G)	(G/B)
(*)	(*)

(...)... LOW GRADE MODEL <>... CONVERTIBLE MODEL

FEM-01 CONNECTOR BETWEEN FRONT(F) AND EMISSION(EM) HARNESS

(F)	(EM)
(L/W)	(L/R)
(B/W)	(B/R)
(*)	(*)
(L)	(L)
(L/Y)	(W/B)
(*)	(*)
(B)	(B)
(*)	(*)
(G/B)	(G/W)

(...)... A/T OR WITH A. B. S.

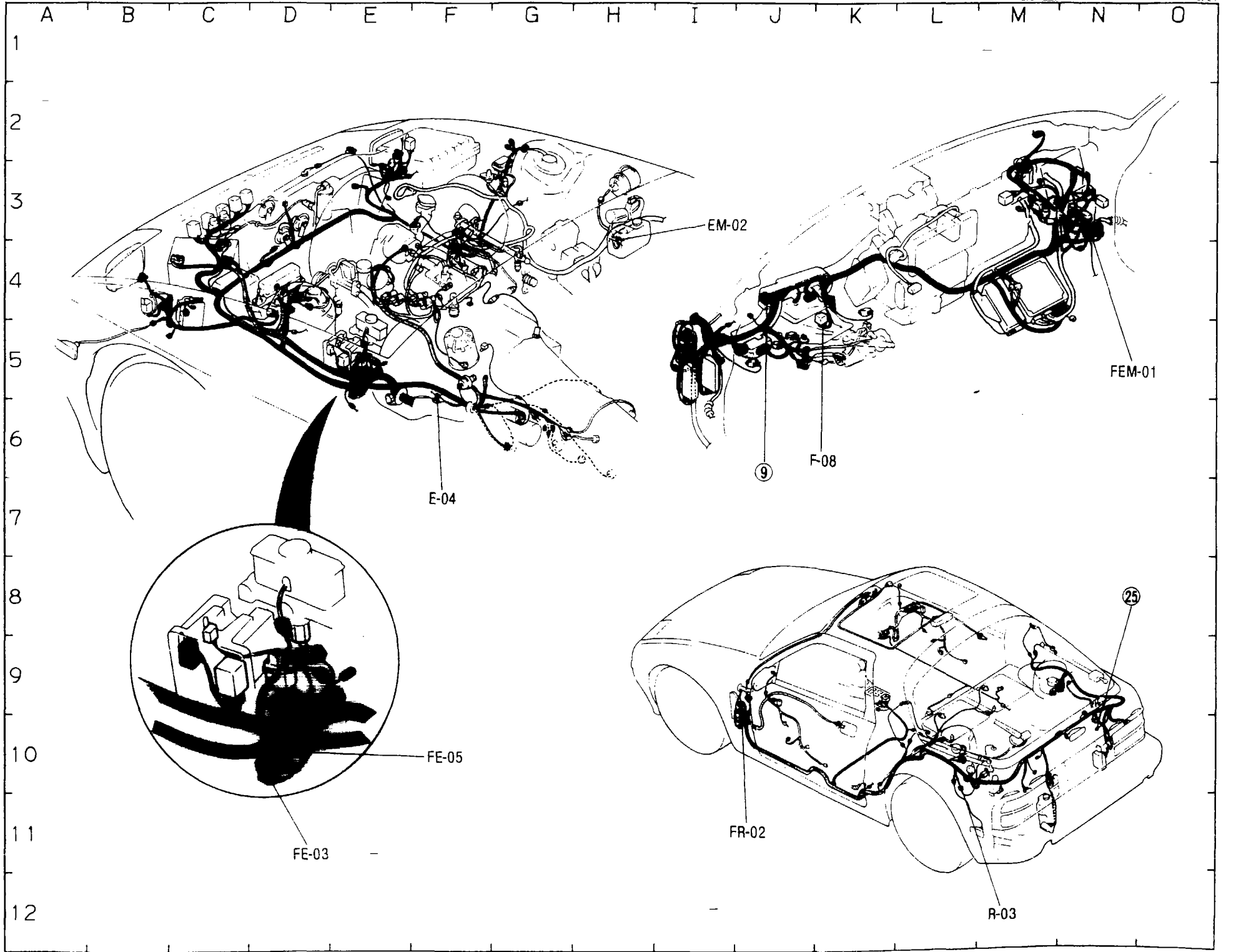

[EXCEPT NON TURBO M/T] ■ COOLING FAN SYSTEM

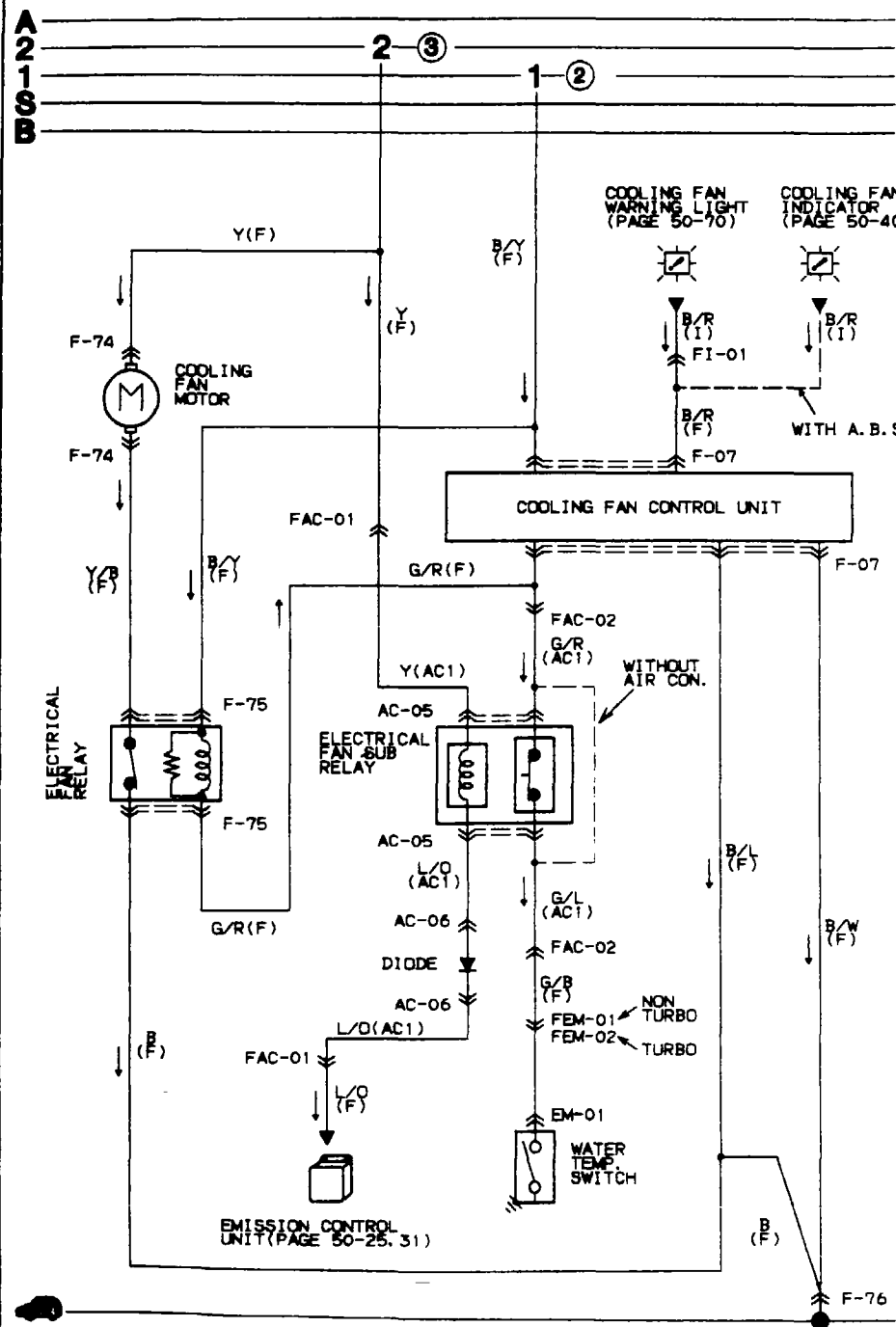

F-74 COOLING FAN MOTOR(F)

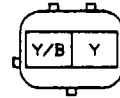

F-75 ELECTRICAL FAN RELAY(F)

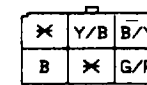

F-76 GROUND(F)

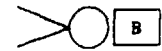

F-07 COOLING FAN CONTROL UNIT(F)

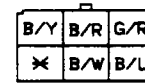

EM-01 WATER TEMP SWITCH(EM)

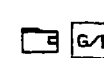

AC-05 ELECTRICAL FAN SUB RELAY(AC)

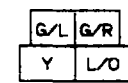

AC-06 DIODE(AC)



FAC-01 CONNECTOR BETWEEN FRONT(F) AND AIR CON.(AC1) HARNESS

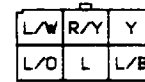

FAC-02 CONNECTOR BETWEEN FRONT(F) AND AIR CON.(AC1) HARNESS

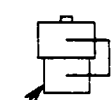
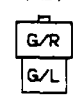
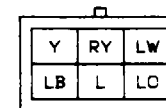

WITHOUT AIR CON.

FI-01 CONNECTOR BETWEEN FRONT(F) AND INSTRUMENT PANEL(I) HARNESS

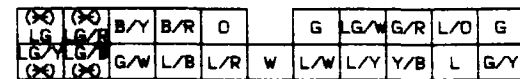
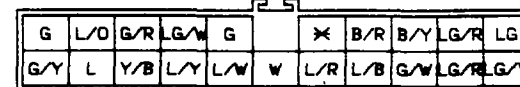

FEM-01 CONNECTOR BETWEEN FRONT(F) AND EMISSION(EM) HARNESS

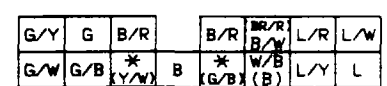
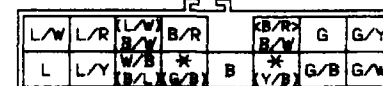

()...TURBO <-...A/T OR WITH A.B.S.

FEM-02 CONNECTOR BETWEEN FRONT(F) AND EMISSION(EM) HARNESS

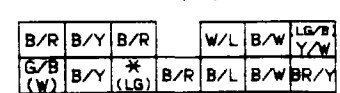
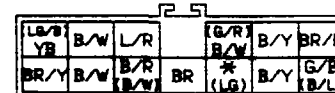

()...TURBO

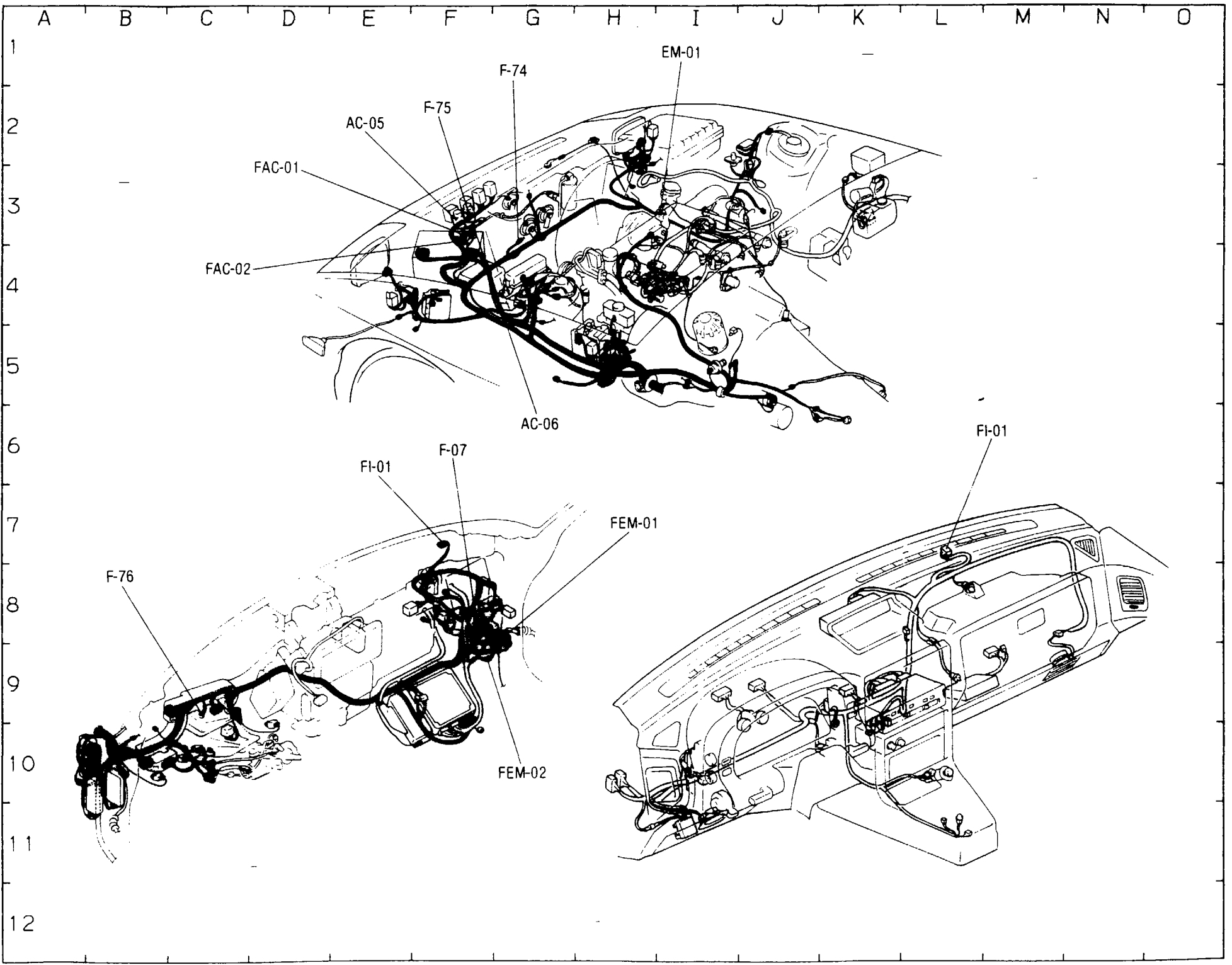

METERS & WARNING SYSTEM

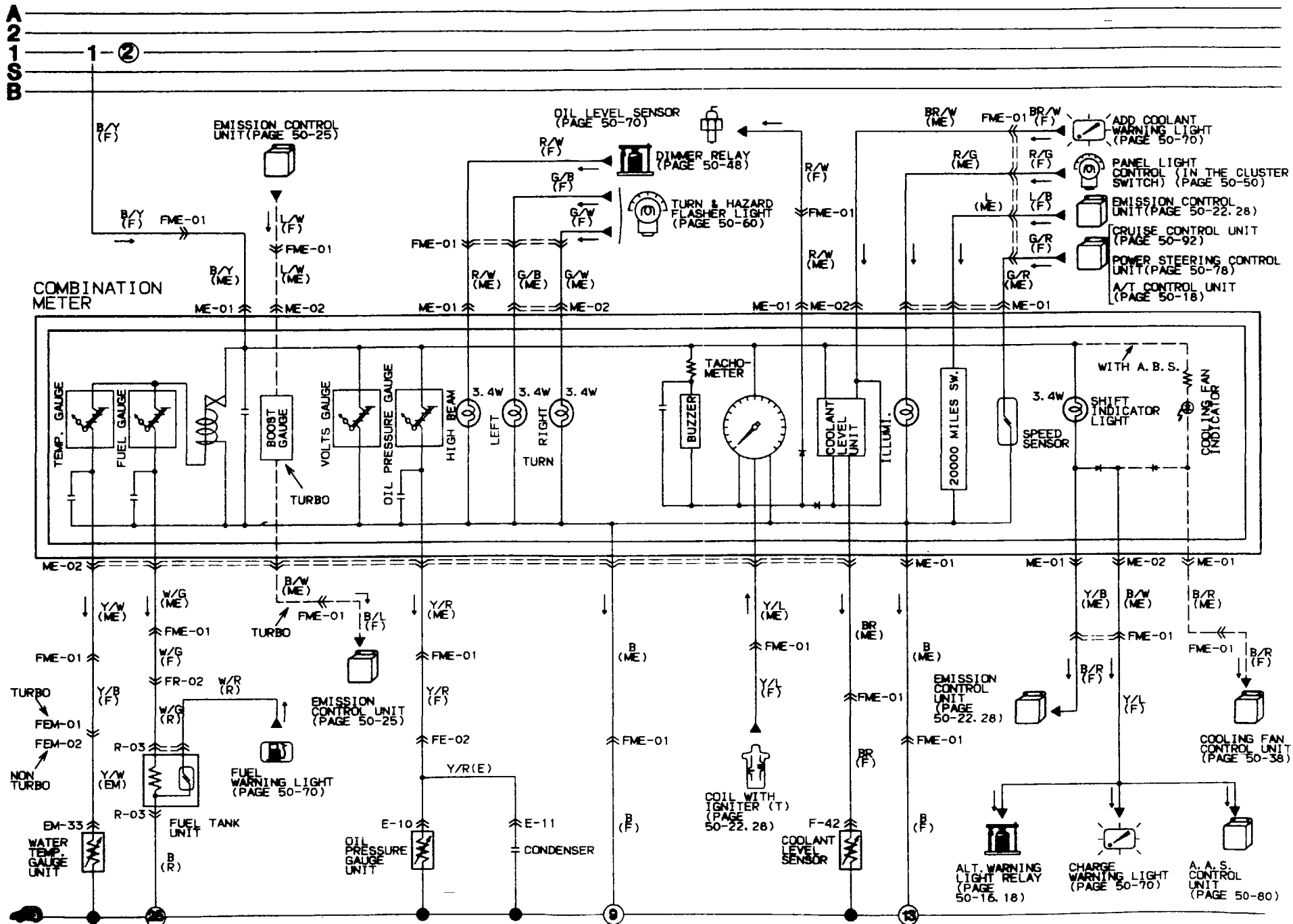

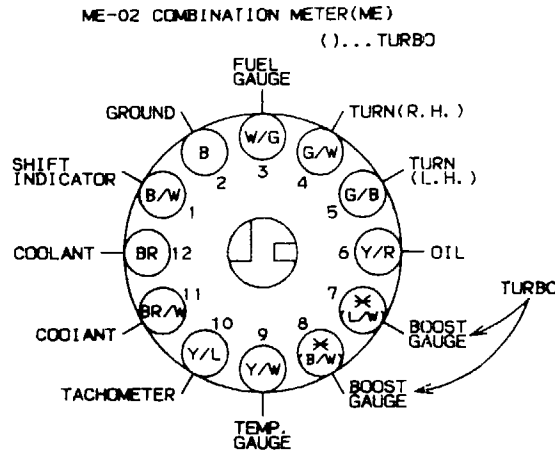
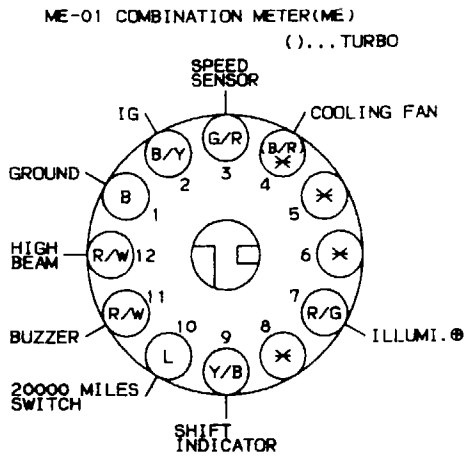

FEM-01 CONNECTOR BETWEEN FRONT(F) AND METER(ME) HARNESS

(F)											
G/R	G/W	Y/L	R/W	W/G		Y/R	BR	B	(*)	(*)	(*)
L/B	B	G/B	Y/B	R/G	R/W	BR/W	B/Y	(*)	(*)	(*)	(*)

(ME)											
(*)	(*)	B/W	B	BR	Y/R		W/G	R/W	Y/L	G/W	G/R
(*)	(*)	(*)	Y/B	B/Y	BR/W	R/W	R/G	Y/W	G/B	B	L

()...A/T <>...TURBO []...WITH A.B.S.

F-42 COOLANT LEVEL SENSOR(F)



E-10 OIL PRESSURE GAUGE UNIT(E)



E-11 CONDENSER(E)



R-03 FUEL TANK UNIT(R)



EM-33 WATER TEMP. GAUGE UNIT(EM)



FE-02 CONNECTOR BETWEEN FRONT(F) AND ENGINE(E) HARNESS

(F)				(E)			
B/W	R/G	B/L		B/L	R/G	B/W	
Y/R	B/Y	G/B (*)		G/B (*)	B/Y	Y/R	

()...A/T

FR-02 CONNECTOR BETWEEN FRONT(F) AND REAR(R) HARNESS

(F)												(R)											
(*)	(*)	L/W	W/G		L/R	R/B	G/W	G				G	G/W	R/B	L/R		W/G	L/W	(*)	(*)			
(*)	(*)	L/W	L	L	W/R	G	R/G	G/B	B	(*)	(*)	B	G/B	R/G	G	W/R	L	L	L/W	B/R	(*)	(*)	

<>...LOW GRADE MODEL <>...CONVERTIBLE MODEL

FEM-01 CONNECTOR BETWEEN FRONT(F) AND EMISSION(EM) HARNESS

(F)												(EM)											
L/W	L/R	(L/W)	B/R		(G/R)	G	G/Y					G/Y	G	B/R		BR	BR/R	L/R	L/W				
L	L/Y	(L/W)	(B/L)	(G/B)	B	(Y/B)	G/B	G/W				G/W	G/B	(Y/W)	B	(G/B)	W/B (B)	L/Y	L				

()...TURBO <>...NON TURBO WITH A/T OR A.B.S.

FEM-02 CONNECTOR BETWEEN FRONT(F) AND EMISSION(EM) HARNESS

(F)												(EM)											
(G/B)	B/W	L/R		(G/R)	B/Y	BR/R						B/R	B/Y	B/R		W/L	B/W	(G/B)	(*)	(*)			
BR/Y	B/W	(B/W)	BR	(LG)	B/Y	(B/L)						(W)	B/Y	(LG)	BR	B/L	B/W	BR/Y					

()...TURBO <>...NON TURBO M/T []...CONVERTIBLE MODEL

50 WIRING DIAGRAM

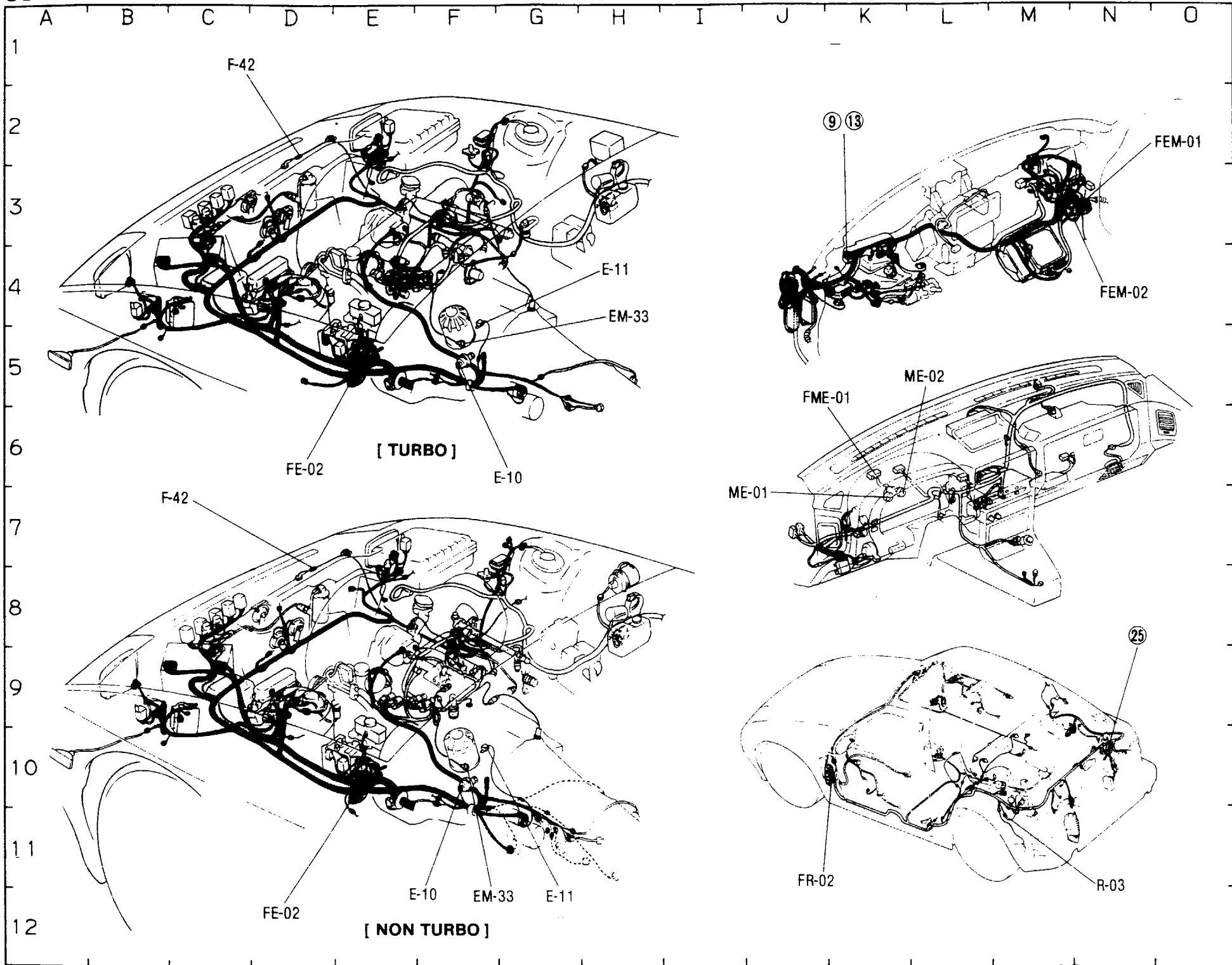

FRONT WIPER & WASHER

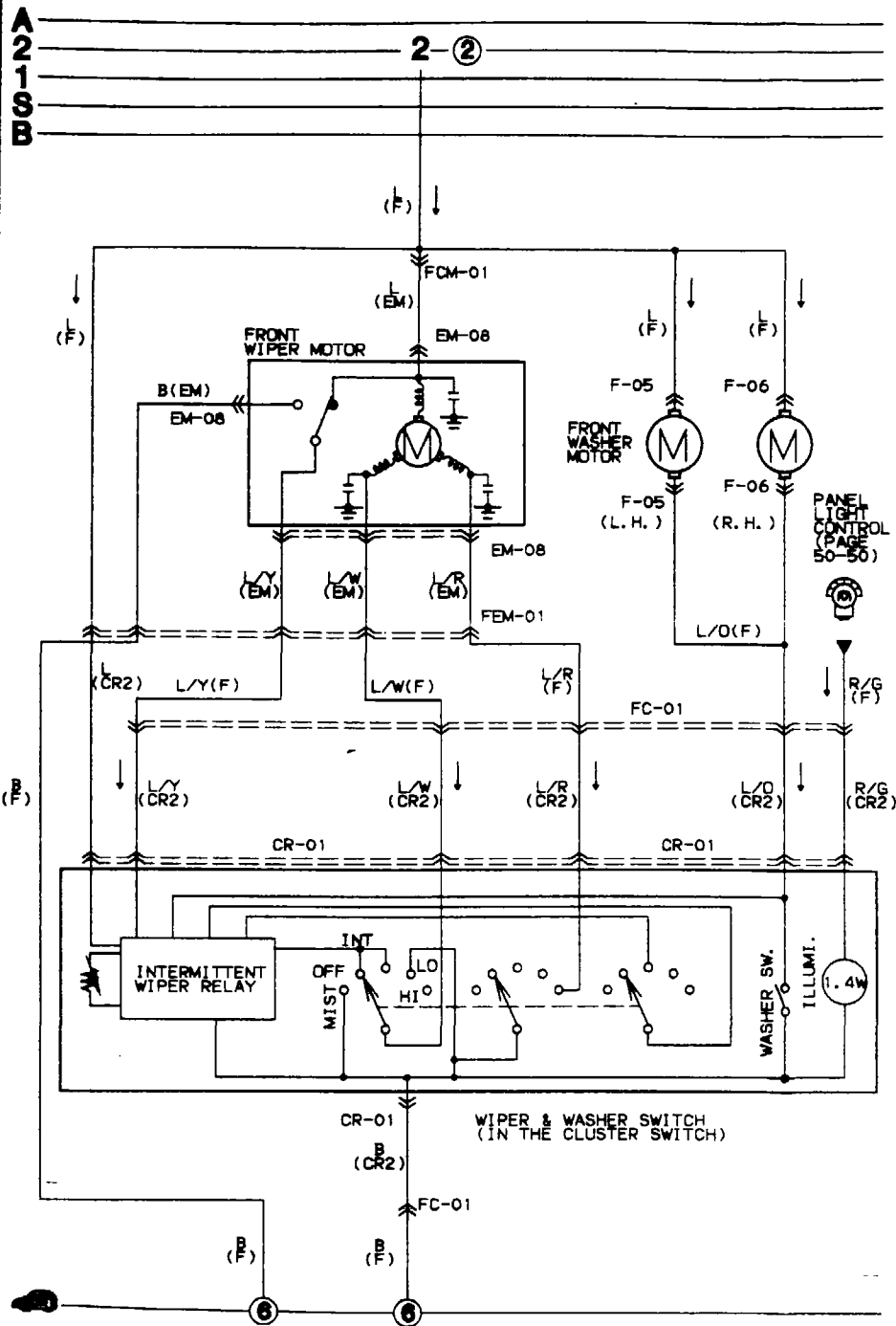

F-05 FRONT WASHER MOTOR (F)
(L.H.)

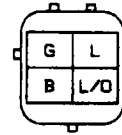

F-06 FRONT WASHER MOTOR (F)
(R.H.)

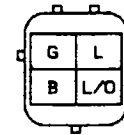

EM-08 FRONT WIPER MOTOR (EM)

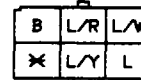

CR-01 WIPER & WASHER SWITCH (CR2)
(IN THE CLUSTER SWITCH)

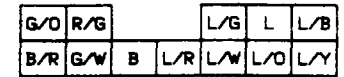

FEM-01 CONNECTOR BETWEEN FRONT (F) AND EMISSION (EM) HARNESS

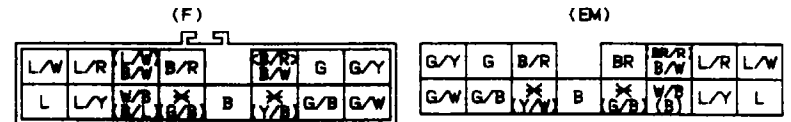

()...TURBO <>...E.G.I. WITH A/T OR A.B.S.

FC-01 CONNECTOR BETWEEN FRONT (F) AND CLUSTER SWITCH (CR2) HARNESS

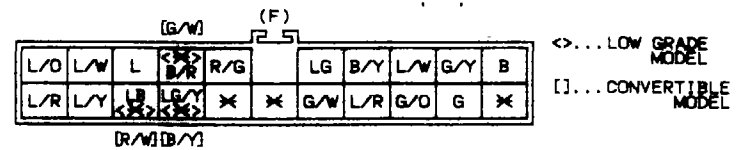

<>... LOW GRADE MODEL
[]... CONVERTIBLE MODEL

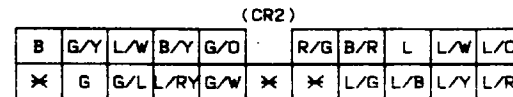

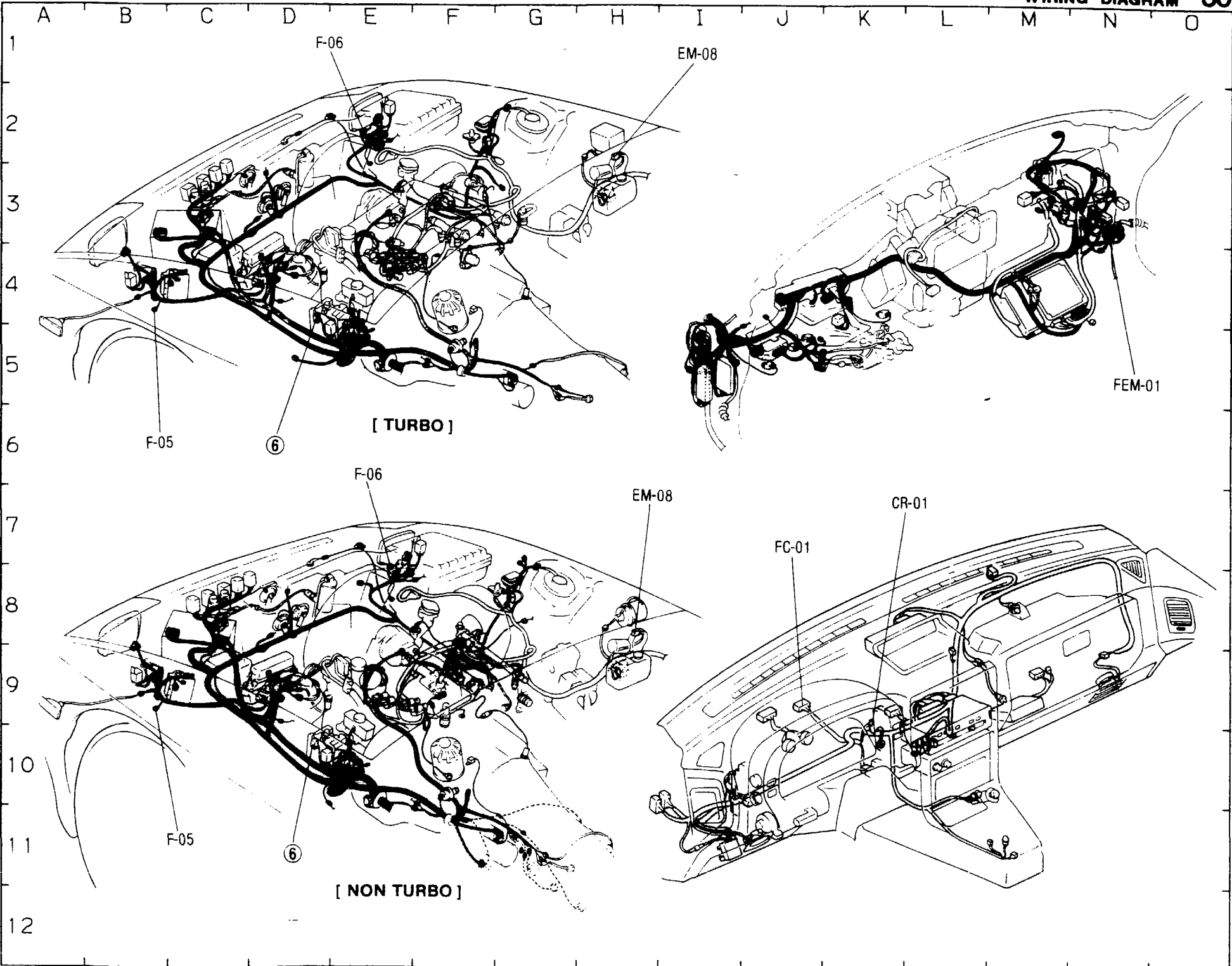

EXCEPT CONVERTIBLE MODEL & LOW GRADE MODEL = REAR WIPER & WASHER

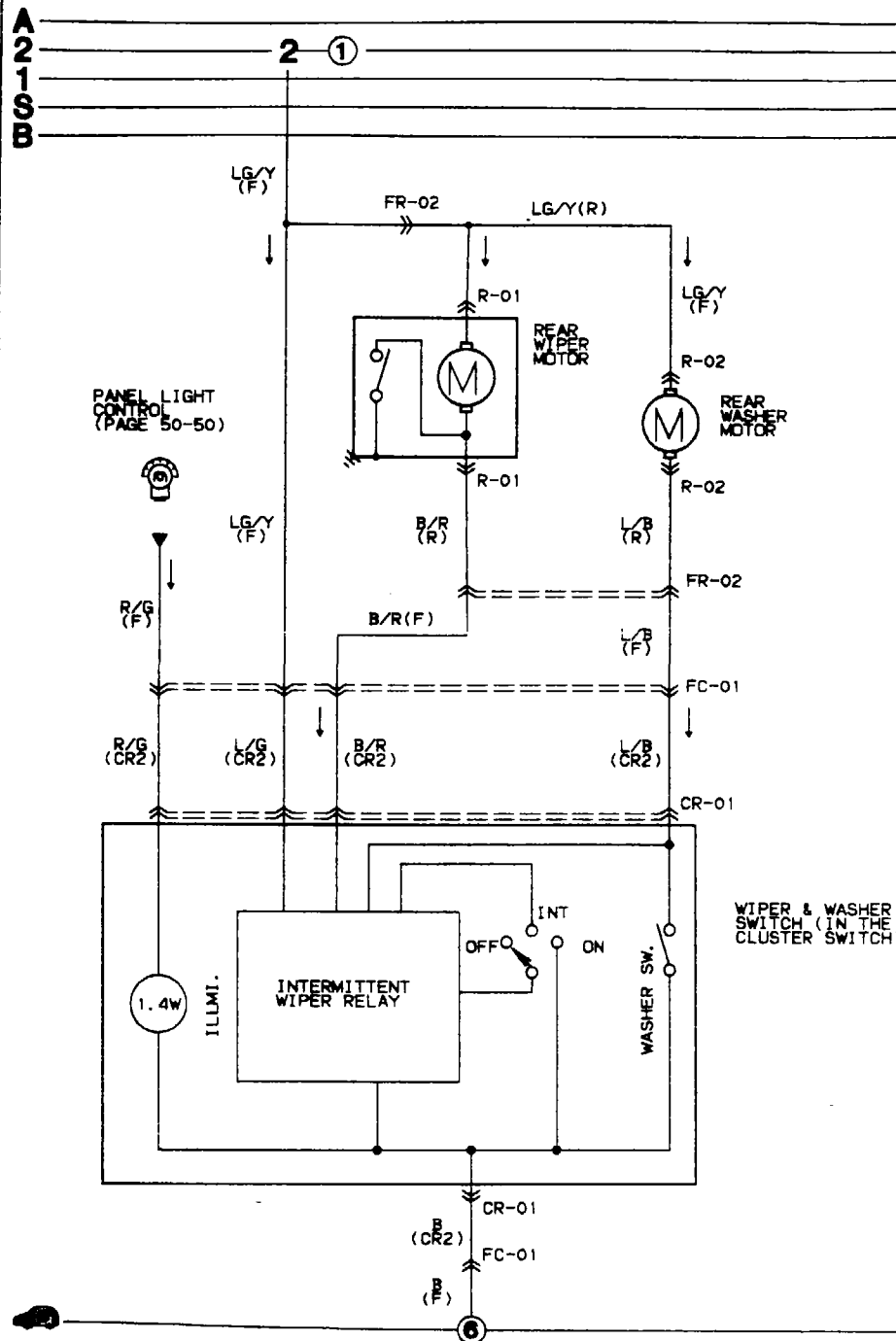

R-01 REAR WIPER MOTOR (R)



R-02 REAR WASHER MOTOR (R)



CR-01 WIPER & WASHER SWITCH (CR2) (IN THE CLUSTER SWITCH)

G/O	R/G			L/G	L	L/B
B/R	G/W	B	L/R	L/W	L/O	L/Y

FR-02 CONNECTOR BETWEEN FRONT (F) AND REAR (R) HARNESS

(F)						
LG/Y	L/B	L/W	W/G		L/R	R/B
B/R	L/W	L	L	W/R	G	R/G

(R)						
G	G/W	R/B	L/R		W/G	L/W
B	G/B	R/G	G	W/R	L	L

FC-01 CONNECTOR BETWEEN FRONT (F) AND CLUSTER SWITCH (CR2) HARNESS (R. H.)

(F)						
L/O	L/W	L	B/R	R/G		LG
L/R	L/Y	LB	LG/Y	* * *	G/W	L/R

(CR2)						
B	G/Y	L/W	B/Y	G/O		R/G
* * *	G	G/L	L/R	G/W	* * *	L/G

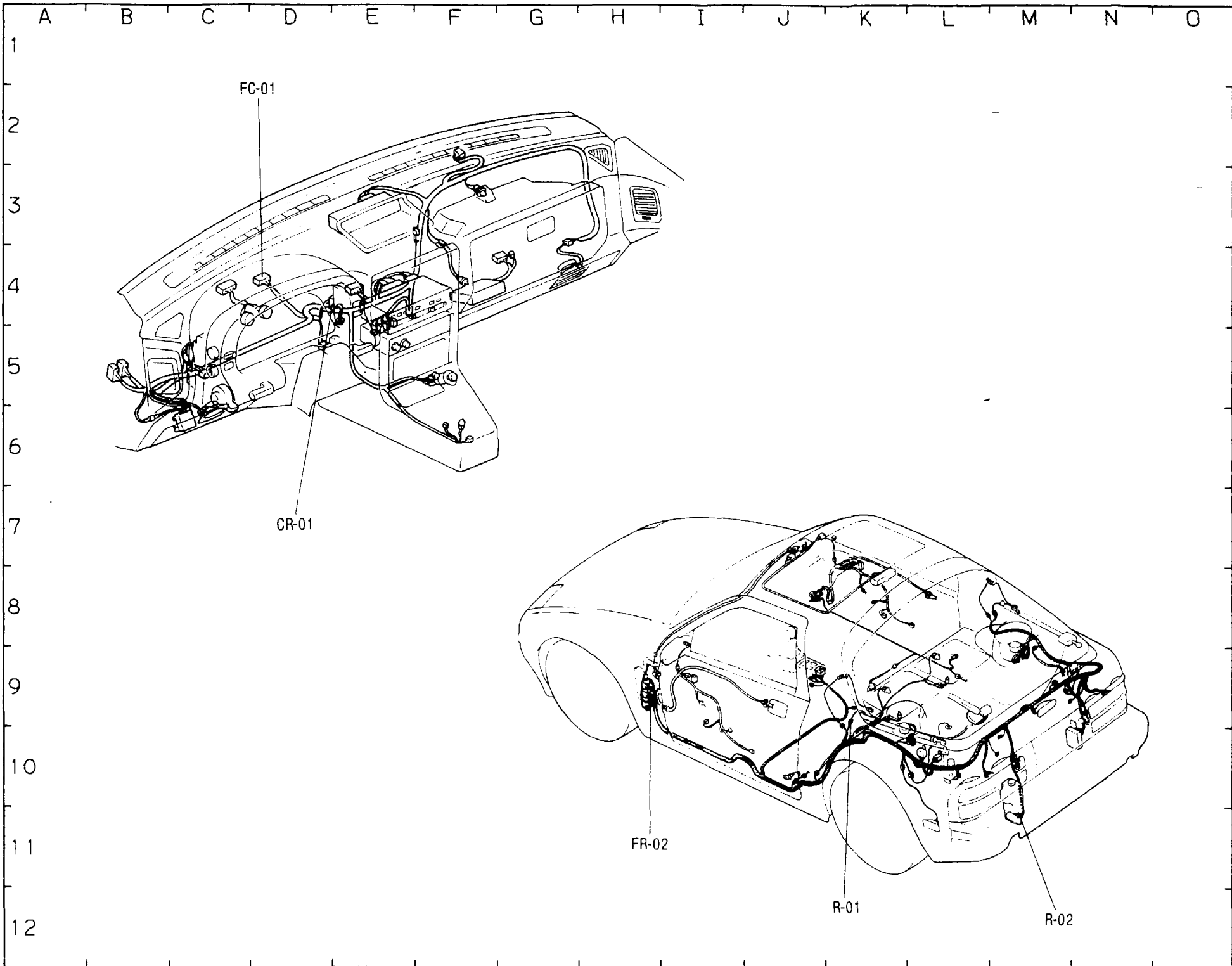

HEADLIGHTS

A
2
1
S
B

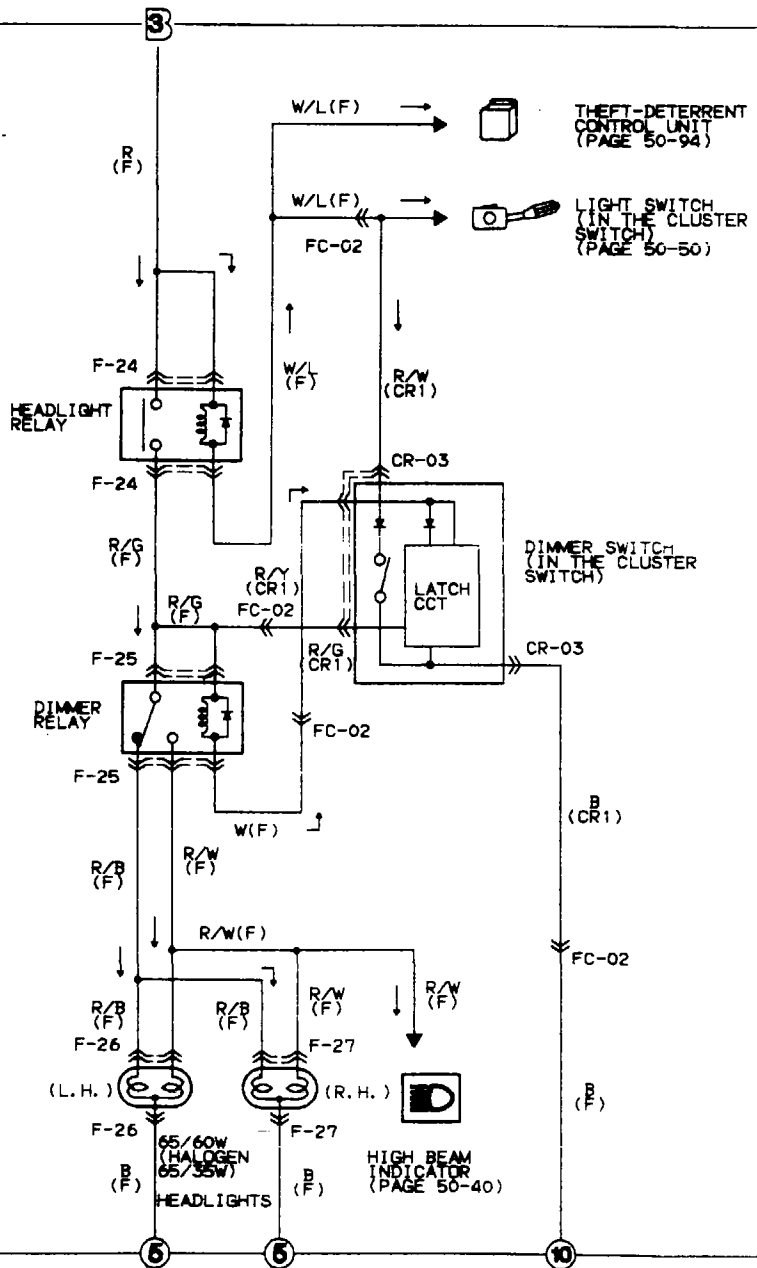

F-24 HEADLIGHT RELAY(F)

R	R
R/G	W/L

F-25 DIMMER RELAY(F)

R/W	R/G	R/G
R/B	X	W

F-26 HEADLIGHT(F)
(L.H.)

	R/B	
B		R/W

F-27 HEADLIGHT(F)
(R.H.)

	R/B	
B		R/W

CR-03 DIMMER SWITCH(CR1) (IN THE CLUSTER SWITCH)

R/G	R/W		B/R	G/W	
R/Y	R/G	G/R	G/Y	B	X

FC-02 CONNECTOR BETWEEN FRONT(F) AND CLUSTER SWITCH(CR1) HARNESS(L.H.)

						(F)				(CR1)					
G/B	G/R	R/B	R/L			W/G	W/L	R/G	X						
B	G/Y	R/G	L/O	R/Y	R	BR	W	B/L							

						(F)				(CR1)					
B/G	R/G	R/W	W/G			R/L	R/B	G/R	G/W						
B/L	R/Y	B/R	R	R/Y	L/O	R/G	G/Y	B							

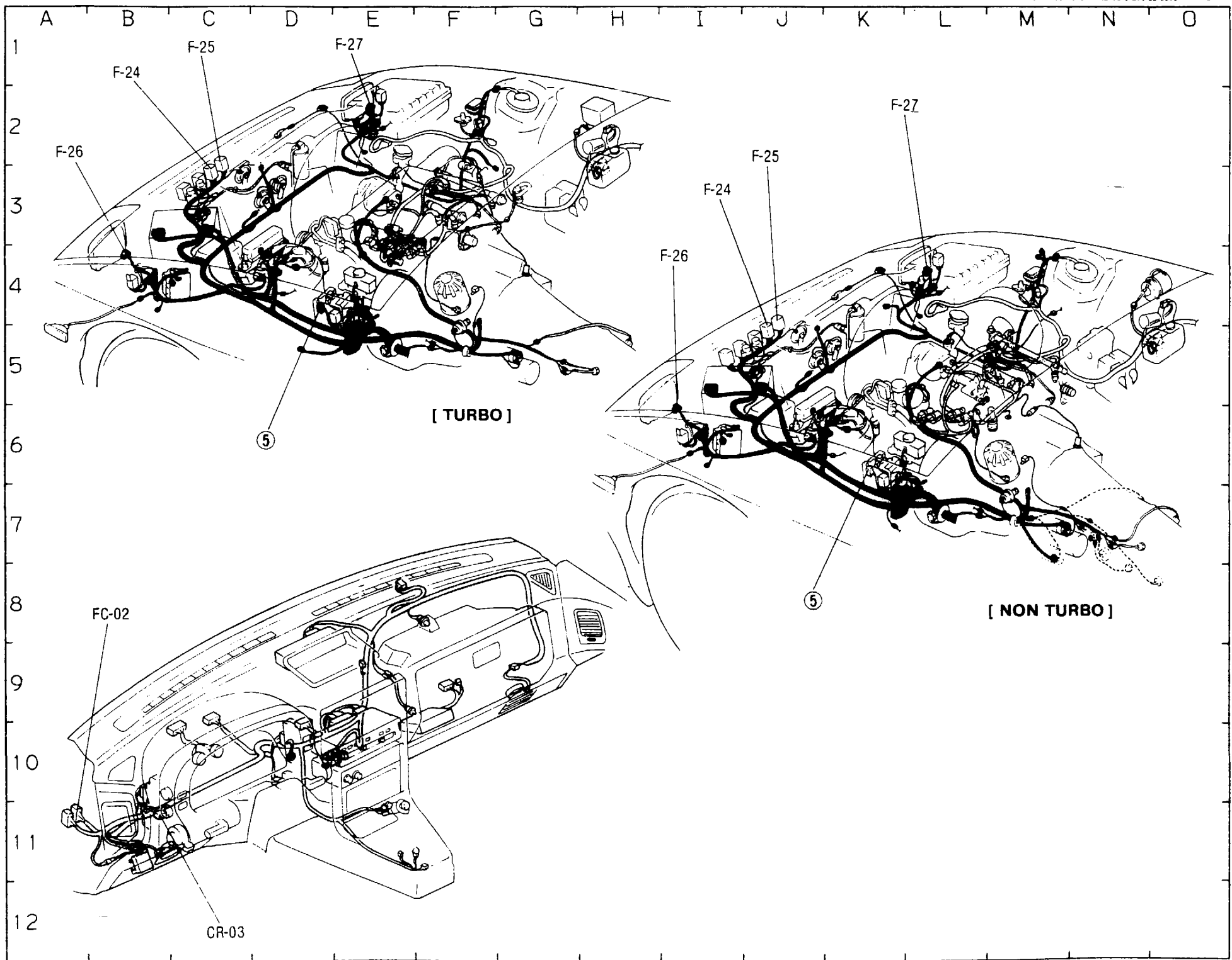

▪ RETRACTABLE HEADLIGHT ▪ HEADLIGHT CLEANER ▪ ILLUMINATION LIGHTS

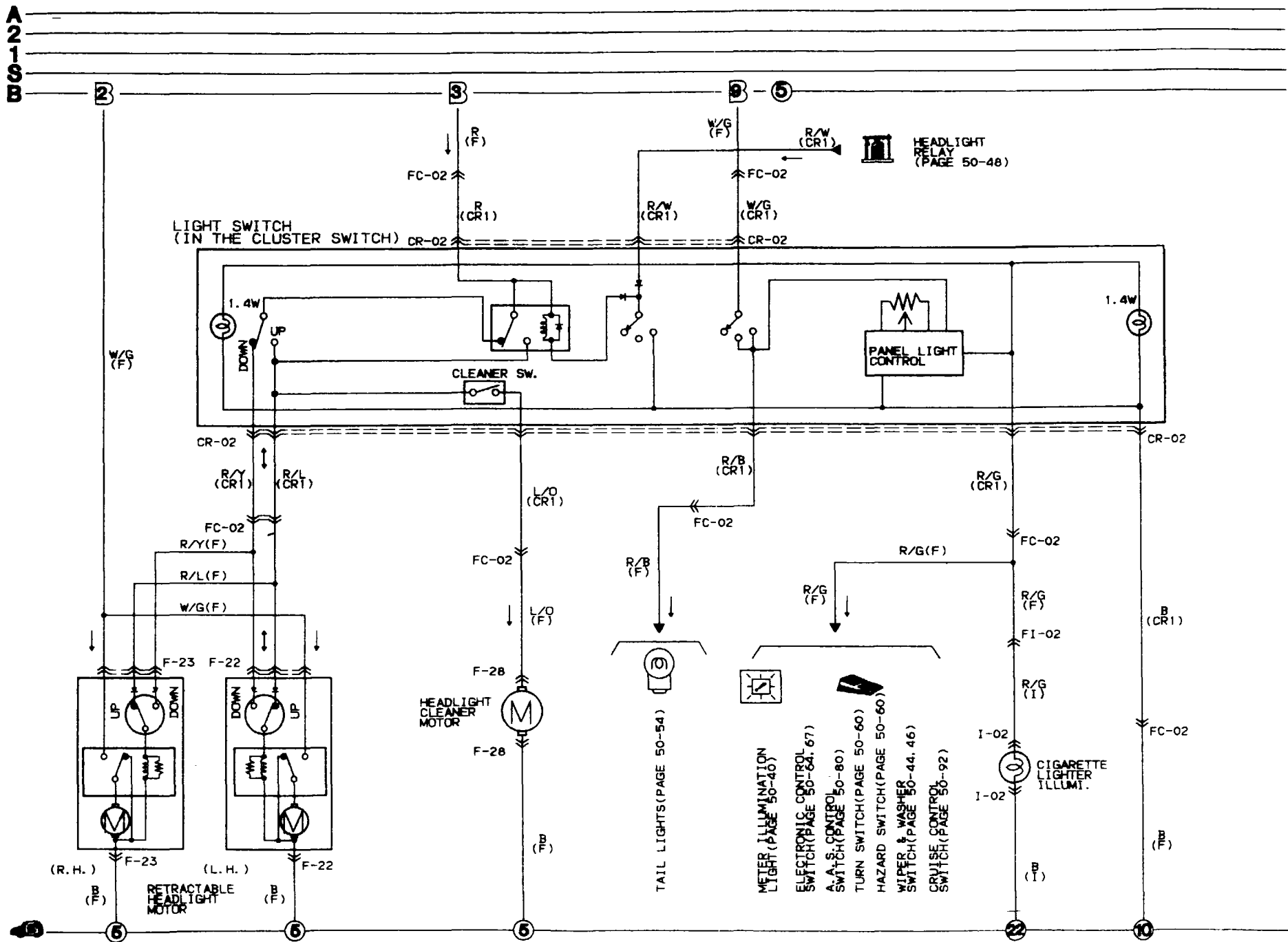

F-22 RETRACTABLE HEADLIGHT MOTOR(F)(L.H.)

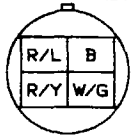

F-23 RETRACTABLE HEADLIGHT MOTOR(F)(R.H.)

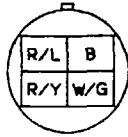

F-28 HEADLIGHT CLEANER MOTOR(F)

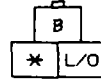

I-02 CIGARETTE LIGHTER ILLUMINATION LIGHT(I)



CR-02 LIGHT SWITCH(CR1)(IN THE CLUSTER SWITCH)



FC-02 CONNECTOR BETWEEN FRONT(F) AND CLUSTER SWITCH(CR1) HARNESS(L.H.)

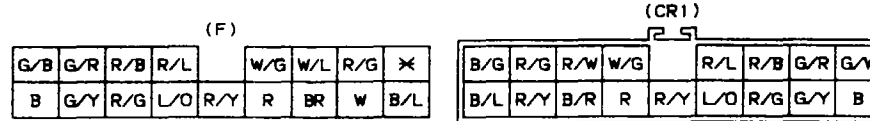

F1-02 CONNECTOR BETWEEN FRONT(F) AND INSTRUMENT PANEL(I) HARNESS

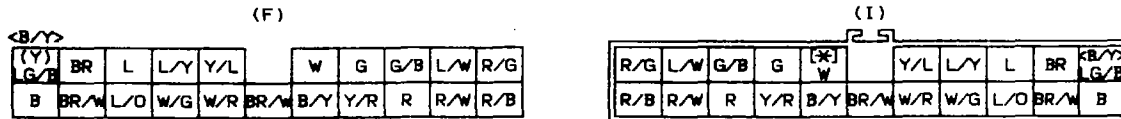

()...NON TURBO M/T
 <>... CONVERTIBLE MODEL
 []... WITH COMPACT DISC

50 WIRING DIAGRAM

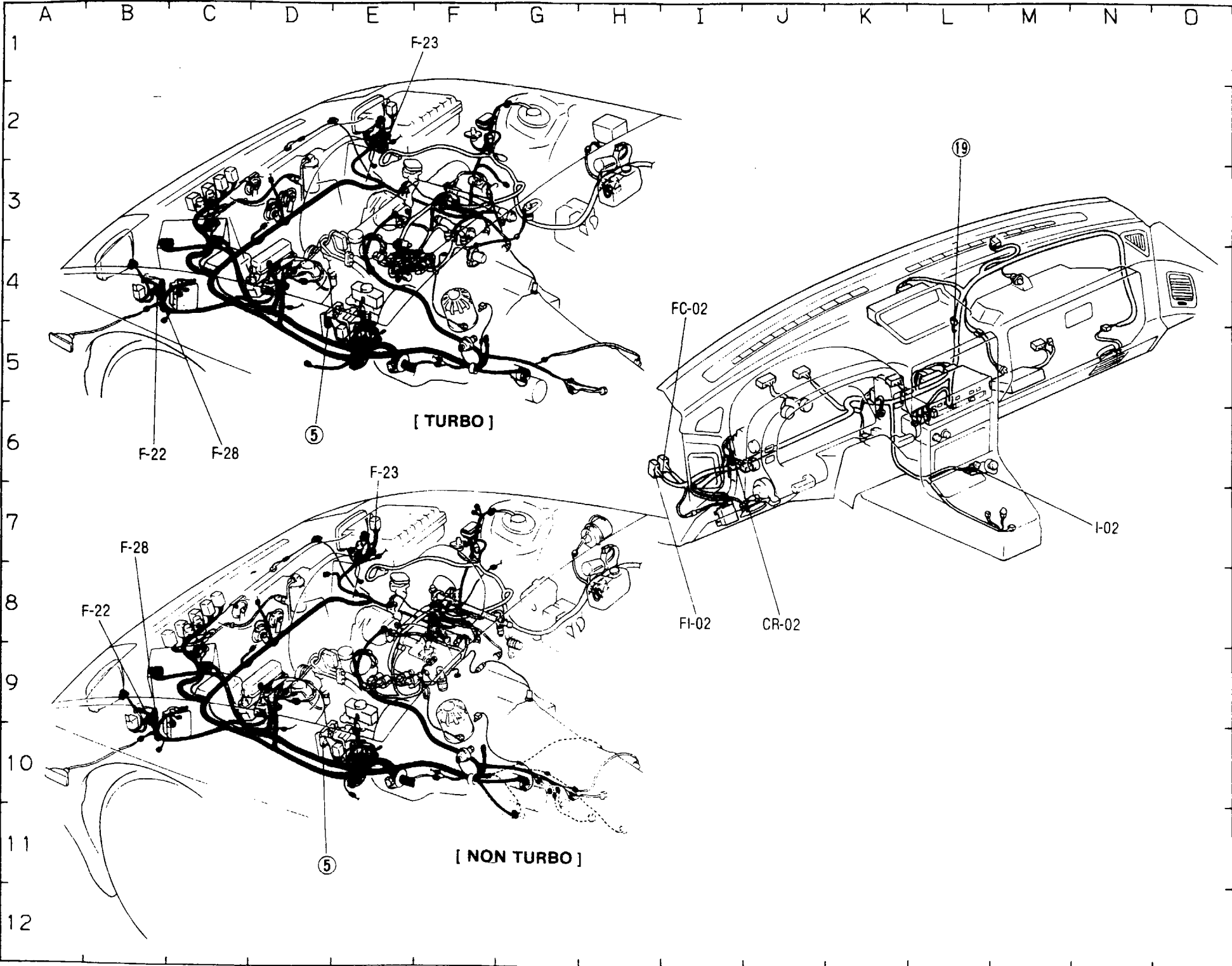

▪ COMBINATION LIGHTS ▪ LICENSE LIGHTS ▪ STORAGE BOX LIGHTS ▪ GLOVE BOX LIGHT

A
2
1
S
B

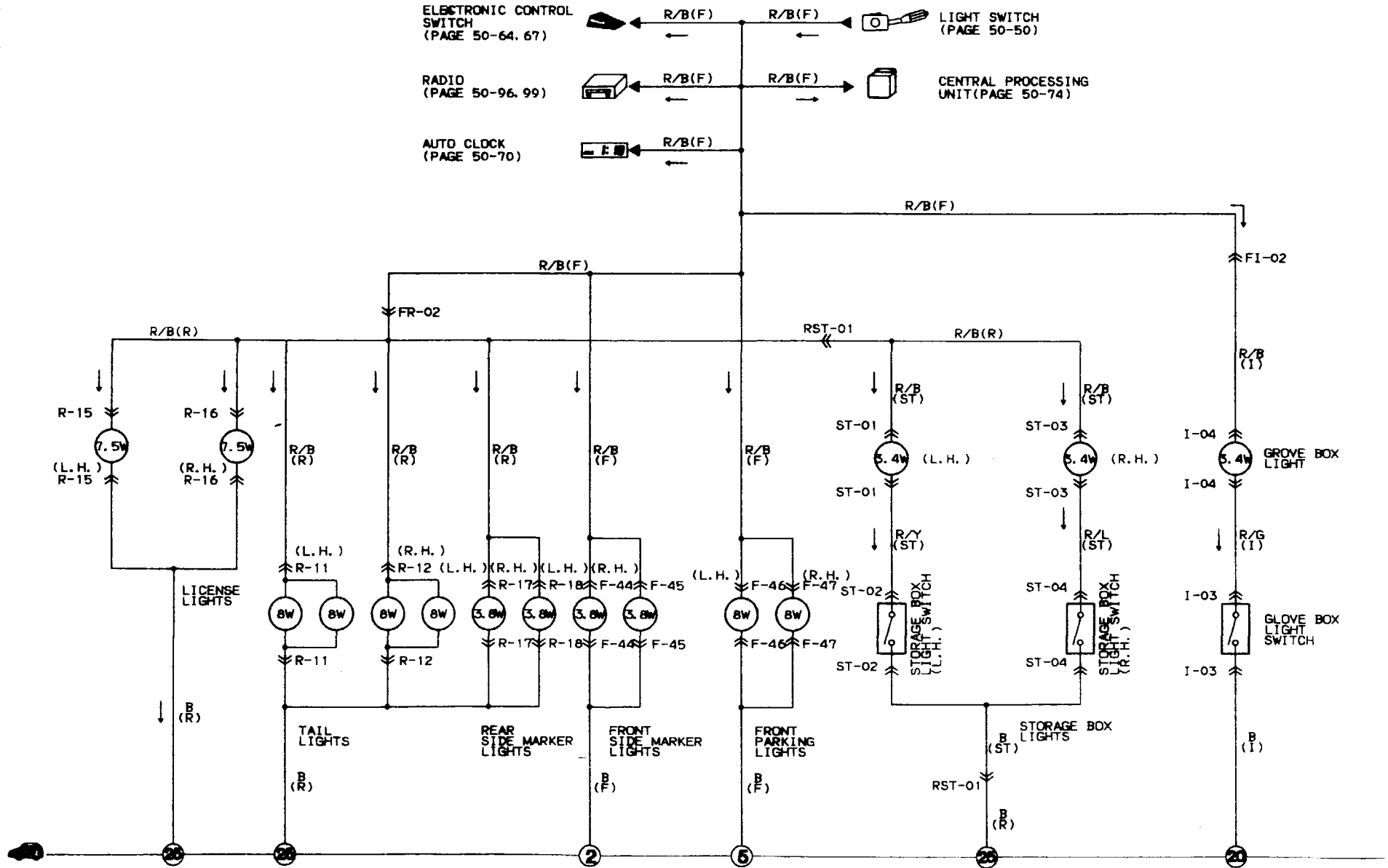

F-44 FRONT SIDE MARKER LIGHTS(L.H.)(F)

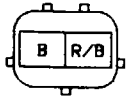

F-45 FRONT SIDE MARKER LIGHTS(R.H.)(F)

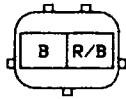

F-46 FRONT PARKING LIGHT (L.H.)(F)

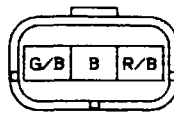

F-47 FRONT PARKING LIGHT (R.H.)(F)

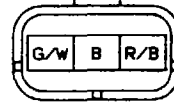

I-03 GLOVE BOX LIGHT SWITCHG(I)

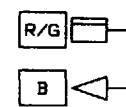

I-04 GLOVE BOX LIGHT(I)



R-11 REAR COMBINATION LIGHT (L.H.)(R)

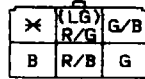

()... CONVERTIBLE MODEL

R-12 REAR COMBINATION LIGHT (R.H.)(R)

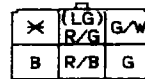

()... CONVERTIBLE MODEL

R-15 LICENSE LIGHT (L.H.)(R)

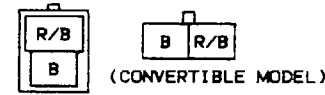

R-16 LICENSE LIGHT (R.H.)(R)

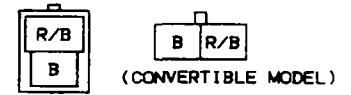

R-17 REAR SIDE MARKER LIGHTS(L.H.)(R)



R-18 REAR SIDE MARKER LIGHTS(R.H.)(R)



ST-01 STORAGE BOX LIGHT (ST)(L.H.)



(EXCEPT CONVERTIBLE MODEL)

ST-02 STORAGE BOX LIGHT SWITCH(ST)(L.H.)



(EXCEPT CONVERTIBLE MODEL)

ST-03 STORAGE BOX LIGHT (ST)(R.H.)



(EXCEPT CONVERTIBLE MODEL)

ST-04 STORAGE BOX LIGHT SWITCH(ST)(R.H.)

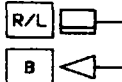

(EXCEPT CONVERTIBLE MODEL)

FI-02 CONNECTOR BETWEEN FRONT(F) AND INSTRUMENT PANEL(I) HARNESS

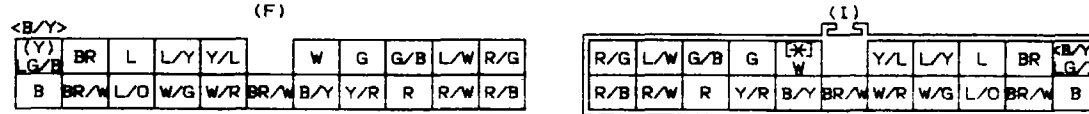

()...NON TURBO M/T <...CONVERTIBLE MODEL [*]...WITH COMPACT DISC

FR-02 CONNECTOR BETWEEN FRONT(F) AND REAR(R) HARNESS

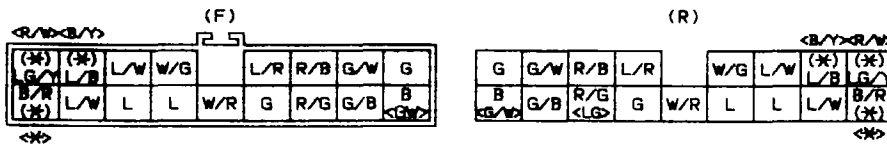

()...LOW GRADE MODEL <...CONVERTIBLE MODEL

RST-01 CONNECTOR BETWEEN REAR(R) AND STORAGE(ST) HARNESS

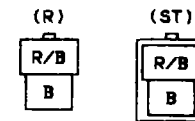

50 WIRING DIAGRAM

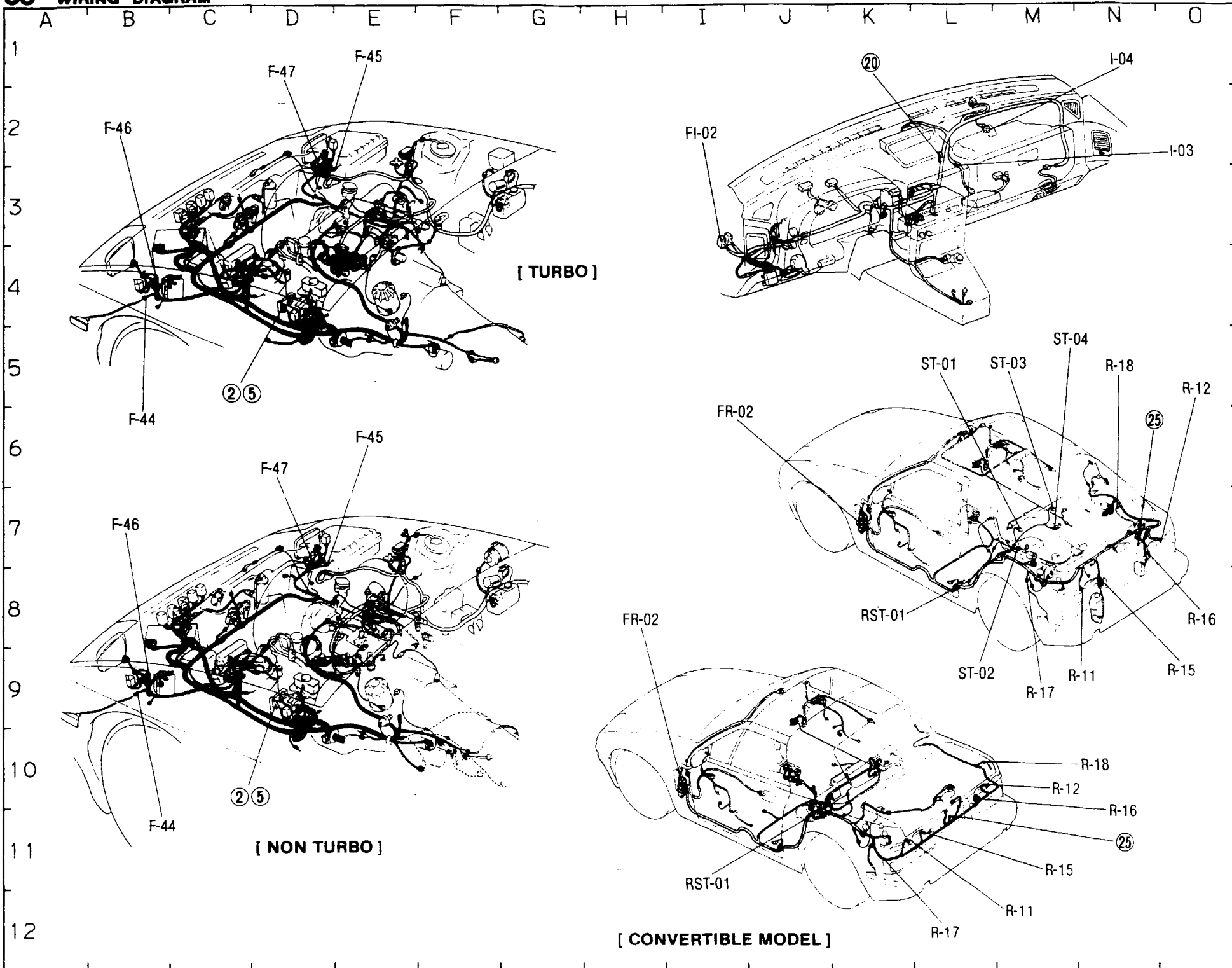

■ STOP LIGHTS ■ HORN

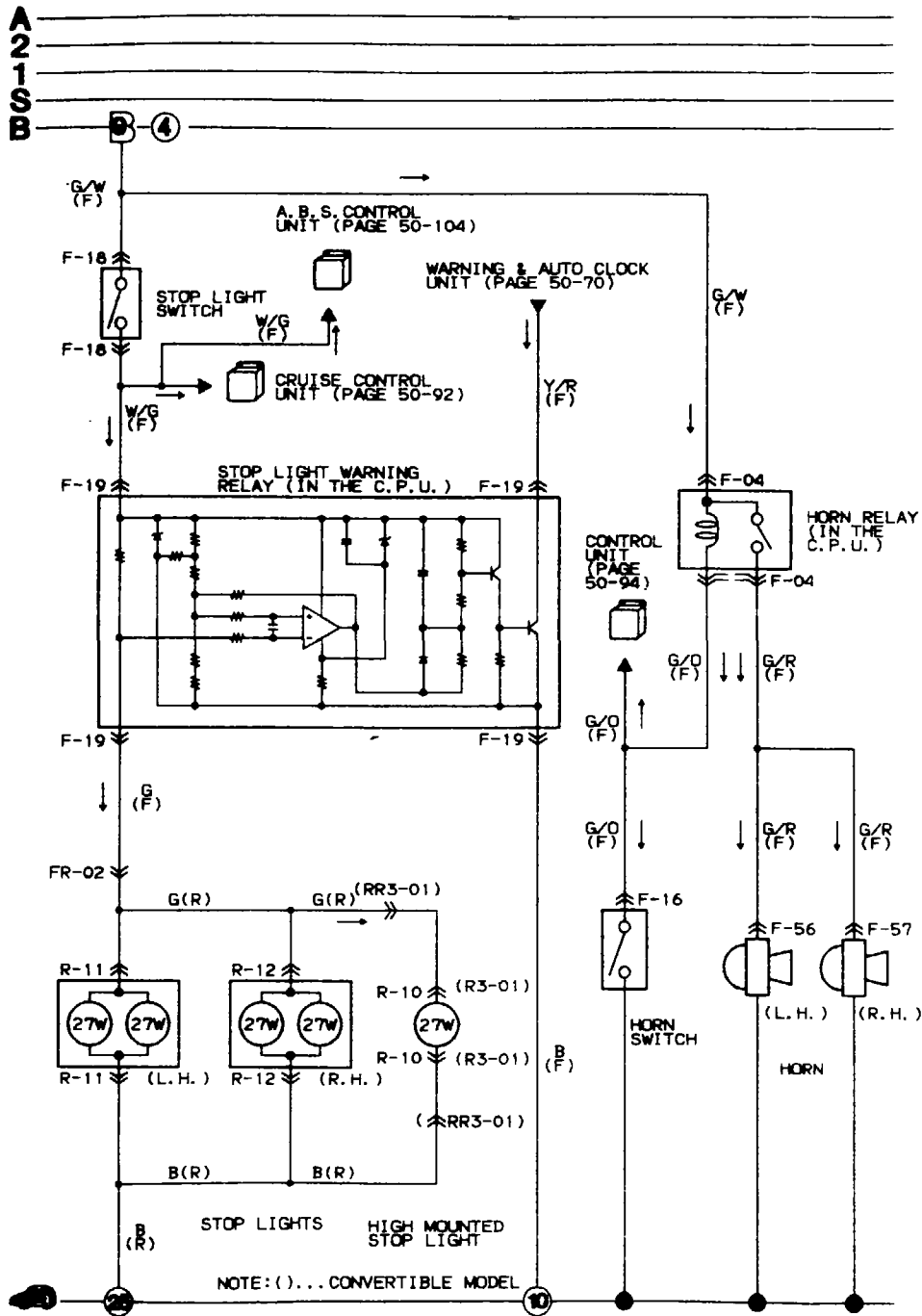

NOTE: ()... CONVERTIBLE MODEL

F-04 HORN RELAY (IN THE C.P.U.) (F)

G/R	G/O	G/W	W/B	Y/L	B/Y	L/R	Y
X	X	R/W	L	B	L/W	Y/R	G/B
							G/W (*)

()... LOW GRADE MODEL

F-16 HORN SWITCH & TURN CANCEL SENSOR (F)

(*) G	(*) G/W	(*) LG
G/R	G/O	X
		G/B

()... LOW GRADE MODEL

F-18 STOP LIGHT SWITCH (F)

G/W
W/G

F-19 STOP LIGHT WARNING RELAY (F) (IN THE C.P.U.)

W/G	Y/R
G	B

F-56 HORN (L.H.) (F)

G/R

F-57 HORN (R.H.) (F)

G/R

R-10 HIGH MOUNTED STOP LIGHT (R)

B	G
---	---

R-11 REAR COMBINATION LIGHT (R)

X	<LG>	G/B
B	R/G	G

<>... CONVERTIBLE MODEL

R-12 REAR COMBINATION LIGHT (R)

X	<LG>	G/W
B	R/B	G

<>... CONVERTIBLE MODEL

R3-01 HIGH MOUNTED STOP LIGHT (R3)

B	G
---	---

(CONVERTIBLE MODEL)

FR-02 CONNECTOR BETWEEN FRONT (F) AND REAR (R) HARNESS

(*) LG	(*) LG	L/W	W/G	L/R	R/B	G/W	G
B/R (*)	L/W (*)	L	L	W/R	G	R/G	G/B
							B/W

()... LOW GRADE MODEL
<>... CONVERTIBLE MODEL

G	G/W	R/B	L/R	W/G	L/W	(*) L/B	(*) G/Y
B	G/B	R/G	G	W/R	L	L/W	B/R (*)
							(*)

RR3-01 CONNECTOR BETWEEN REAR (R) AND NO3 REAR (R3) HARNESS

G	L/R
B	L/G

(R) (CONVERTIBLE MODEL)

L/R	G
L/G	B

(R3)

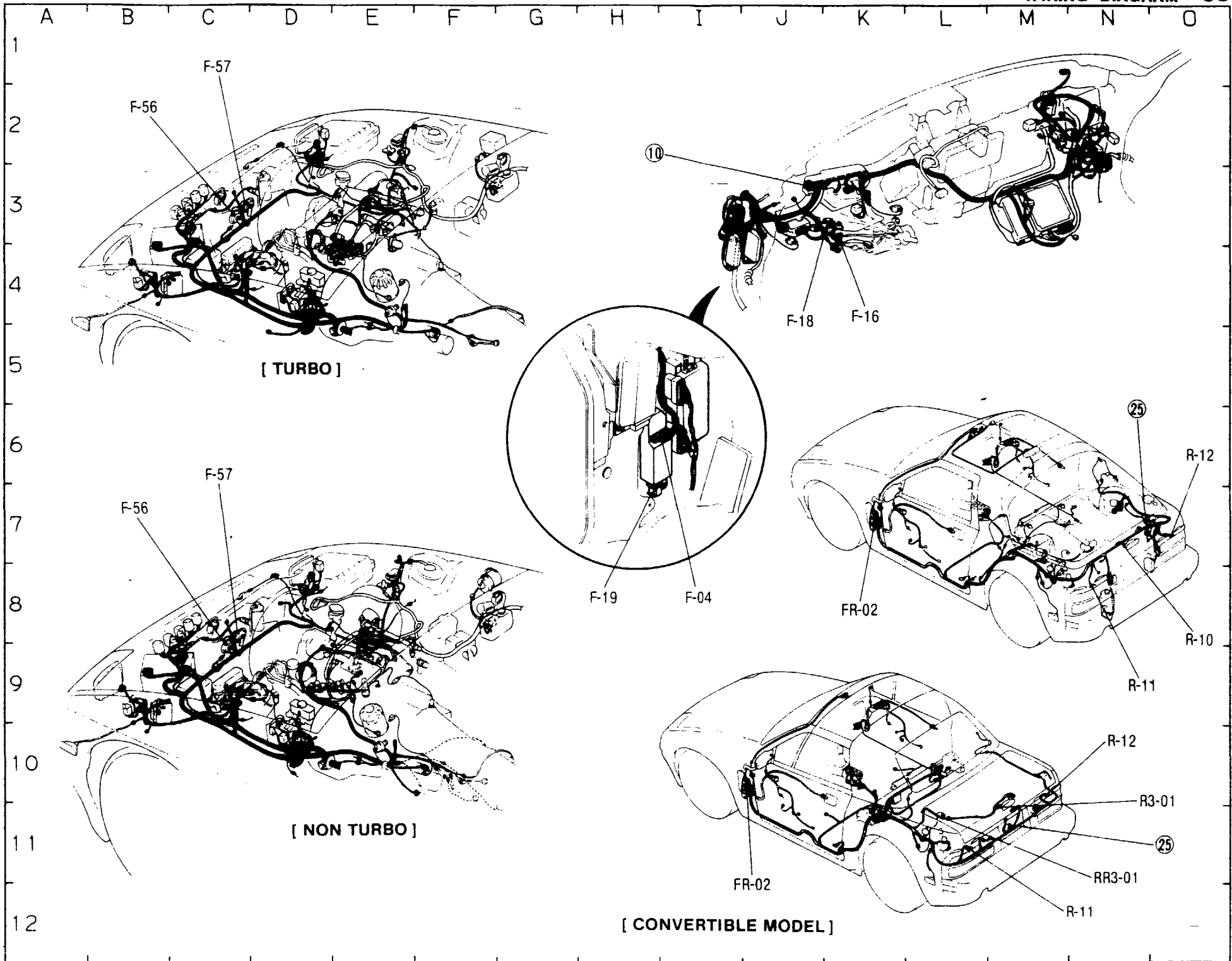

▪ TURN & HAZARD FLASHER LIGHTS ▪ BACK-UP LIGHTS

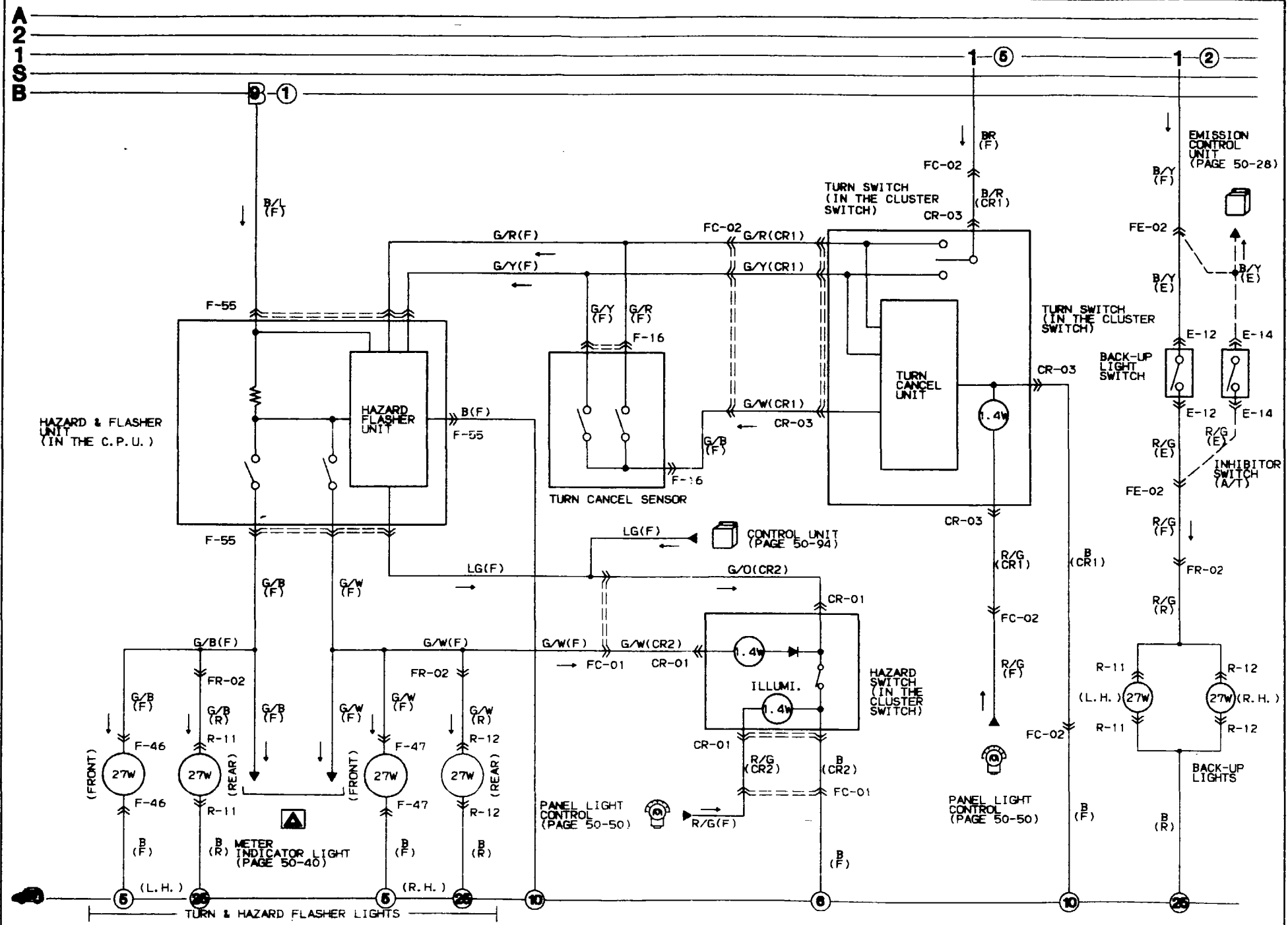

E-12 BACK-UP LIGHT SWITCH(E)



F-16 HORN SWITCH & TURN CANCEL SENSOR(F)

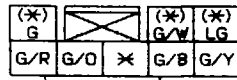

()...LOW GRADE MODEL

F-46 FRONT PARKING LIGHTS(L.H.)(F)

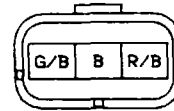

F-47 FRONT PARKING LIGHTS(R.H.)(F)

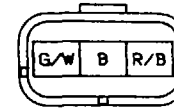

F-55 HAZARD & FLASHER UNIT(F)
(IN THE C.P.U.)

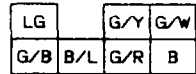

E-14 INHIBITOR SWITCH
(A/T)(E)

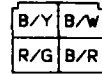

R-11 REAR COMBINATION LIGHT(R)

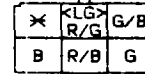

<>... CONVERTIBLE MODEL

R-12 REAR COMBINATION LIGHT(R)

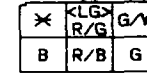

<>... CONVERTIBLE MODEL

CR-01 WIPER & WASHER SWITCH(CR2)

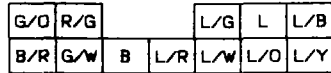

CR-03 DIMMER SWITCH(CR1) (IN THE CLUSTER SWITCH)



FR-02 CONNECTOR BETWEEN FRONT(F) AND REAR(R) HARNESS

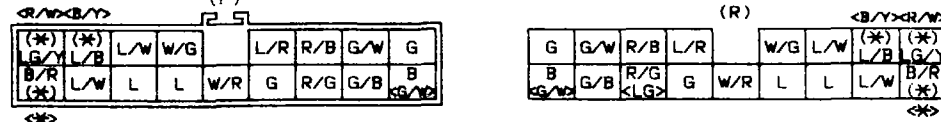

()...LOW GRADE MODEL <>... CONVERTIBLE MODEL

FC-01 CONNECTOR BETWEEN FRONT(F) AND CLUSTER SWITCH(CR2) HARNESS(R.H.)

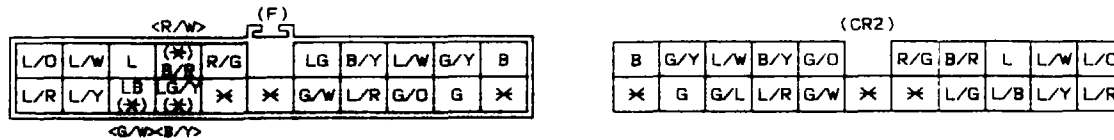

()...LOW GRADE MODEL <>... CONVERTIBLE MODEL

FC-02 CONNECTOR BETWEEN FRONT(F) AND CLUSTER SWITCH(CR1) HARNESS(L.H.)

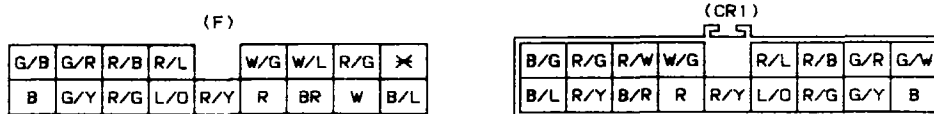

FE-02 CONNECTOR BETWEEN FRONT(F) AND ENGINE(E) HARNESS

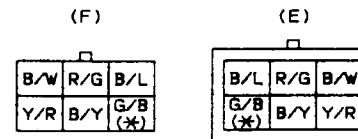

()...A/T

50 WIRING DIAGRAM

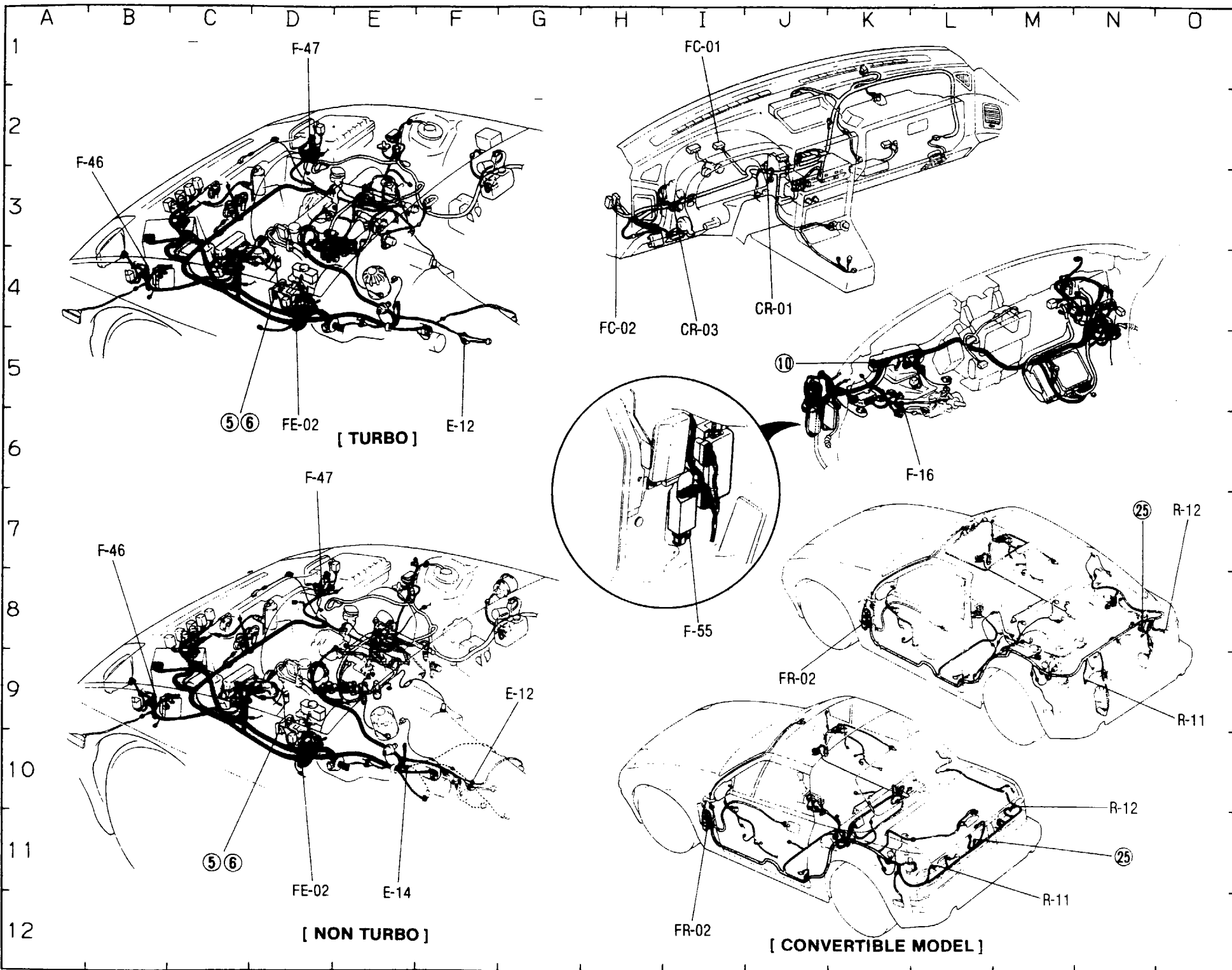

[NON TURBO M/T] ■ HEATER & AIR CONDITIONER

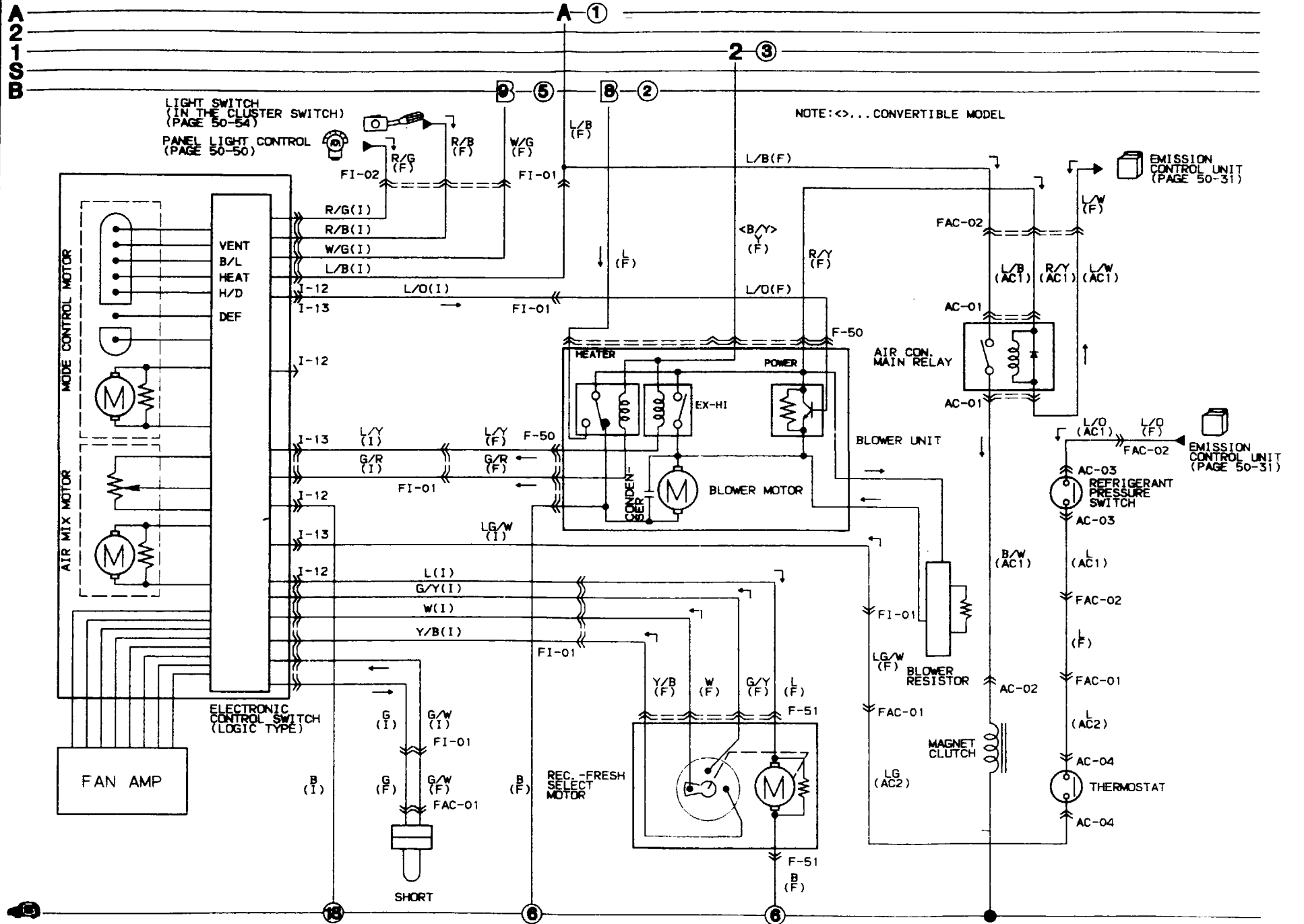

I-12 ELECTRONIC CONTROL SWITCH(I)

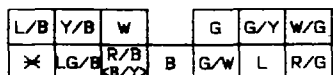

<>... CONVERTIBLE MODEL

I-13 ELECTRONIC CONTROL SWITCH(I)

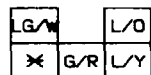

F-50 BLOWER UNIT(F)

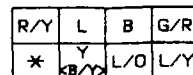

<>... CONVERTIBLE MODEL

F-51 REC.-FRESH SELECT MOTOR(F)

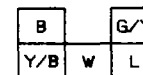

AC-01 AIR CON. MAIN RELAY(AC1)

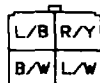

AC-02 MAGNET CLUTCH(AC1)



AC-03 REFRIGERANT PRESSURE SWITCH(AC1)



AC-04 THERMOSTAT(AC2)



FAC-01 CONNECTOR BETWEEN FRONT(F) AND AIR CON. (AC2) HARNESS

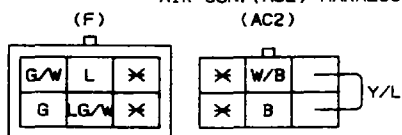

FAC-02 CONNECTOR BETWEEN FRONT(F) AND AIR CON. (AC1) HARNESS

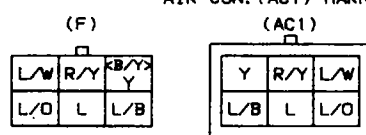

<>... CONVERTIBLE MODEL

FI-01 CONNECTOR BETWEEN FRONT(F) AND INSTRUMENT PANEL(I) HARNESS

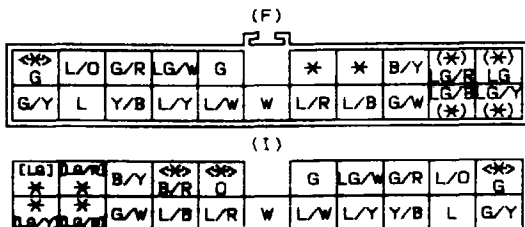

()...LOW GRADE MODEL <>...CONVERTIBLE MODEL
 []...WITH COMPACT DISC

FI-02 CONNECTOR BETWEEN FRONT(F) AND INSTRUMENT PANEL(I) HARNESS

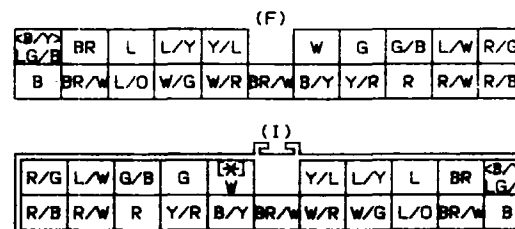

<>... CONVERTIBLE MODEL
 []...WITH COMPACT DISC

50 WIRING DIAGRAM

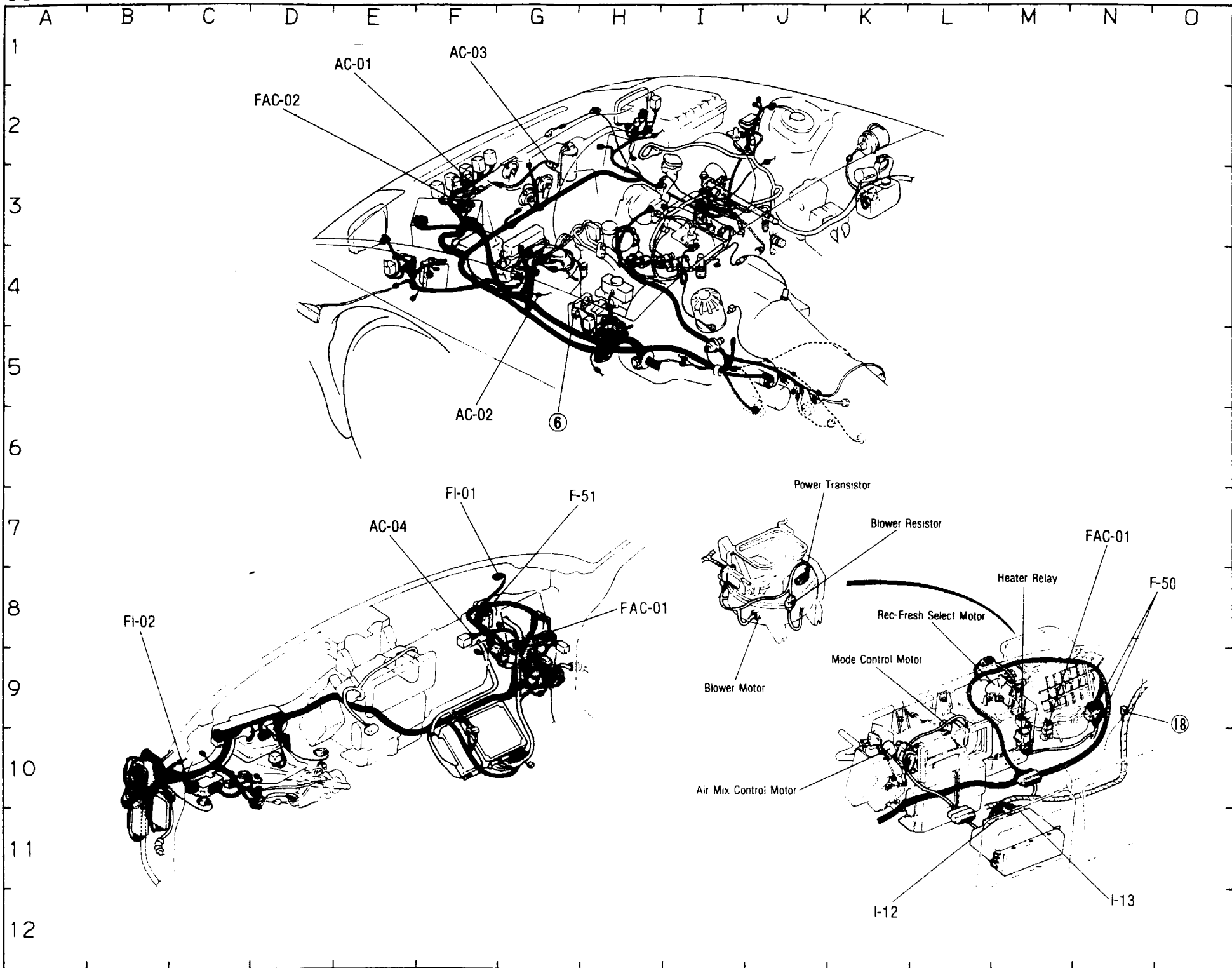

EXCEPT NON TURBO M/T HEATER & AIR CONDITIONER

A
2
1
S
B

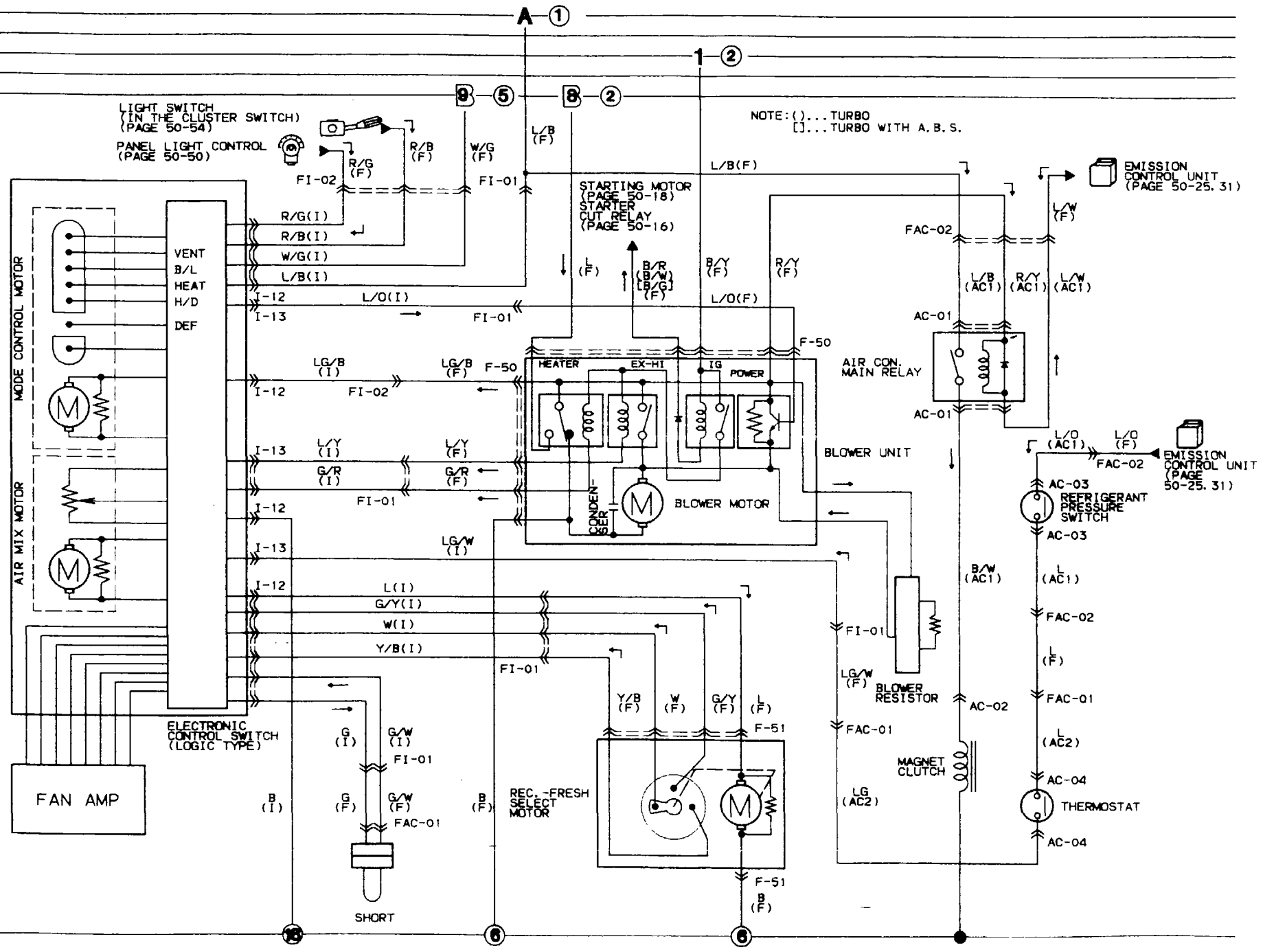

I-12 ELECTRONIC CONTROL SWITCH(I)

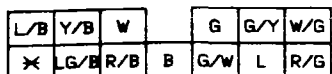

I-13 ELECTRONIC CONTROL SWITCH(I)



F-50 BLOWER UNIT(F)

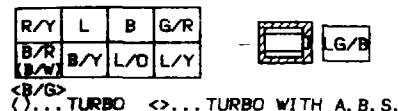

F-51 REC.-FRESH SELECT MOTOR(F)

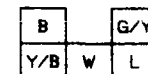

AC-01 AIR CON. MAIN RELAY(AC1)



AC-02 MAGNET CLUTCH(AC1)



AC-03 REFRIGERANT PRESSURE SWITCH(AC1)



AC-04 THERMOSTAT(AC2)



FAC-01 CONNECTOR BETWEEN FRONT(F) AND AIR CON. (AC2) HARNESS

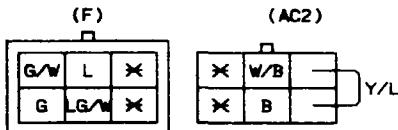

FAC-02 CONNECTOR BETWEEN FRONT(F) AND AIR CON. (AC1) HARNESS

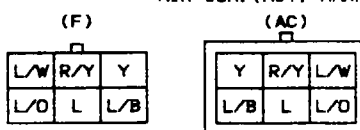

FI-01 CONNECTOR BETWEEN FRONT(F) AND INSTRUMENT PANEL(I) HARNESS

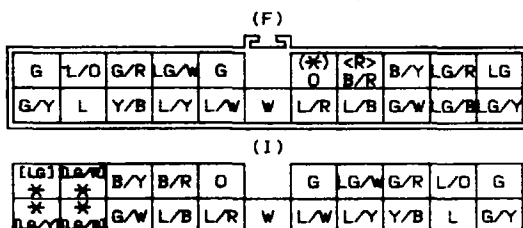

()...TURBO <>...WITH A. B. S.
(*)...WITH COMPACT DISC

FI-02 CONNECTOR BETWEEN FRONT(F) AND INSTRUMENT PANEL(I) HARNESS

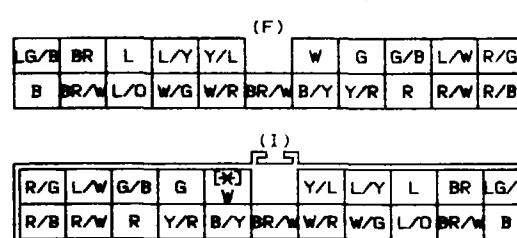

[]...WITH COMPACT DISC

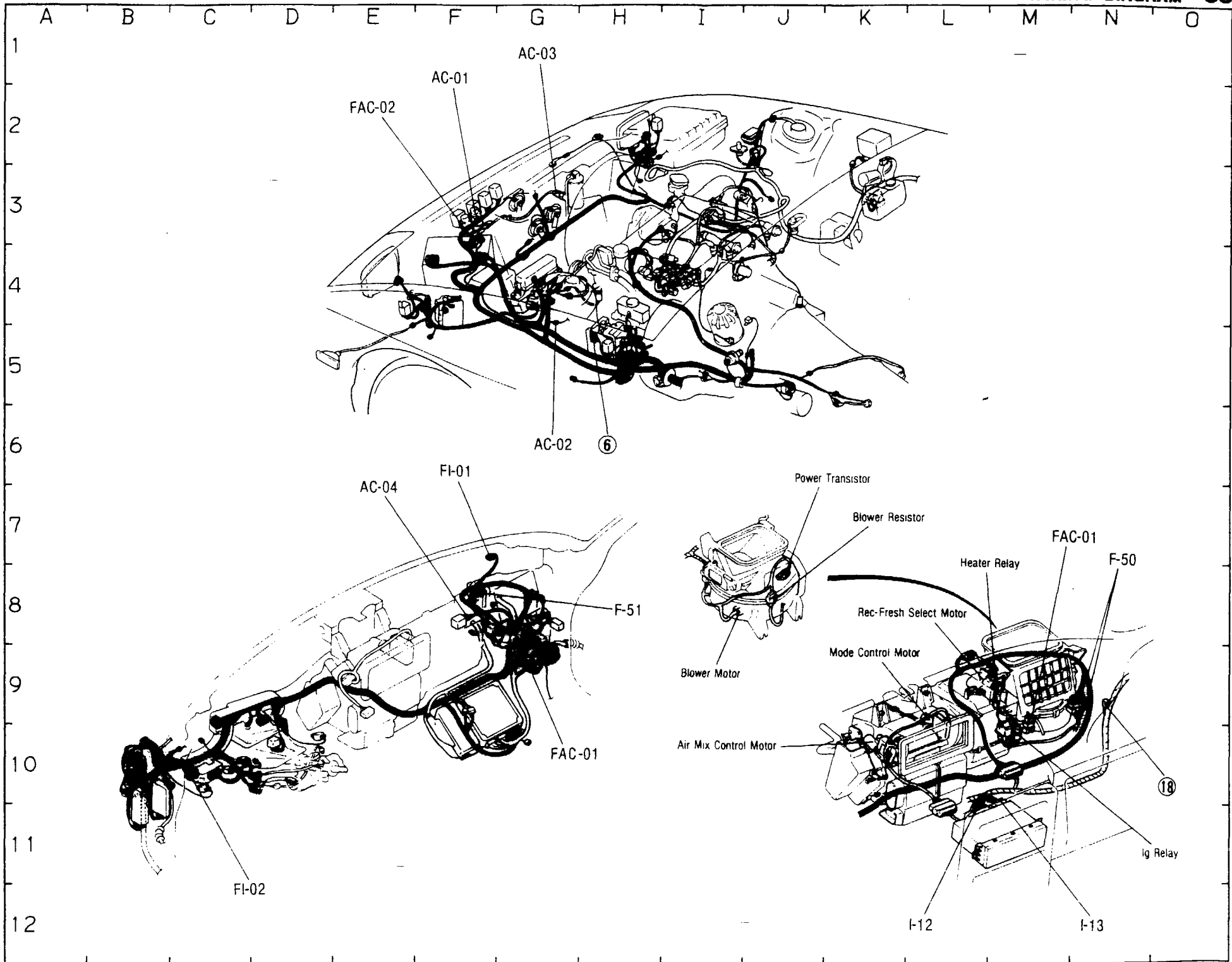

WARNING & AUTO CLOCK SYSTEM

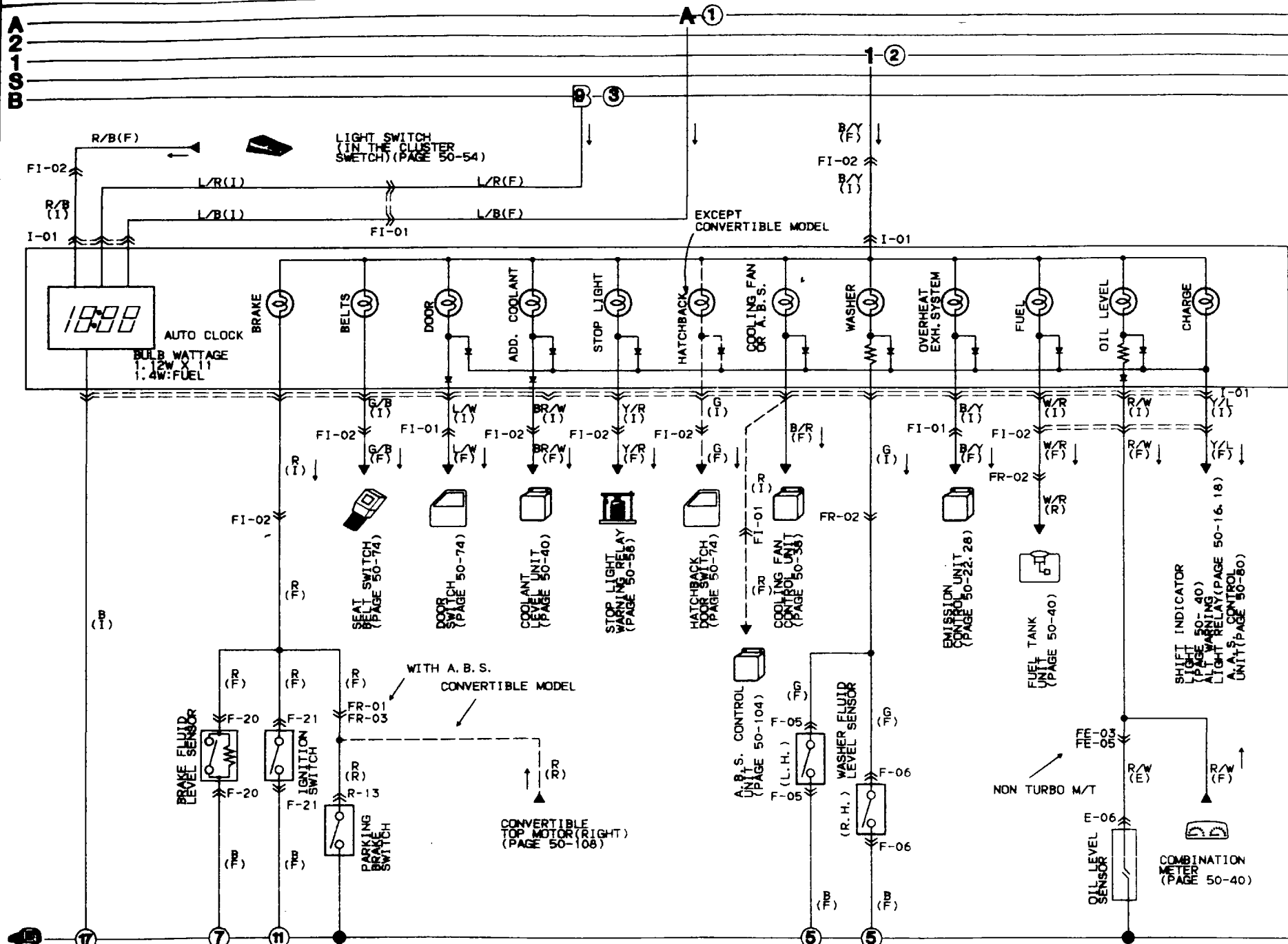

I-01 WARNING & AUTO CLOCK UNIT(I)

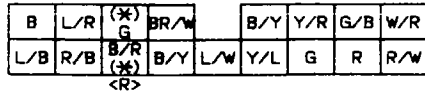

()... CONVERTIBLE MODEL <>... WITH A. B. S.

F-05 WASHER FLUID LEVEL SENSOR(F) (L.H.)

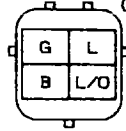

F-06 WASHER FLUID LEVEL SENSOR(F) (R.H.)

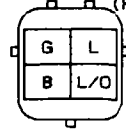

F-20 BRAKE FLUID LEVEL SENSOR(F)

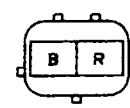

F-21 IGNITION SWITCH(F)



E-06 OIL LEVEL SENSOR(E)



R-13 PRKING BRAKE SWITCH(R)



FE-03 CONNECTOR BETWEEN FRONT(F) AND ENGINE(E) HARNESS

(NON TURBO)

(TURBO)

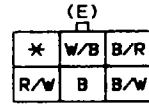
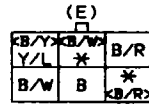
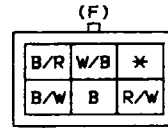
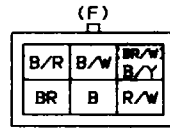

()... WITH A. B. S. <>... A/T

FE-05 CONNECTOR BETWEEN FRONT(F) AND ENGINE(E) HARNESS

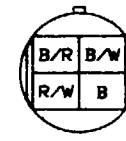
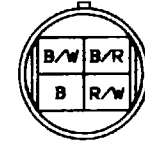

FR-01 CONNECTOR BETWEEN FRONT(F) AND REAR(R) HARNESS

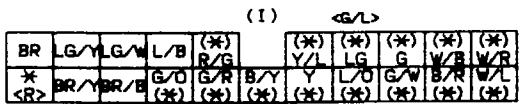
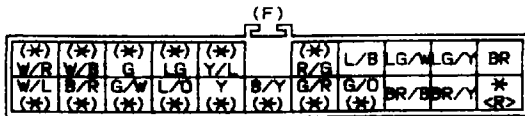

()... LOW GRADE MODEL <>... WITH A. B. S.

FR-02 CONNECTOR BETWEEN FRONT(F) AND REAR(R) HARNESS

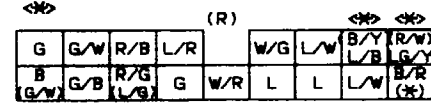
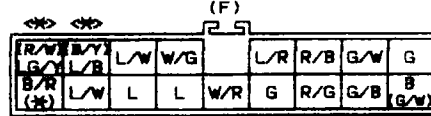

()... CONVERTIBLE MODEL <>... LOW GRADE MODEL

FR-03 CONNECTOR BETWEEN FRONT(F) AND REAR(R) HARNESS

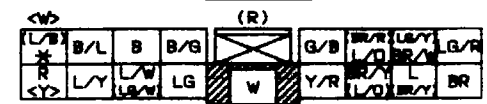
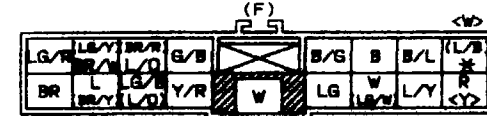

()... CONVERTIBLE MODEL <>... WITH A. B. S.

FI-01 CONNECTOR BETWEEN FRONT(F) AND INSTRUMENT PANEL(I) HARNESS

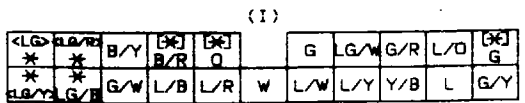
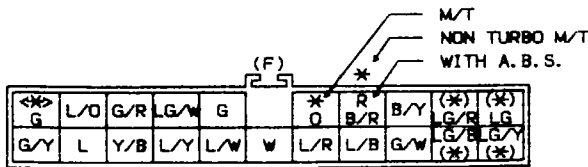

()... LOW GRADE MODEL <>... WITH COMPACT DISC
[]... CONVERTIBLE MODEL

FI-02 CONNECTOR BETWEEN FRONT(F) AND INSTRUMENT PANEL(I) HARNESS

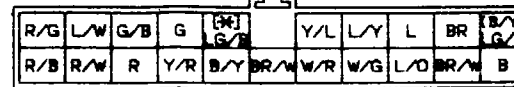
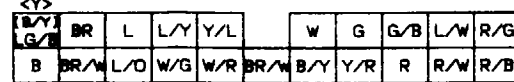

()... COVERTIBLE MODEL <>... NON TURBO M/T
[]... WITH COMPACT DISC

50 WIRING DIAGRAM

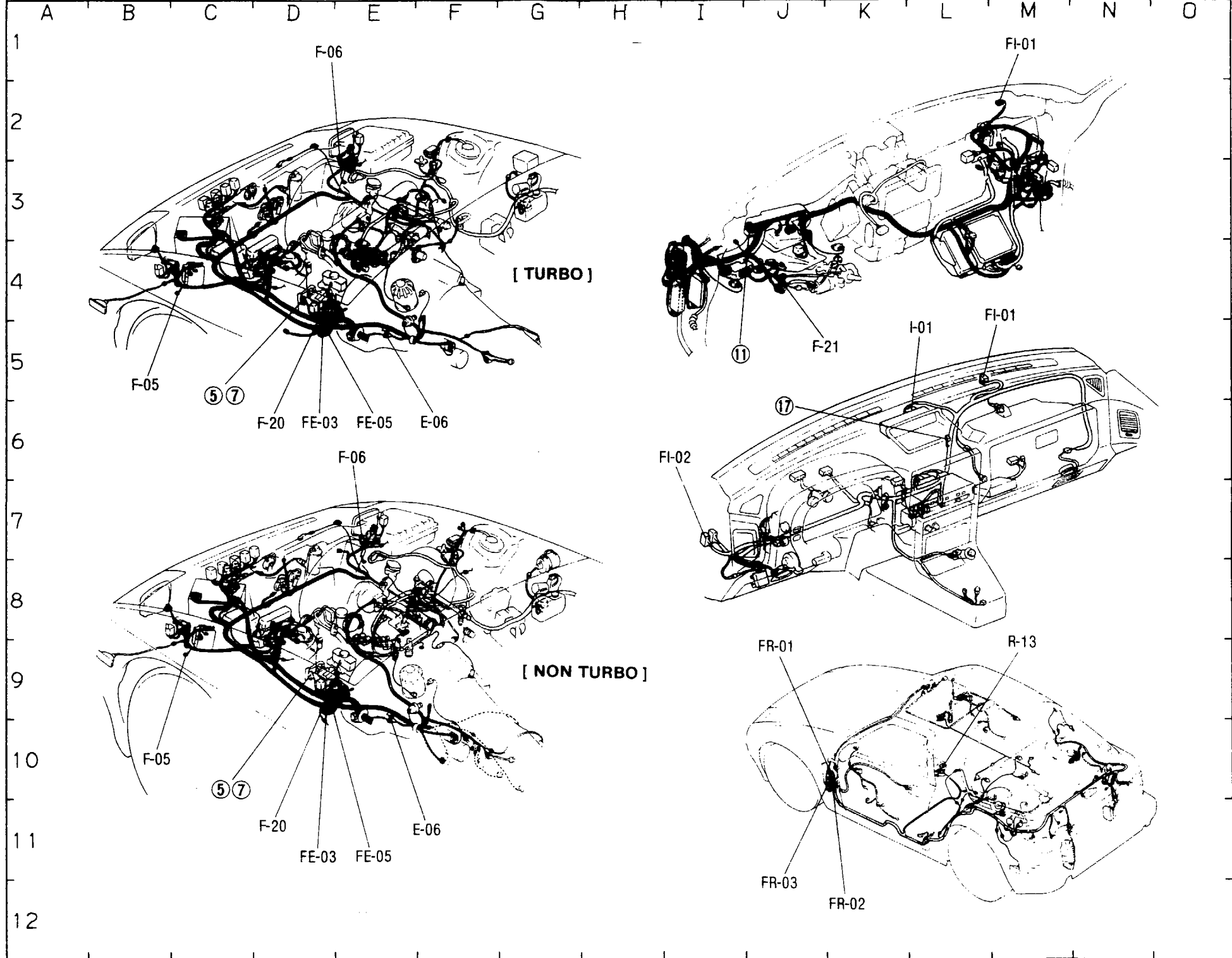

- CARGO ROOM LIGHT ▪ COURTESY LIGHTS ▪ INTERIOR & SPOT LIGHTS
- WARNING BUZZER OR CHIME ▪ DOOR LOCK CYLINDER & IGNITION KEY CYLINDER LIGHTS

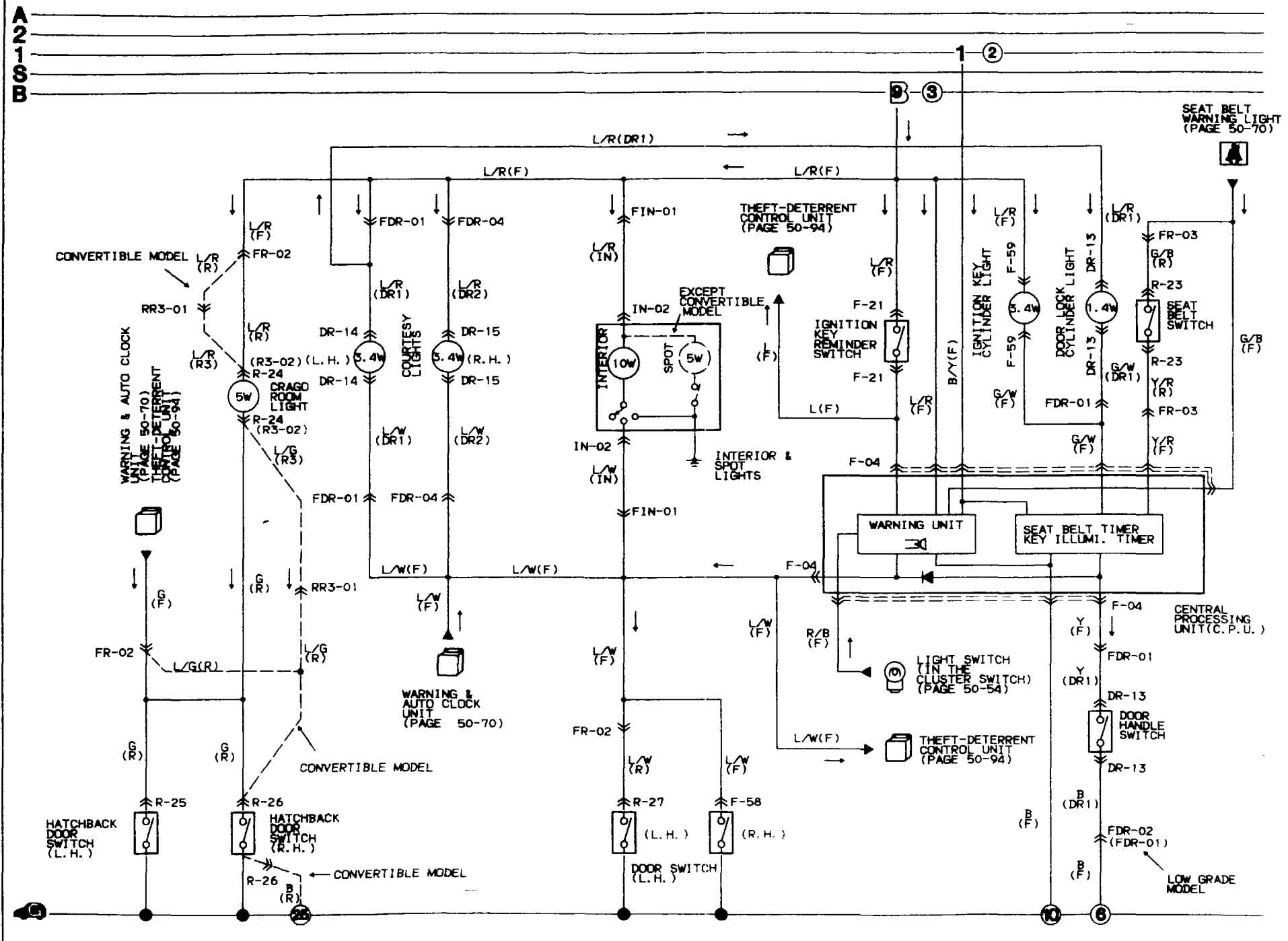

F-04 CENTRAL PROCESSING UNIT (C.P.U.)(F)

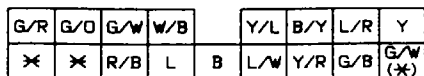

()...LOW GRADE MODEL

R-23 SEAT BELT SWITCH(R)



R-24 CARGO ROOM LIGHT

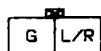

F-21 IGNITION KEY REMINDER SWITCH(F)



F-58 DOOR SWITCH(F) (R.H.)



F-59 IGNITION KEY CYLINDER LIGHT(F)



R3-02 CARGO ROOM LIGHT(R3)



(CONVERTIBLE MODEL)

IN-02 INTERIOR & SPOT LIGHTS(IN)



DR-13 DOOR LOCK CYLINDER LIGHT(DR1)



()...LOW GRADE MODEL

DR-14 COURTESY LIGHT (DR1)(L.H.)



DR-15 COURTESY LIGHT (DR2)(R.H.)



FIN-01 CONNECTOR BETWEEN FRONT(F) AND INTERIOR LIGHT(IN) HARNESS

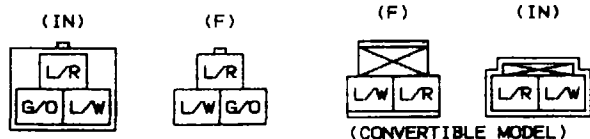

FR-02 CONNECTOR BETWEEN FRONT(F) AND REAR(R) HARNESS

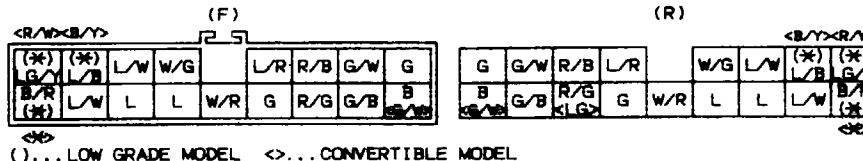

FR-03 CONNECTOR BETWEEN FRONT(F) AND REAR(R) HARNESS

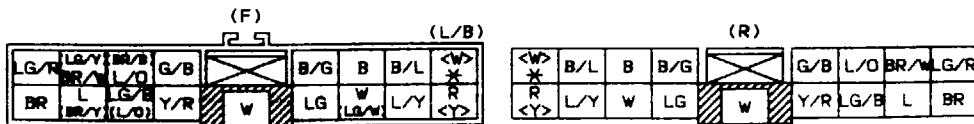

<>...WITH A.B.S. ()...LOW GRADE MODEL

FDR-01 CONNECTOR BETWEEN FRONT(F) AND NO.1 DOOR(DR1) HARNESS

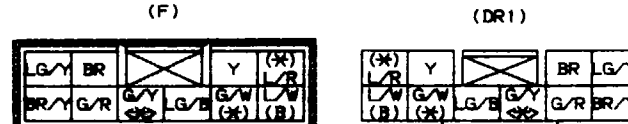

()...LOW GRADE MODEL <>...CONVERTIBLE MODEL

FDR-02 CONNECTOR BETWEEN FRONT(F) AND NO.1 DOOR(DR1) HARNESS (EXCEPT LOW GRADE MODEL)



FDR-04 CONNECTOR BETWEEN FRONT(F) AND NO.2 DOOR(DR2) HARNESS(R.H.)



50 WIRING DIAGRAM

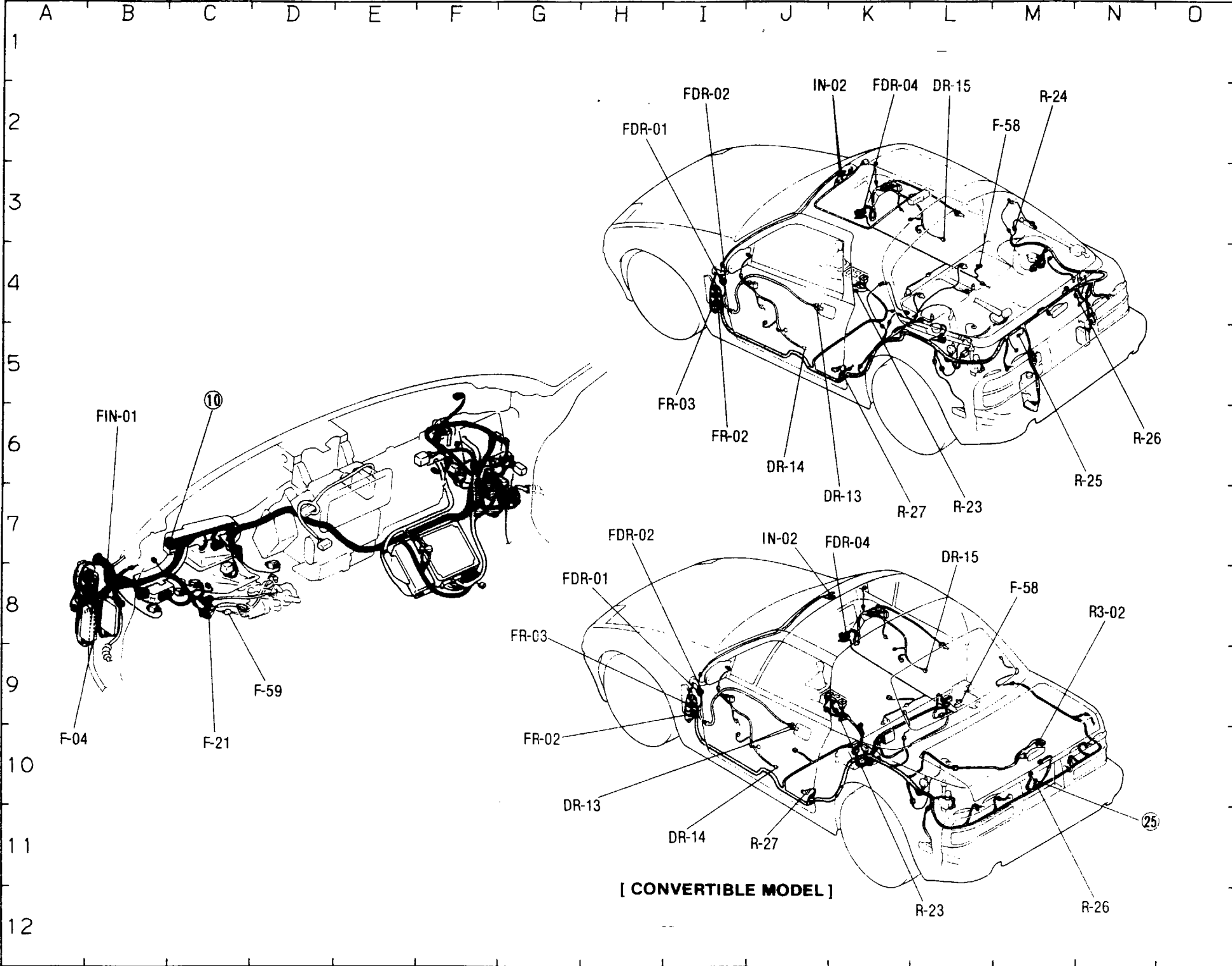

[CONVERTIBLE MODEL]

POWER STEERING CONTROL SYSTEM

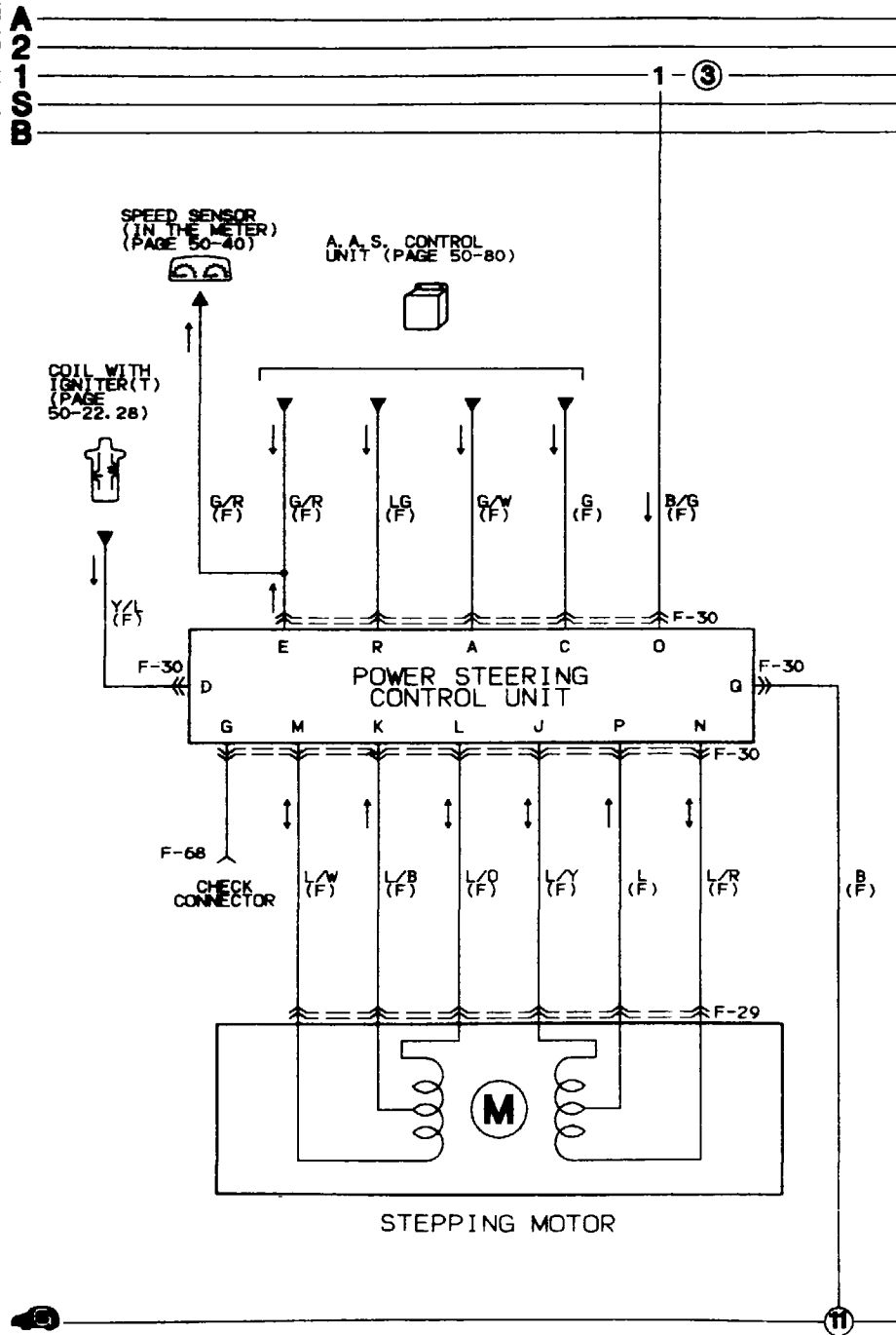

F-29 STEPPING MOTOR(F)

L/B	L/Y	L/R
L/W	L/D	L

F-30 POWER STEERING CONTROL UNIT(F)

G	O	M	K	G	E	C	A
B	B/G	L/W	L/B	W	G/R	G	G/W
LG	L	L/R	L/D	L/Y	*	* Y/L	*

R P N L J H F D B
 <>... CONVERTIBLE MODEL

F-68 CHECK CONNECTOR(F)



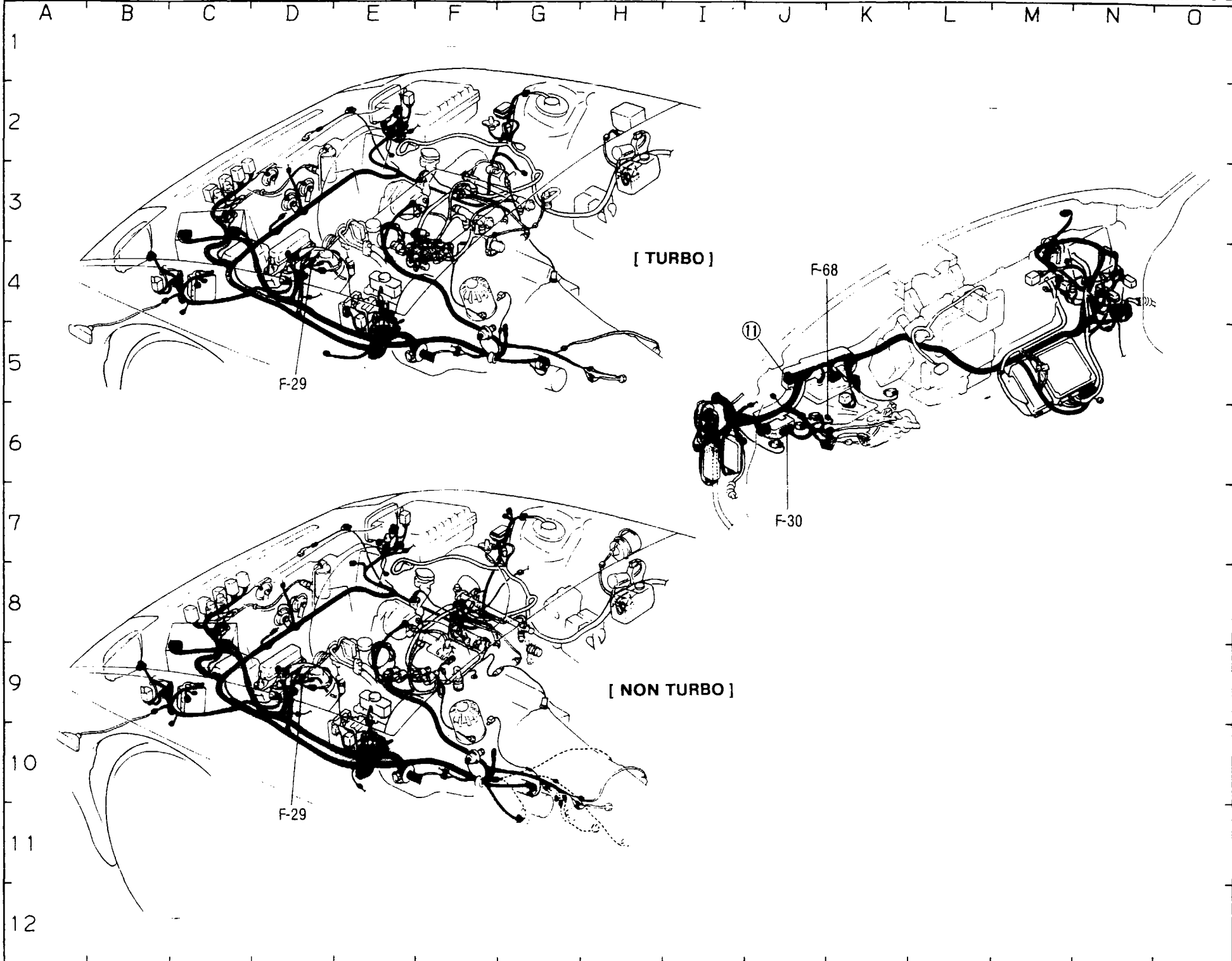

▪ AUTO ADJUSTING SUSPENSION CONTROL SYSTEM

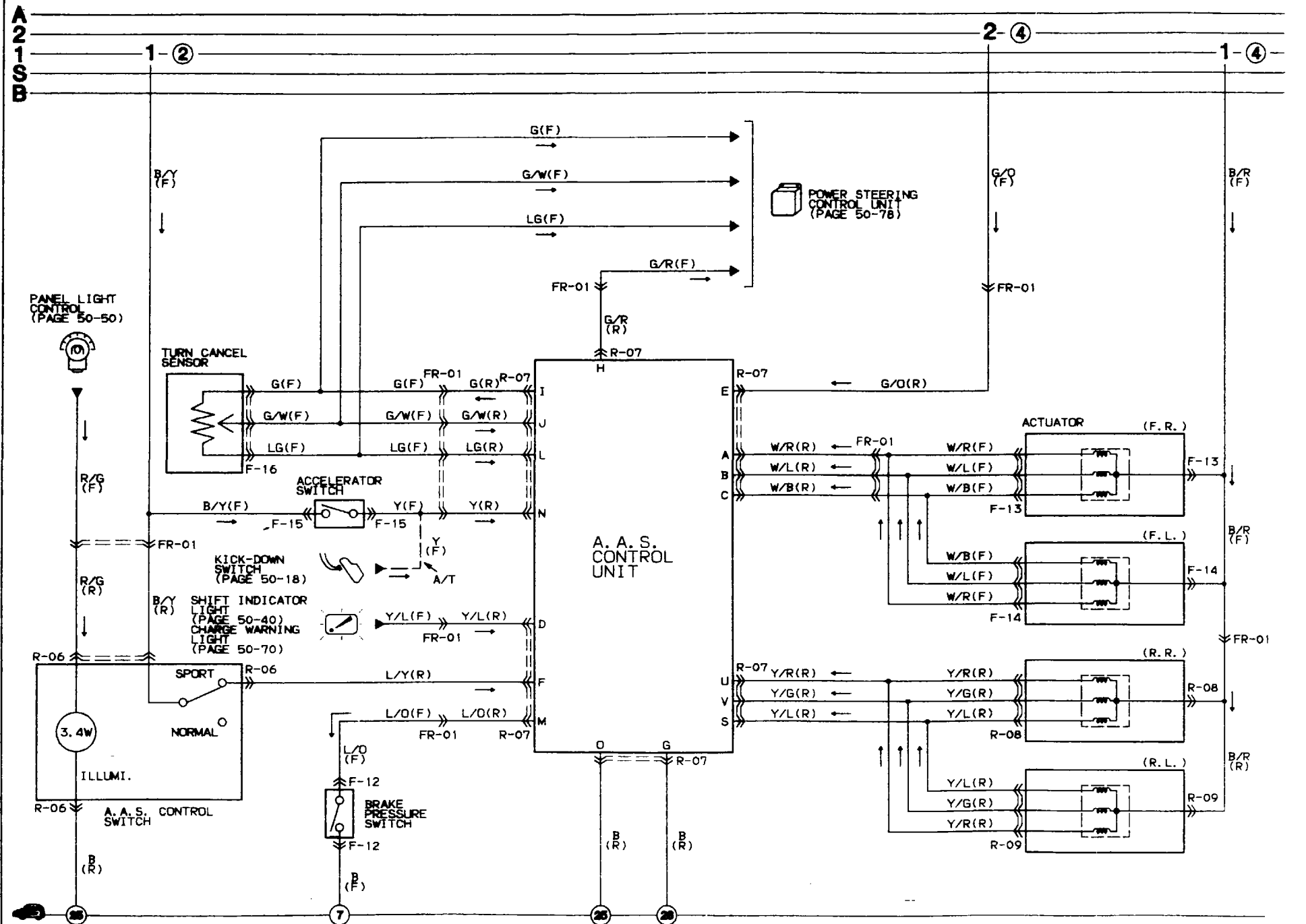

F-12 BRAKE PRESSURE SWITCH(F)



F-13 ACTUATOR(F.R.)(F)

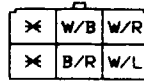

F-14 ACTUATOR(F.L.)(F)

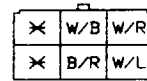

F-15 ACCELERATOR SWITCH(F)



()...NON TURBO WITH A.B.S. OR A/T

F-16 HORN SWITCH & TURN CANCEL SENSOR(F)

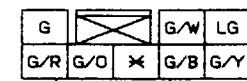

R-06 A. A. S. CONTROL SWITCH(R) R-07 A. A. S. CONTROL UNIT(R)

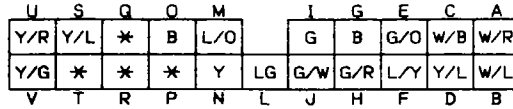
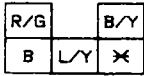

R-08 ACTUATOR(R.R.)(R)

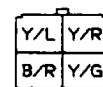

R-09 ACTUATOR(R.L.)(R)

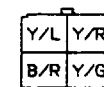

FR-01 CONNECTOR BETWEEN FRONT(F) AND REAR(R) HARNESS

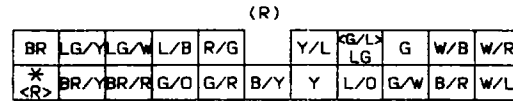
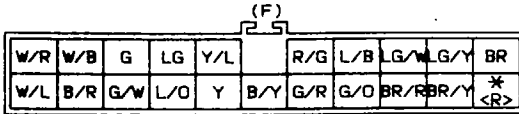

<>... WITH A. B. S.

50 WIRING DIAGRAM

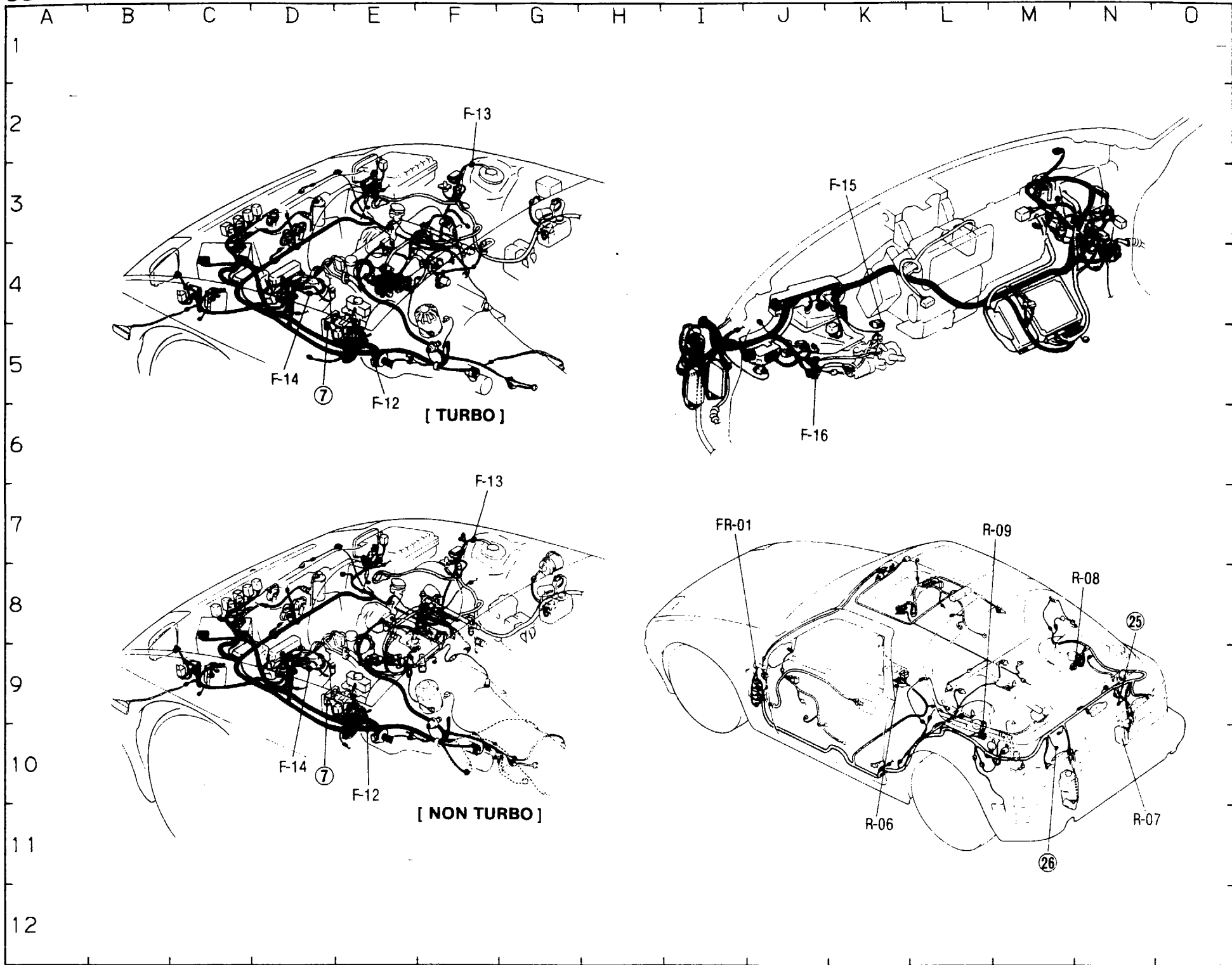

SLIDING SUNROOF

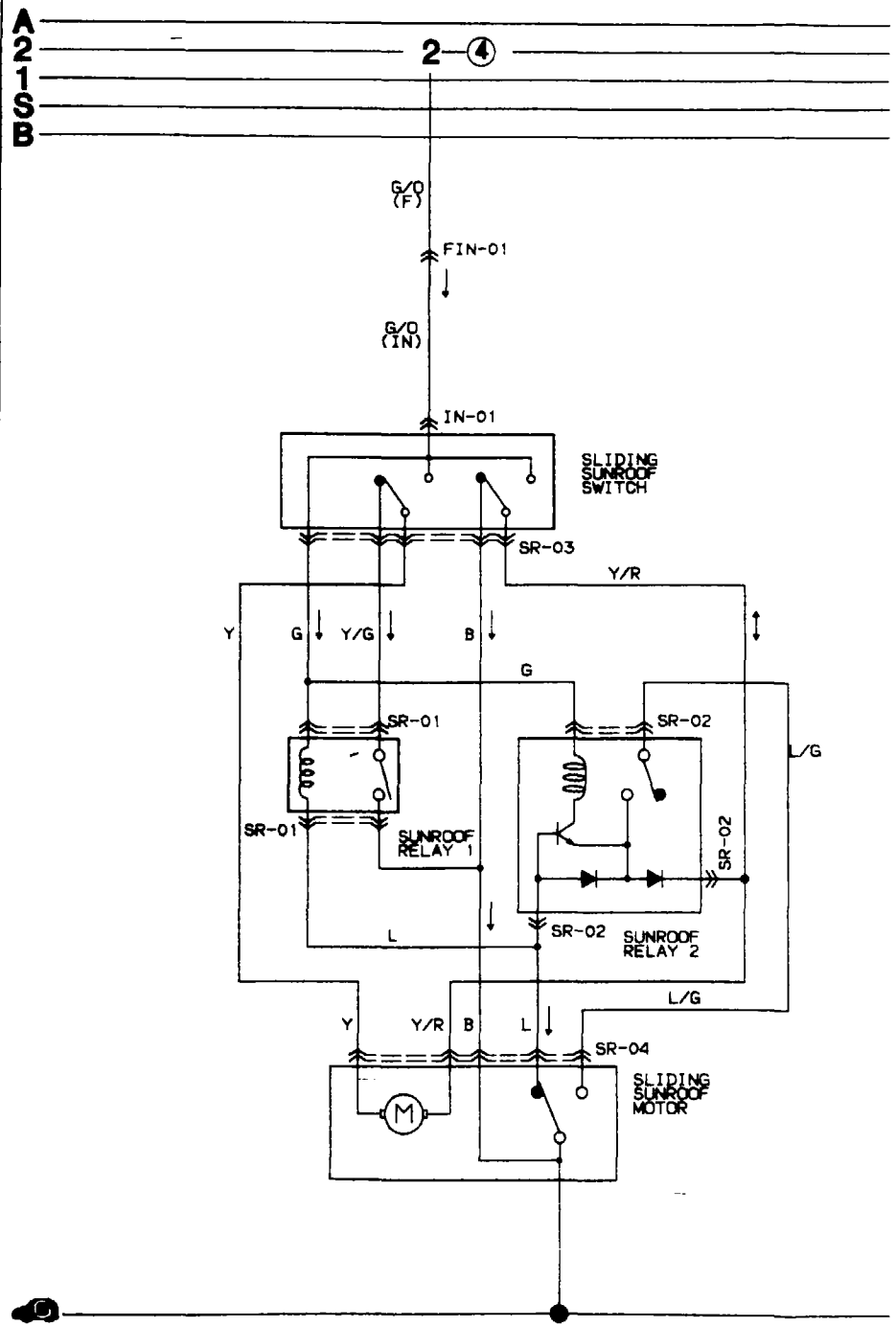

IN-01 SLIDING SUNROOF SWITCH(IN) SR-01 SUNROOF RELAY 1

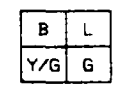

SR-02 SUNROOF RELAY 2

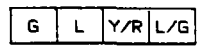

SR-03 SLIDING SUNROOF SWITCH

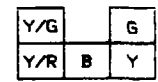

SR-04 SLIDING SUNROOF MOTOR

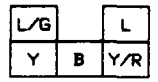

FIN-01 CONNECTOR BETWEEN FRONT(F) AND INTERIOR LIGHT HARNESS(IN)

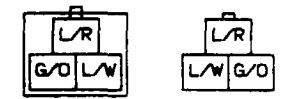

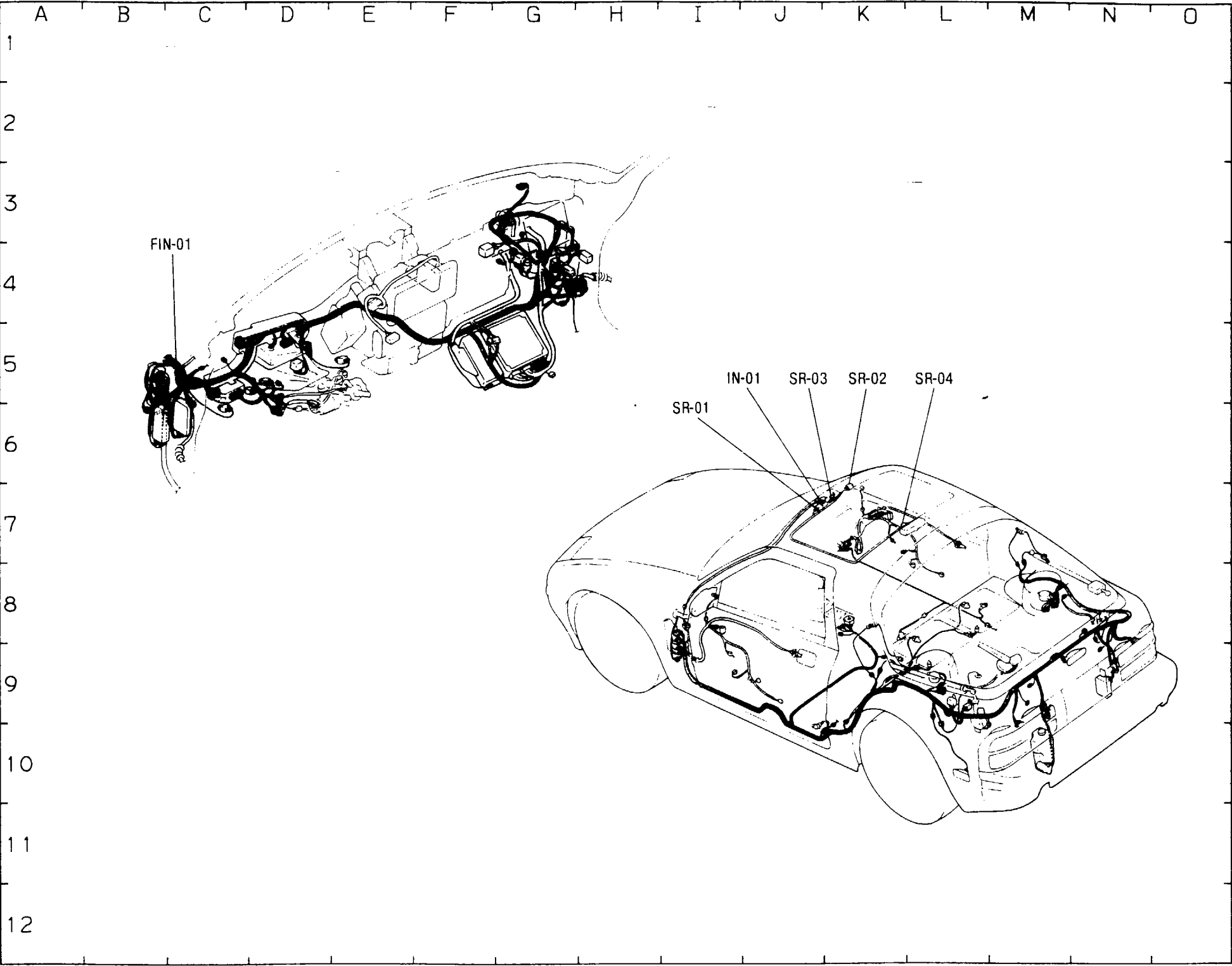

REAR WINDOW DEFROSTER

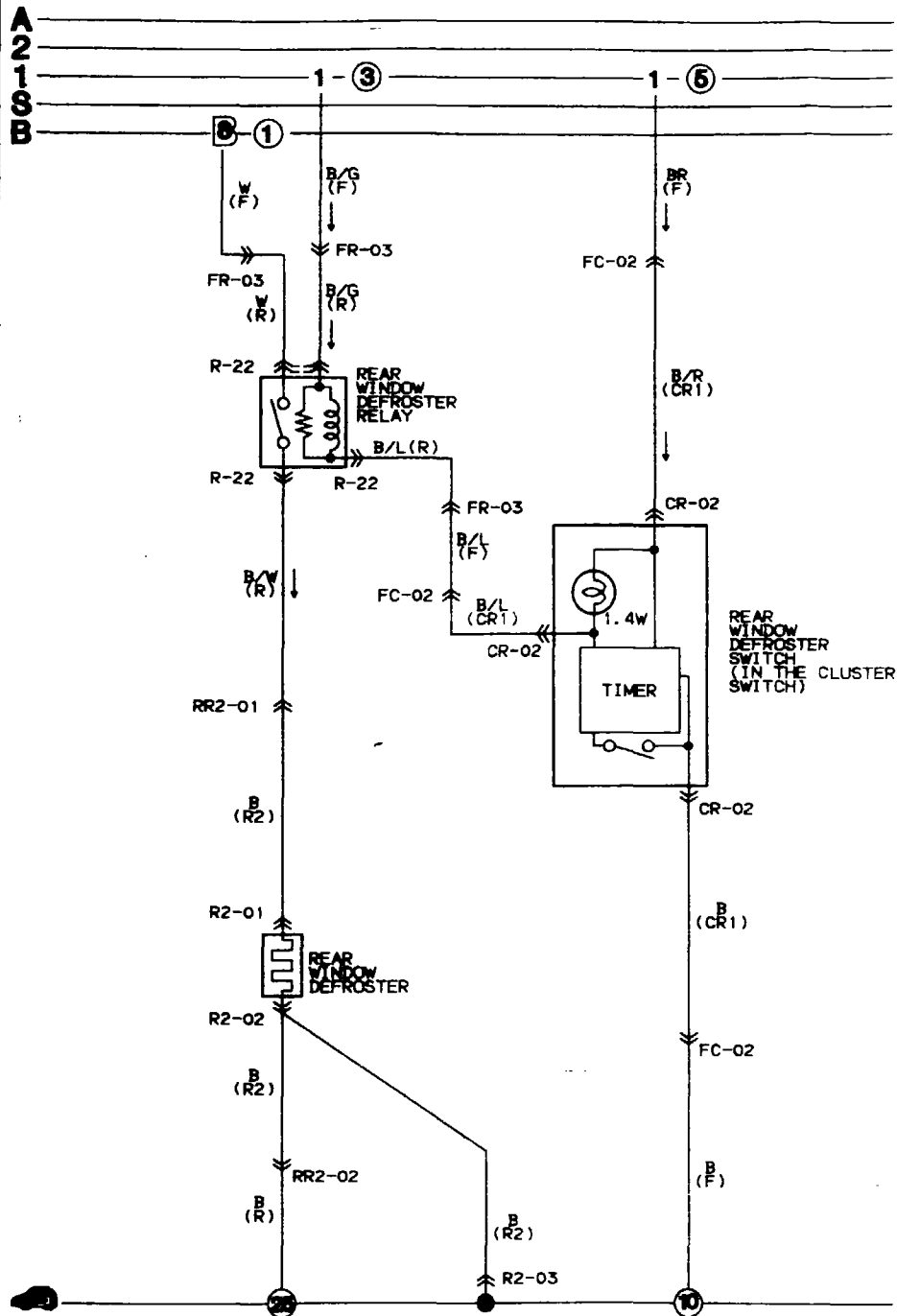

R-22 REAR WINDOW DEFROSTER RELAY(R) R2-01 REAR WINDOW DEFROSTER(R2) R2-02 REAR WINDOW DEFROSTER(R2)

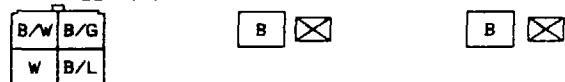

R2-03 GROUND(R2) RR2-01 CONNECTOR BETWEEN REAR(R) AND NO. 2 REAR(R2) HARNESS RR2-02 CONNECTOR BETWEEN REAR(R) AND NO. 2 REAR(R2) HARNESS

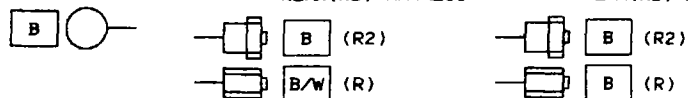

CR-02 REAR WINDOW DEFROSTER SWITCH(CR1)(IN THE CLUSTER SWITCH)

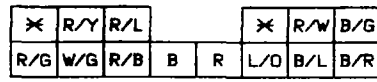

FC-02 CONNECTOR BETWEEN FRONT(F) AND CLUSTER SWITCH(CR1) HARNESS(L.H.)

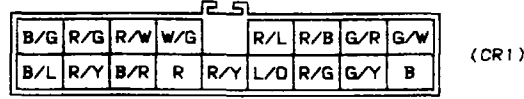
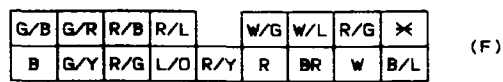

FR-03 CONNECTOR BETWEEN FRONT(F) AND REAR(R) HARNESS

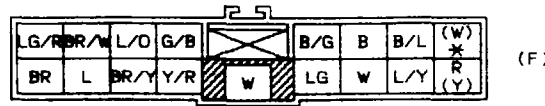

()... WITH A. B. S.

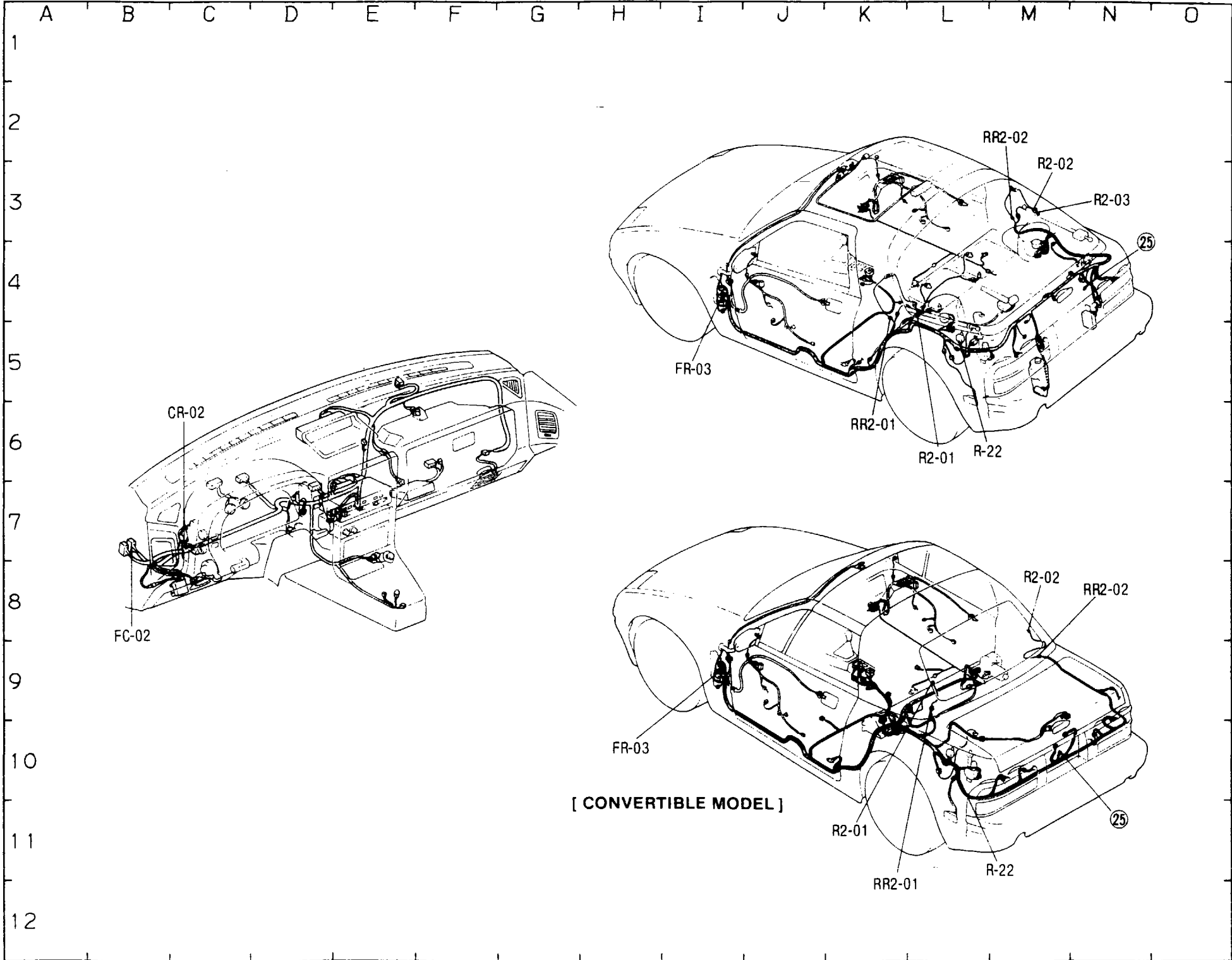

POWER WINDOW

A
2
1
B
S
B

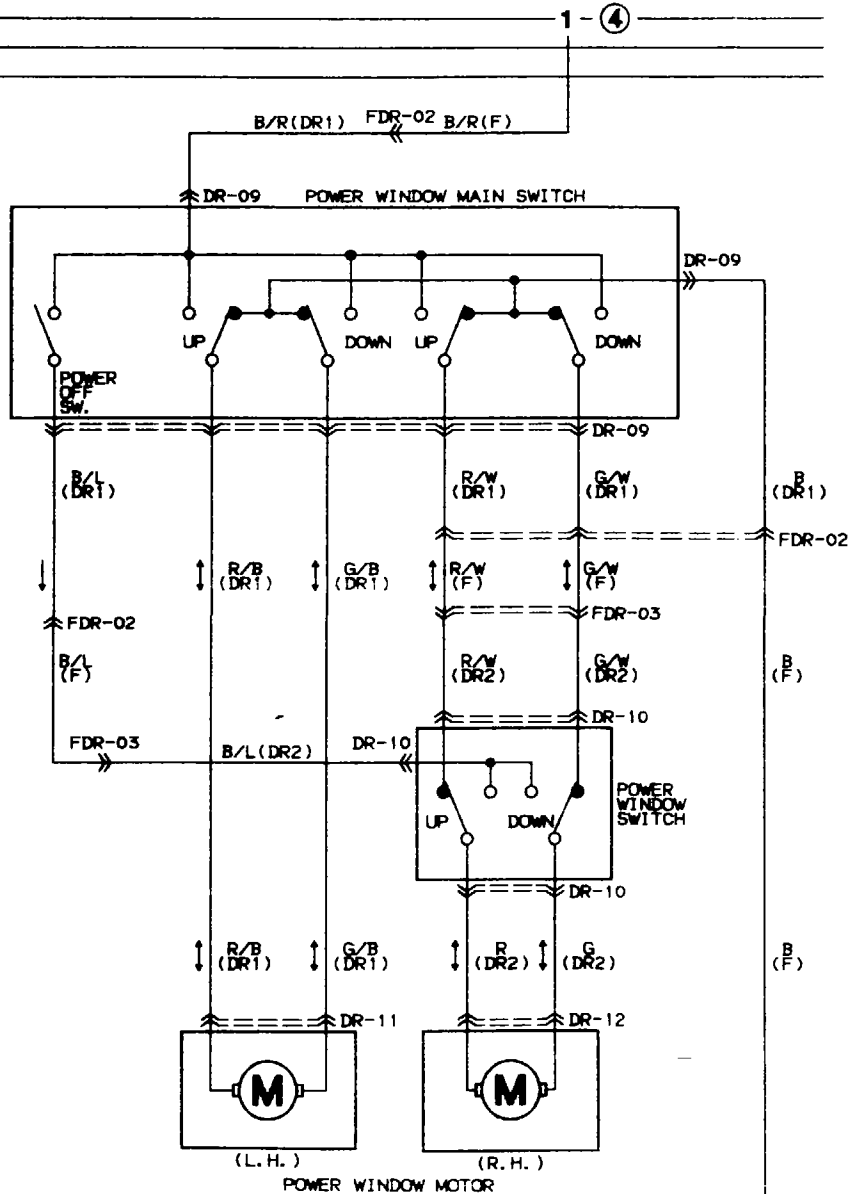

DR-09 POWER WINDOW MAIN SWITCH (DR1)

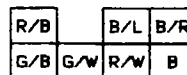

DR-10 POWER WINDOW SWITCH (DR2)



DR-11 POWER WINDOW MOTOR (L.H.) (DR1)



DR-12 POWER WINDOW MOTOR (R.H.) (DR2)



FDR-02 CONNECTOR BETWEEN FRONT (F) AND NO. 1 DOOR (DR1) HARNESS

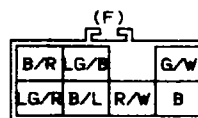

FDR-03 CONNECTOR BETWEEN FRONT (F) AND NO. 2 DOOR (DR2) HARNESS

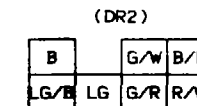
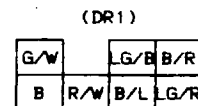
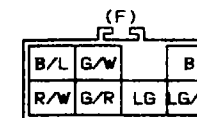

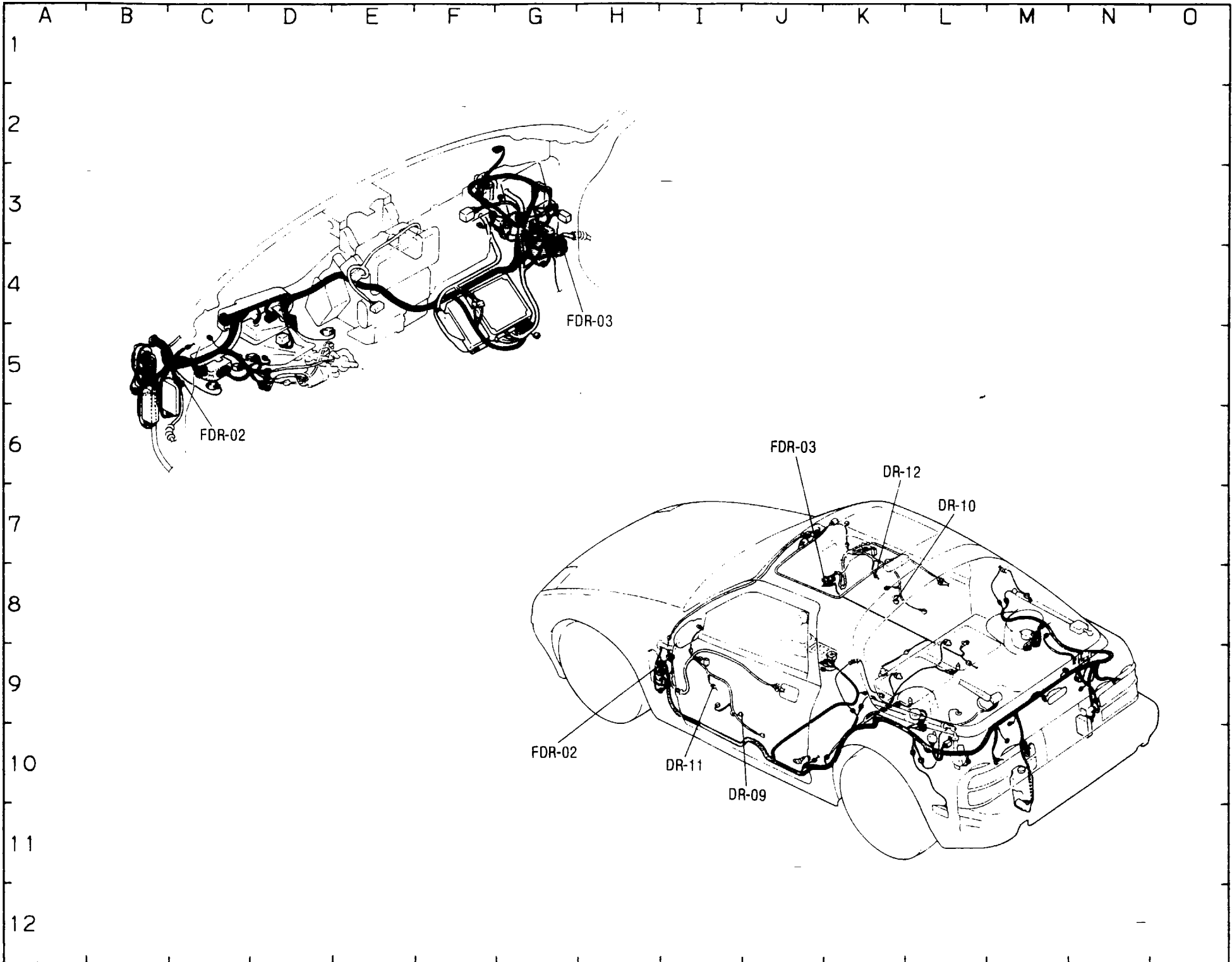

■ REMOTE CONTROL MIRROR
■ CIGARETTE LIGHTER

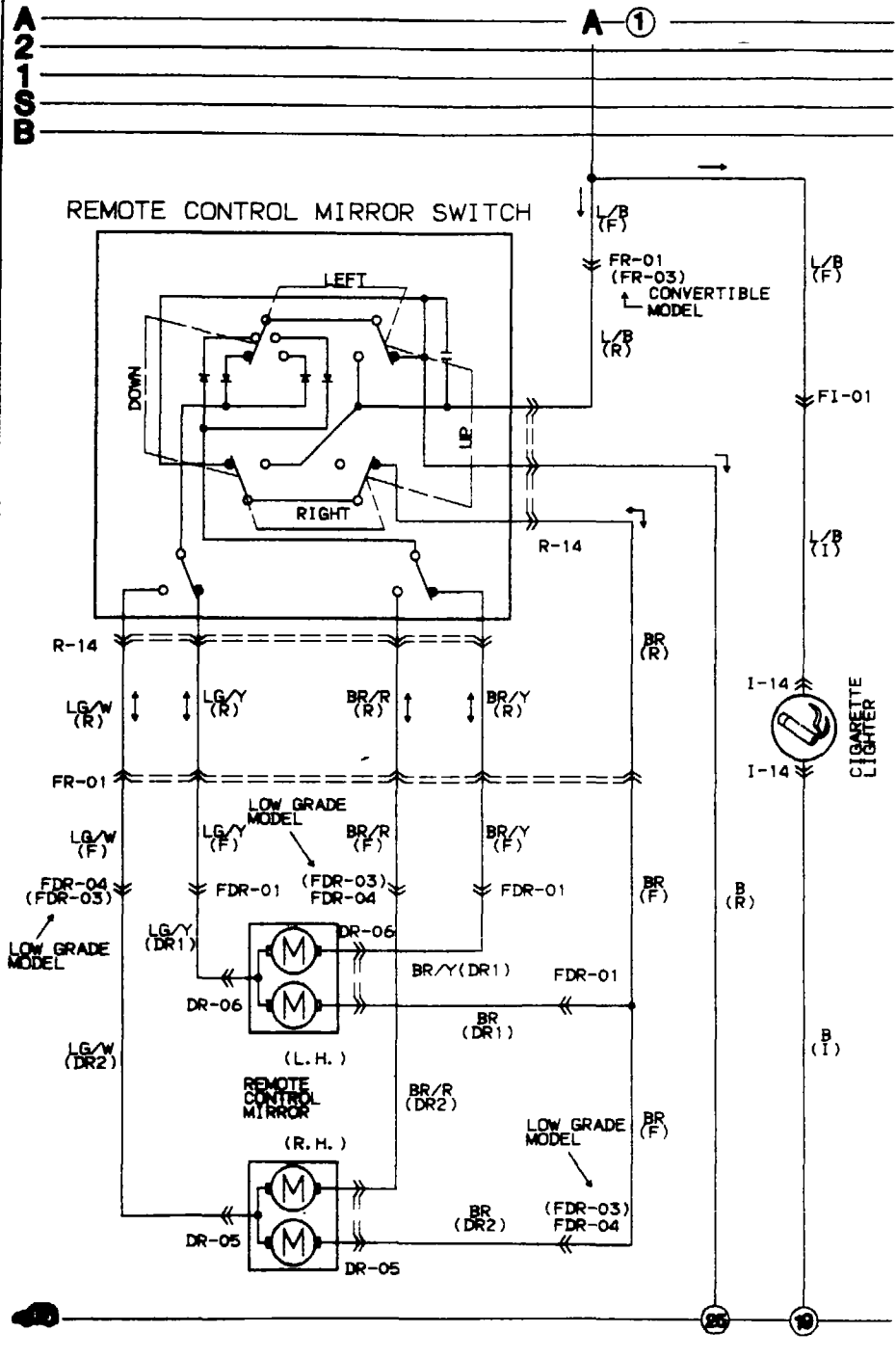

I-14 CIGARETTE LIGHTER(I)

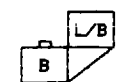

R-14 REMOTE CONTROL MIRROR SWITCH(R)



DR-05 REMOTE CONTROL MIRROR(R. H.)

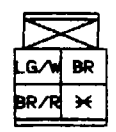

DR-06 REMOTE CONTROL MIRROR(L. H.)

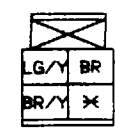

FI-01 CONNECTOR BETWEEN FRONT(F) AND INSTRUMENT PANEL(I) HARNESS

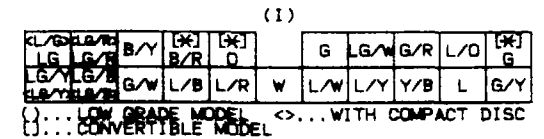
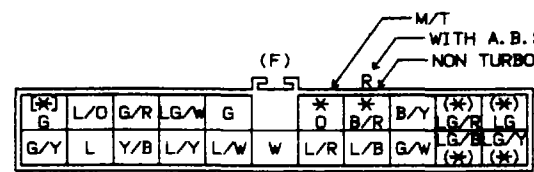

FR-01 CONNECTOR BETWEEN FRONT(F) AND REAR(R) HARNESS

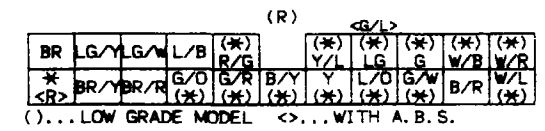
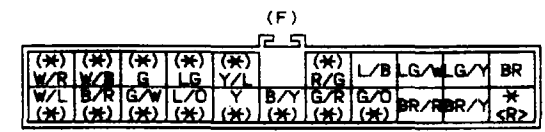

FDR-01 CONNECTOR BETWEEN FRONT(F) AND NO. 1 DOOR(DR1) HARNESS(L. H.)

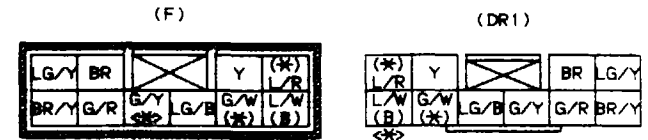

FDR-03 CONNECTOR BETWEEN FRONT(F) AND NO. 2 DOOR(DR2) HARNESS

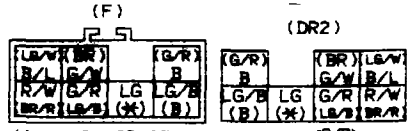

FDR-04 CONNECTOR BETWEEN FRONT(F) AND NO. 2 DOOR(DR2) HARNESS(R. H.)

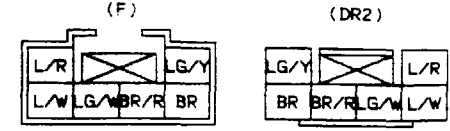

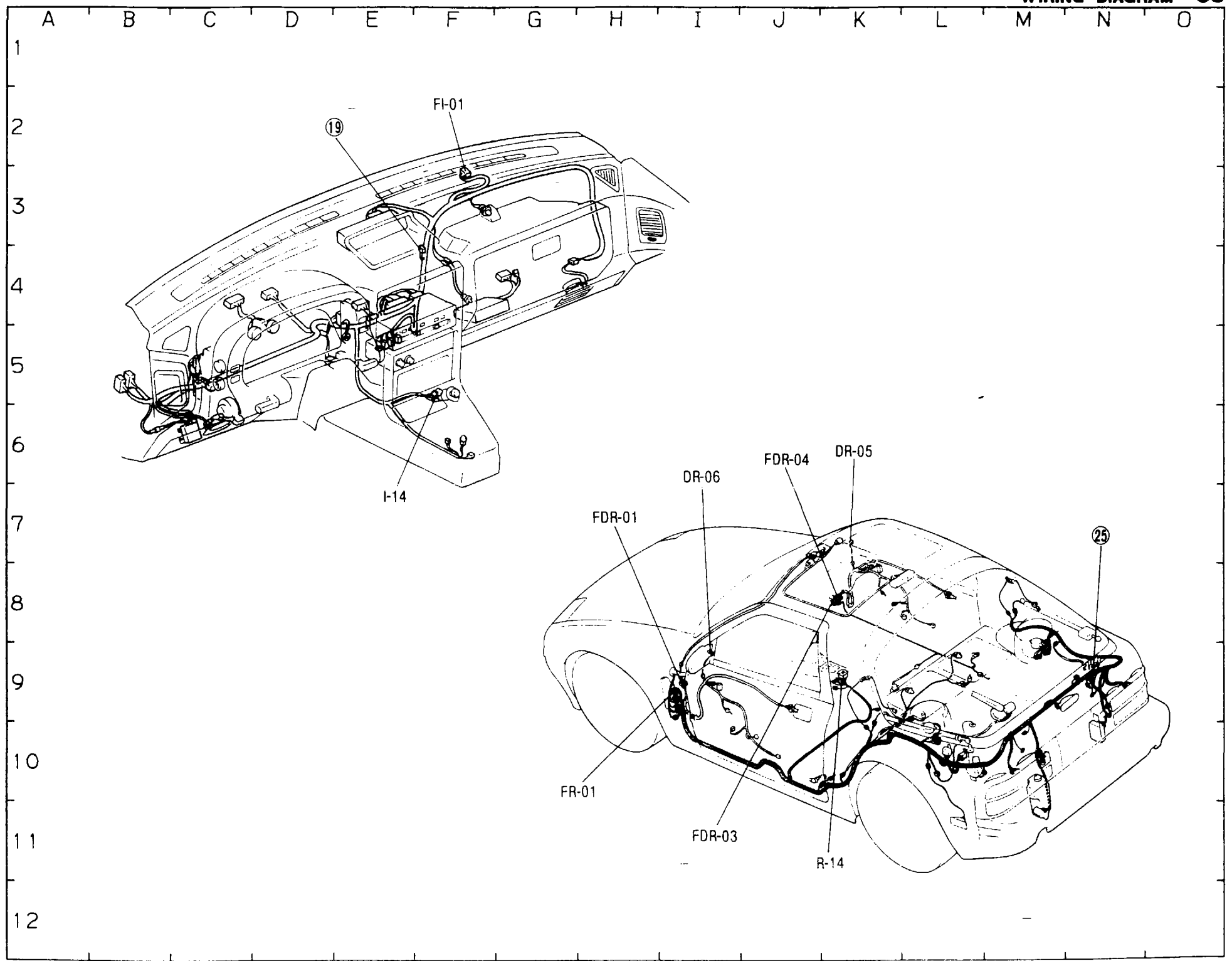

CRUISE CONTROL SYSTEM

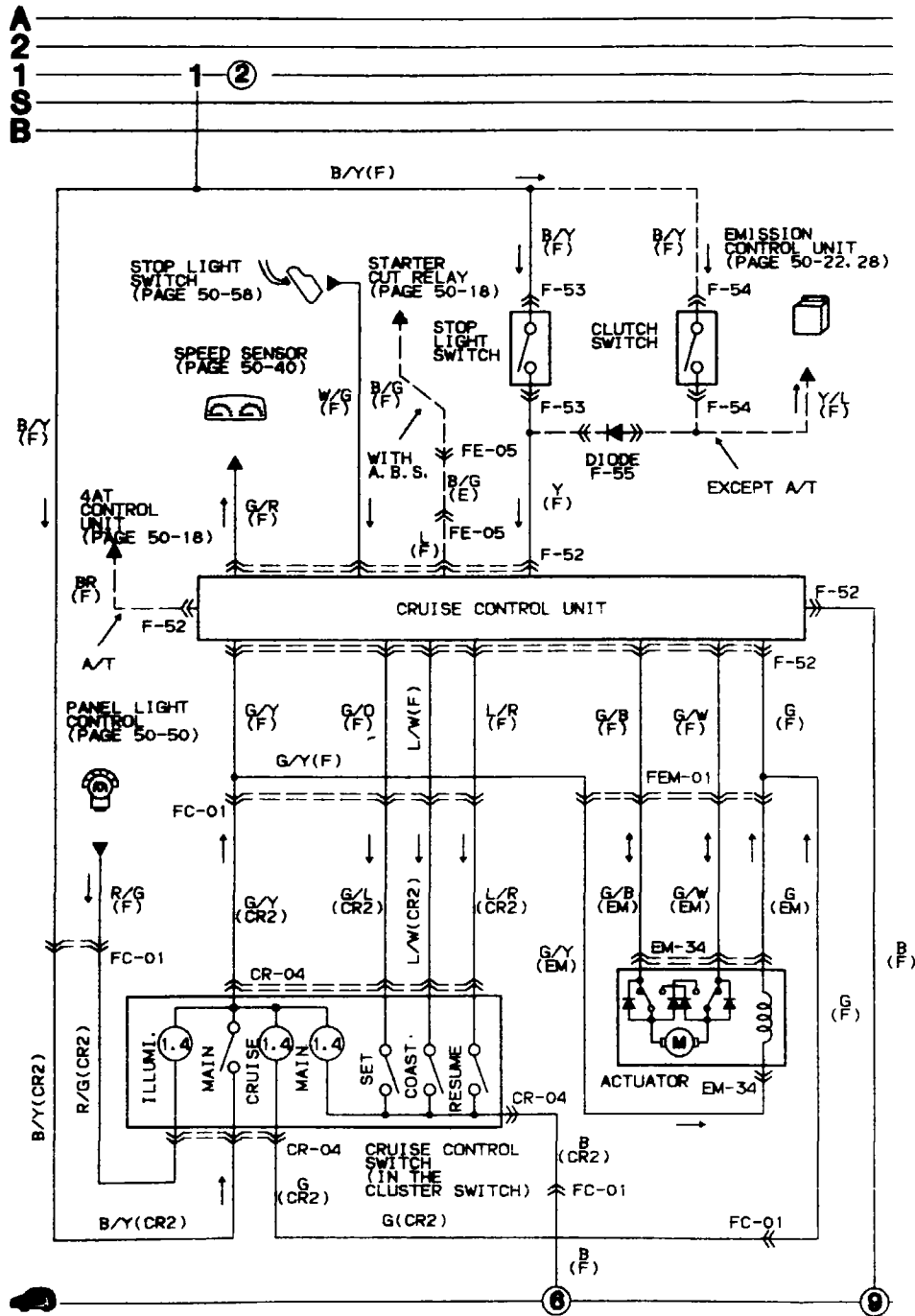

F-52 CRUISE CONTROL UNIT(F)

B	L/W	G/D		Y	G	G/W
W/G	* (BR)	L/R	G/R	G/Y	* (B/G)	G/B

 <L>

()... A/T <>... NON TURBO WITH A. B. S.

F-53 STOP LIGHT SWITCH(F)

B/Y
Y

F-54 CLUTCH SWITCH(F) F-55 DIODE(F)

B/Y
Y/L



Y/L
Y

G/Y	G
G/W	G/B

EM-34 ACTUATOR(EM)

CR-04 CRUISE CONTROL SWITCH (IN THE CLUSTER SWITCH) (CR2)

G	*		* G/L
G/Y	B/Y	R/G	L/W

FE-05 CONNECTOR BETWEEN FRONT(F) AND ENGINE(E) HARNESS

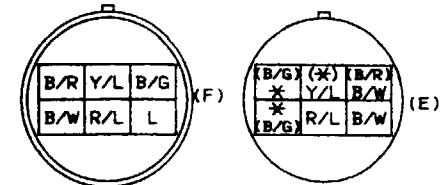

()... A/T

FEM-01 CONNECTOR BETWEEN FRONT(F) AND EMISSION(EM) HARNESS

(F)						(EM)							
L/W	L/R	L/W	B/R	B/R	G	G/Y	G/Y	G	B/R	BR	BR/R	L/R	L/W
L	L/Y	L/L	B/B	B	G/B	G/W	G/W	G/B	B	* (Y/W)	* (G/B)	L/Y	L

()... TURBO <>... NON TURBO WITH A/T OR A. B. S.

FC-01 CONNECTOR BETWEEN FRONT(F) AND CLUSTER SWITCH(CR2) HARNESS

(F)												
L/D	L/W	L	* (R)	R/G		LG	B/Y	L/W	G/Y	B		
L/R	L/Y	LB	LG/Y	*	*	G/W	L/R	G/D	G	*		

<R/W> <B/Y>

(CR2)												
B	G/Y	L/W	B/Y	G/D		R/G	B/R	L	L/W	L/D		
*	G	G/L	L/R	G/W	*	*	L/G	L/B	L/Y	L/R		

()... LOW GRADE MODEL <>... CONVERTIBLE MODEL

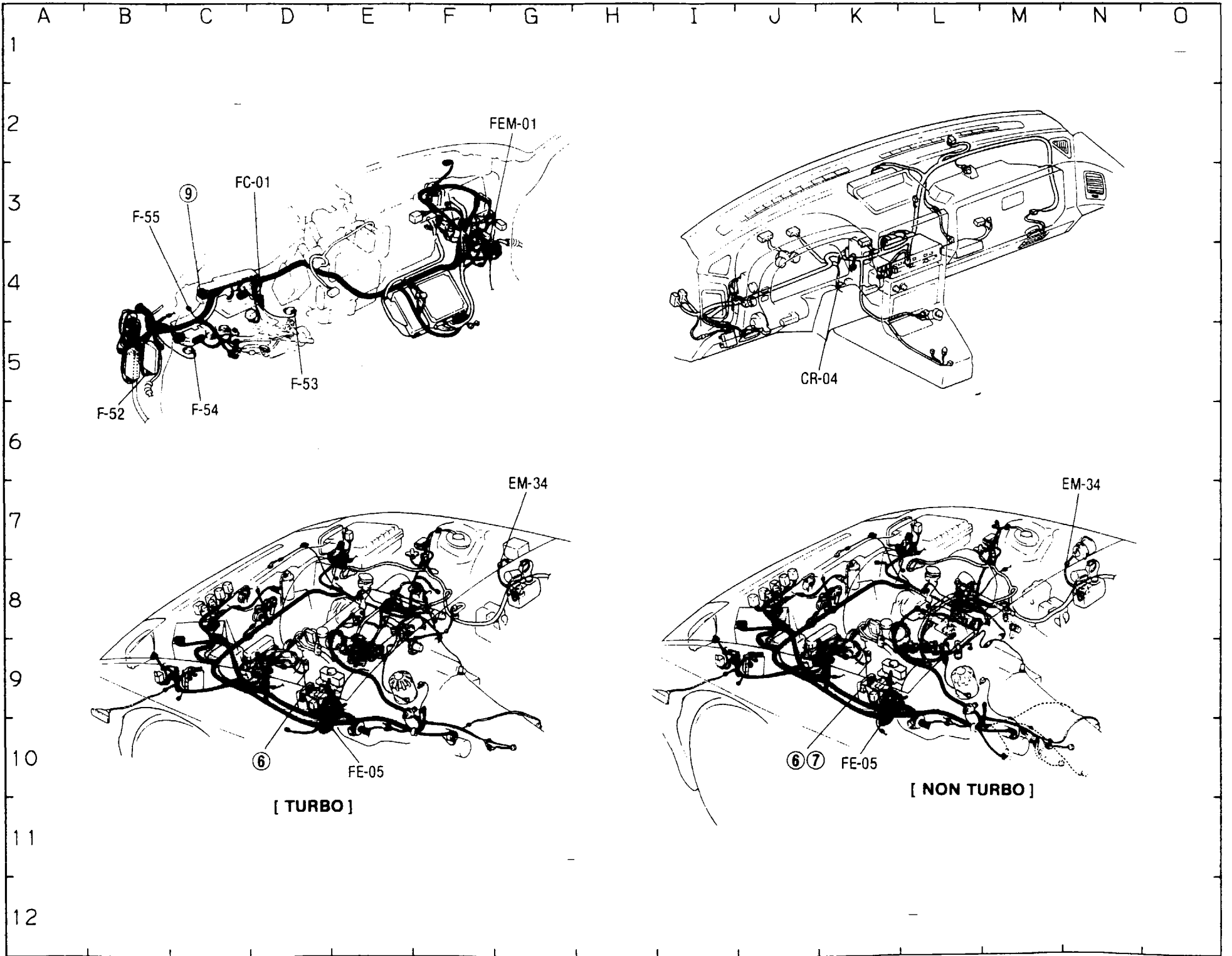

THEFT-DETERRENT SYSTEM

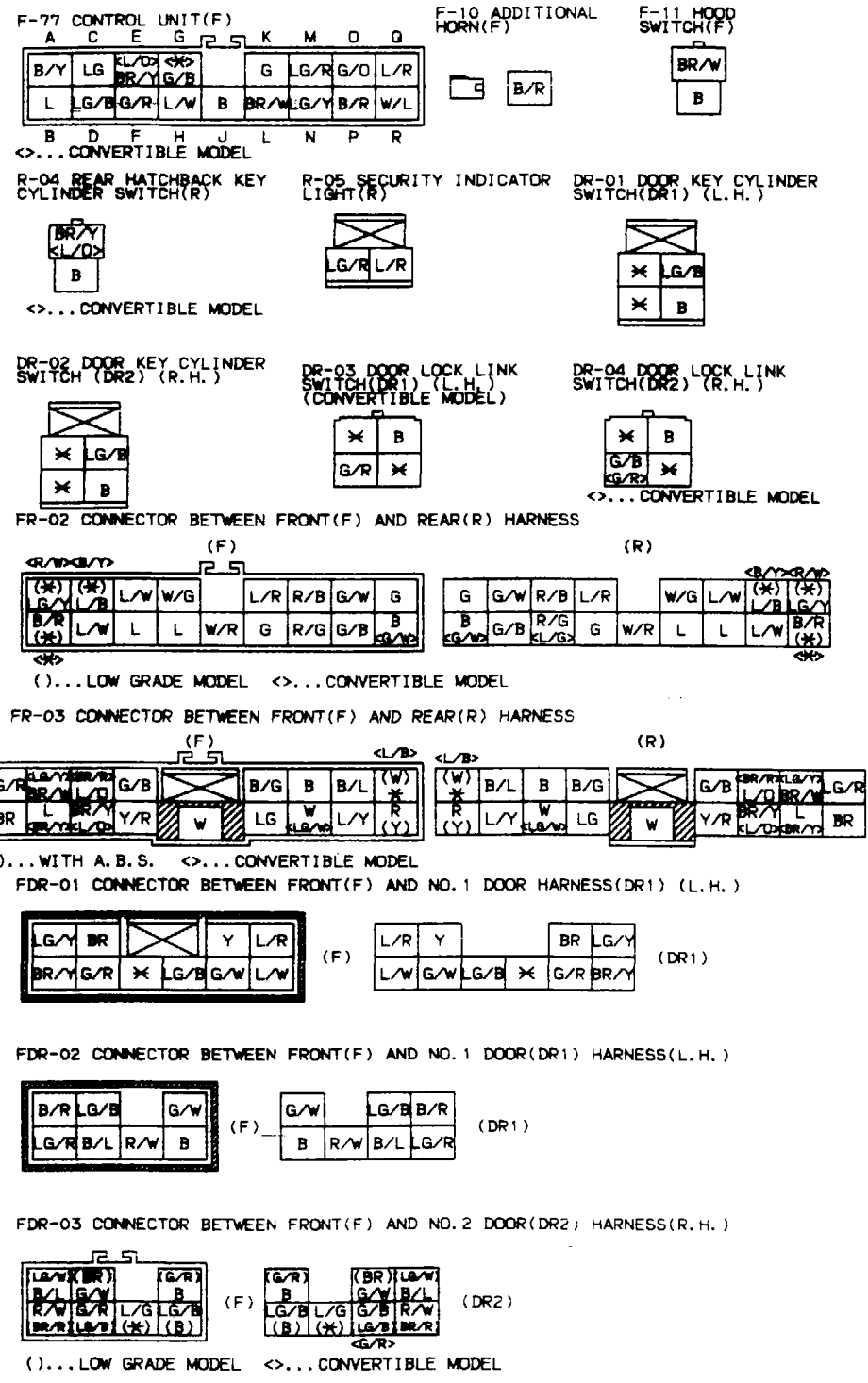
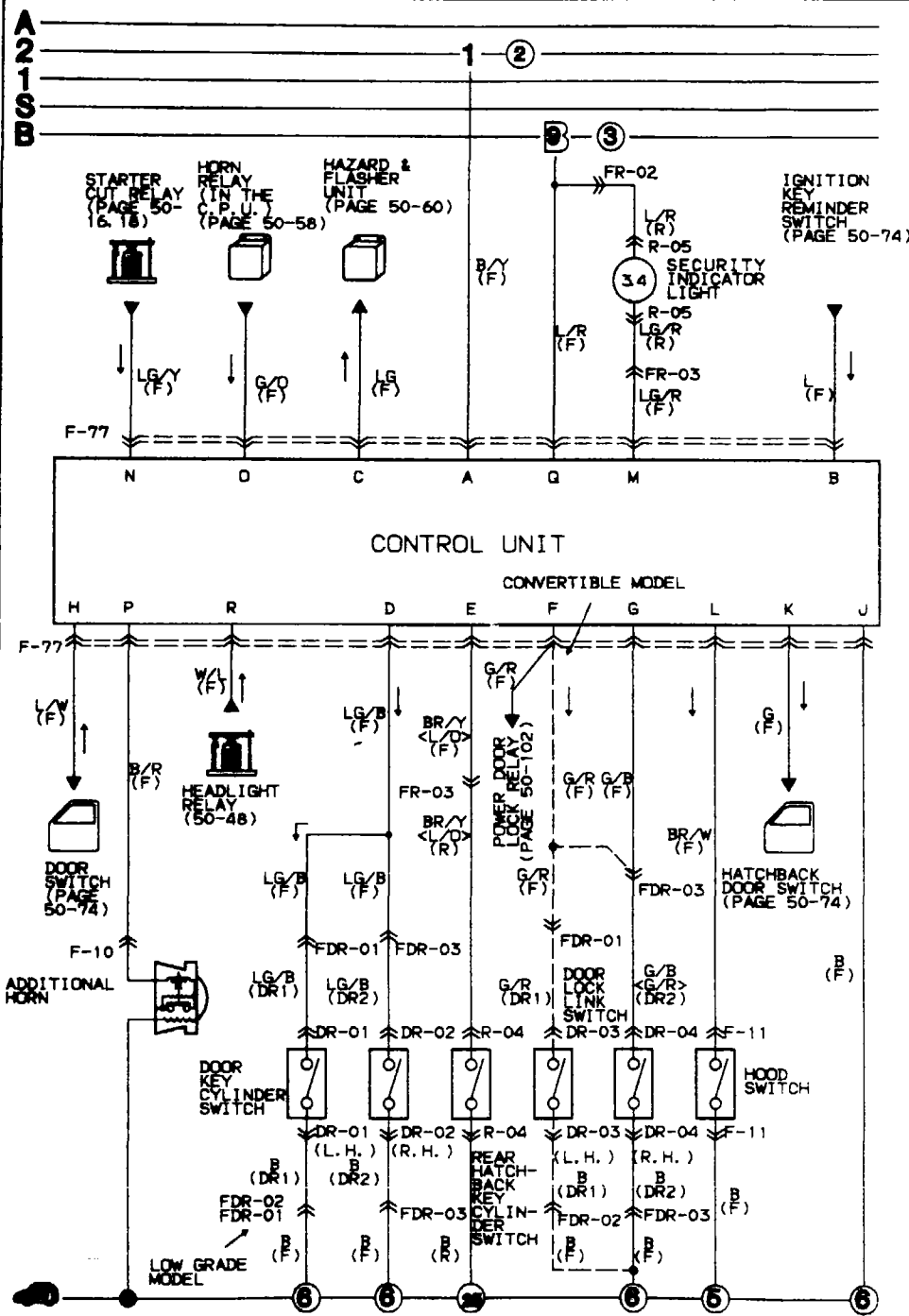

A B C D E F G H I J K L M N O

1
2
3
4
5
6
7
8
9
10
11
12

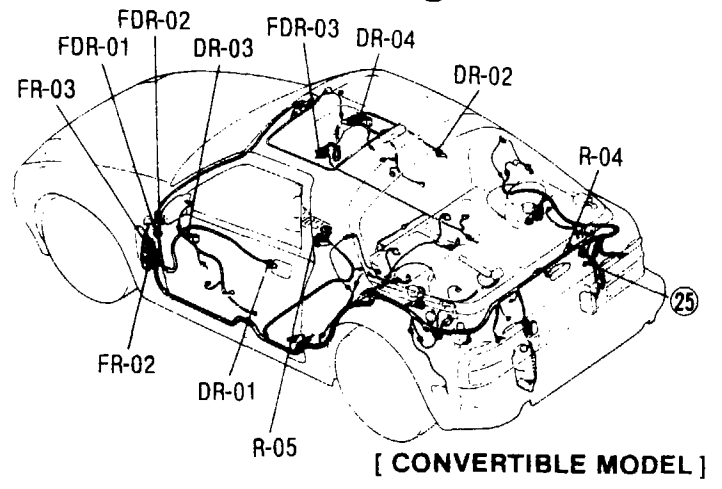
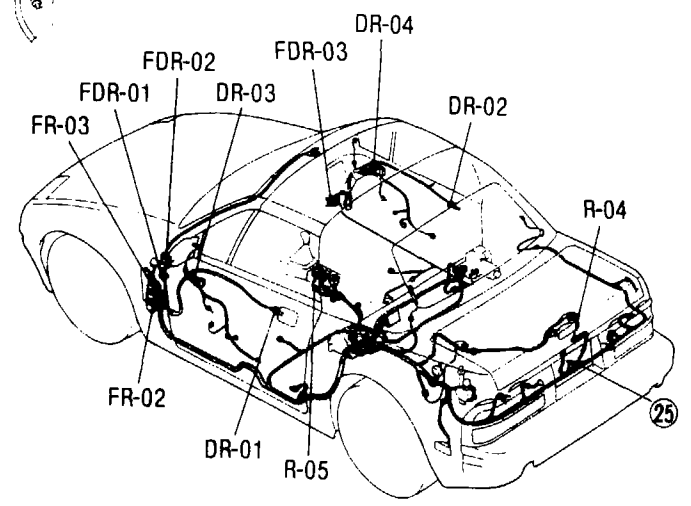
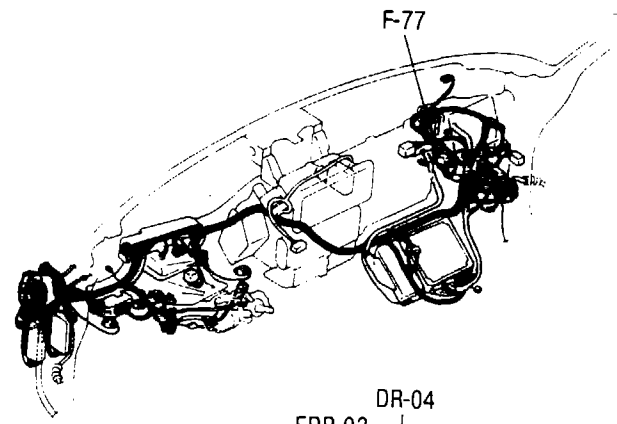
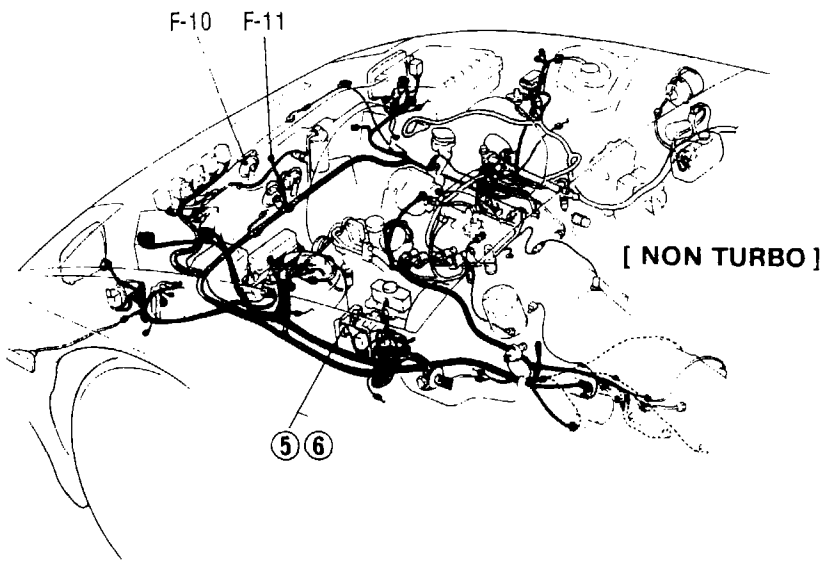

▪ AUDIO SYSTEM (WITH COMPACT DISC) ▪ POWER ANTENNA

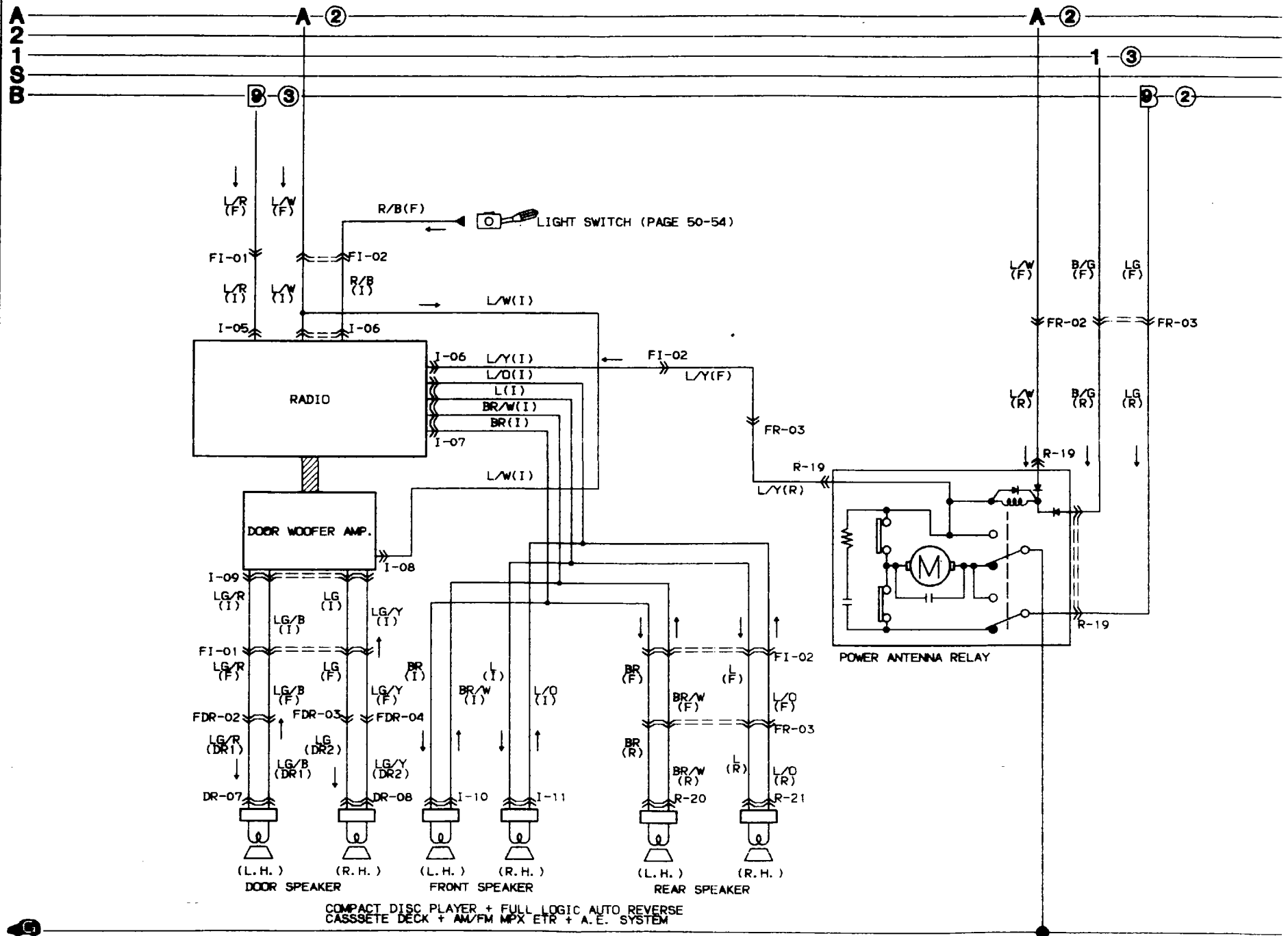

I-05 RADIO(I)



I-06 RADIO(I)



I-07 RADIO(I)

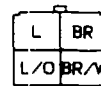

I-08 DOOR WOOFER AMP. (I)



I-09 DOOR WOOFER AMP. (I)

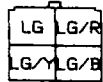

I-10 FRONT SPEAKER(L.H.)(R)



I-11 FRONT SPEAKER(R.H.)(I)



DR-07 DOOR SPEAKER (L.H.)(DR1)

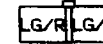

DR-08 DOOR SPEAKER(R.H.)(DR2)

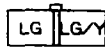

R-19 POWER ANTENNA RELAY(R)



R-20 REAR SPEAKER(L.H.)(R)



R-21 REAR SPEAKER(R.H.)(R)



FI-01 CONNECTOR BETWEEN FRONT(F) AND INSTRUMENT PANEL(I) HARNESS

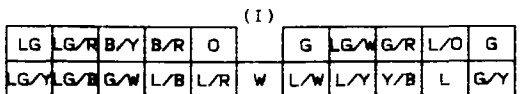
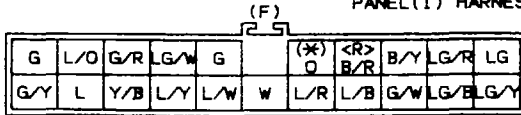

()...TURBO < >...WITH A. B. S.

FI-02 CONNECTOR BETWEEN FRONT(F) AND INSTRUMENT PANEL(I) HARNESS

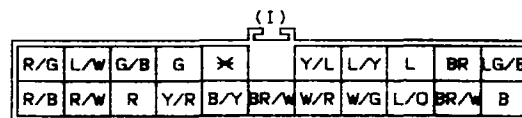
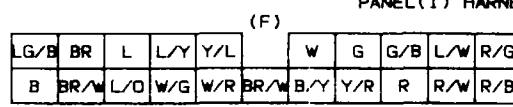

FR-02 CONNECTOR BETWEEN FRONT(F) AND REAR(R) HARNESS

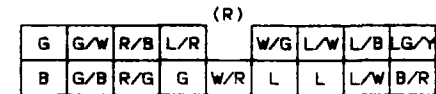
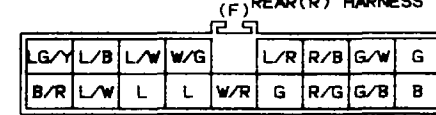

FR-03 CONNECTOR BETWEEN FRONT(F) AND REAR(R) HARNESS

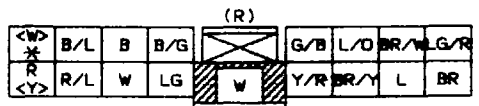
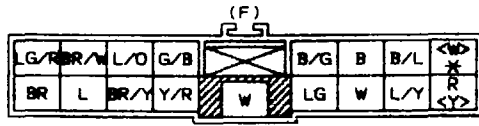

< >...WITH A. B. S.

FDR-02 CONNECTOR BETWEEN FRONT(F) AND NO. 1 DOOR HARNESS(DR1)(L.H.)

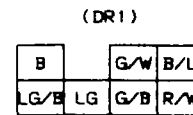
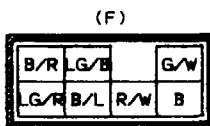

FDR-03 CONNECTOR BETWEEN FRONT(F) AND NO. 2 DOOR HARNESS(DR2)(R.H.)

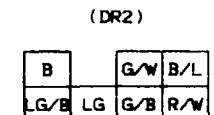
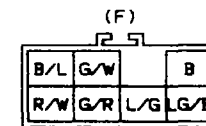

FDR-04 CONNECTOR BETWEEN FRONT(F) AND NO. 2 DOOR HARNESS(DR2)(R.H.)

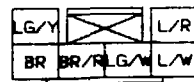
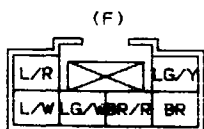

50 WIRING DIAGRAM

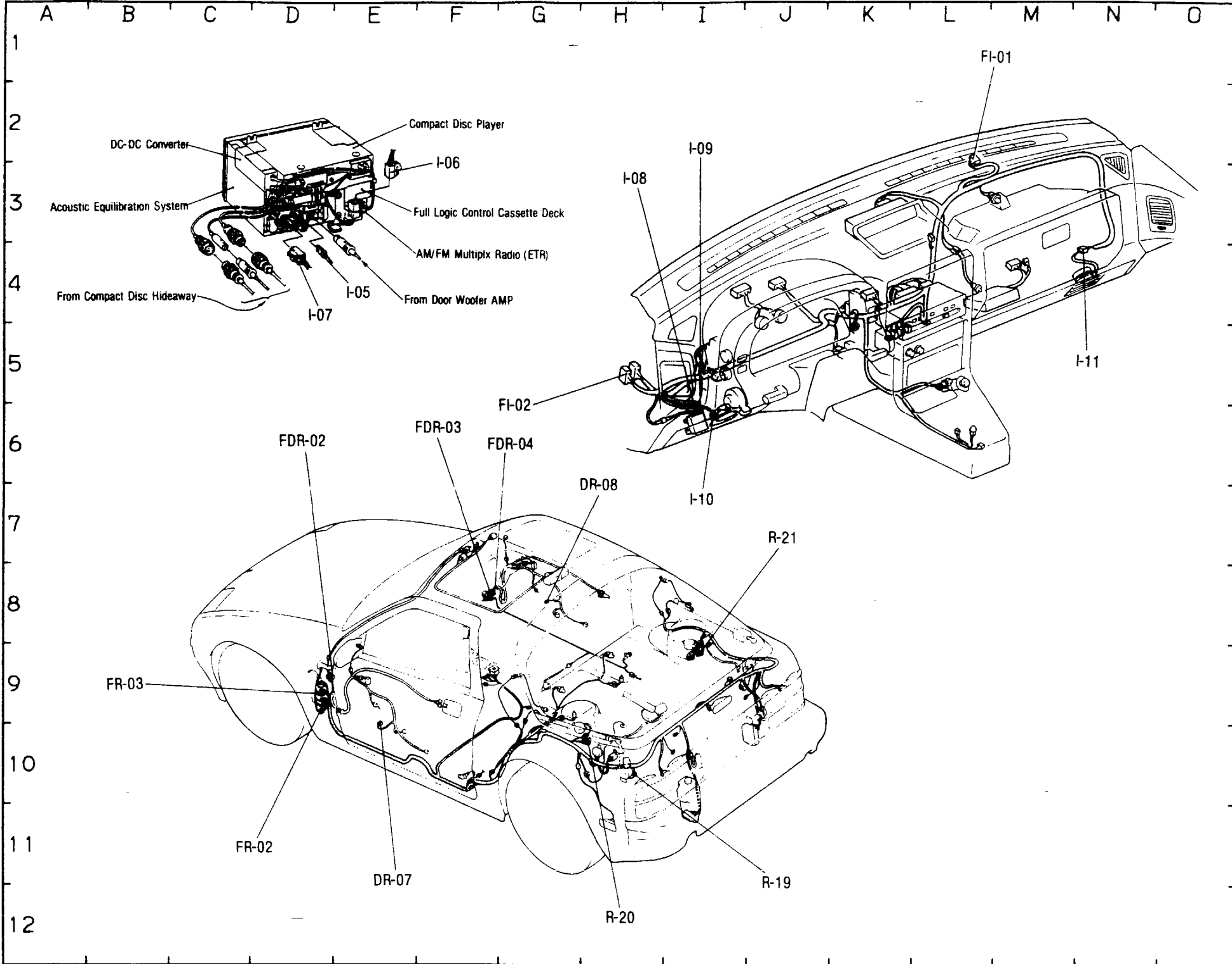

▪ AUDIO SYSTEM (HEADREST SPEAKER) ▪ POWER ANTENNA

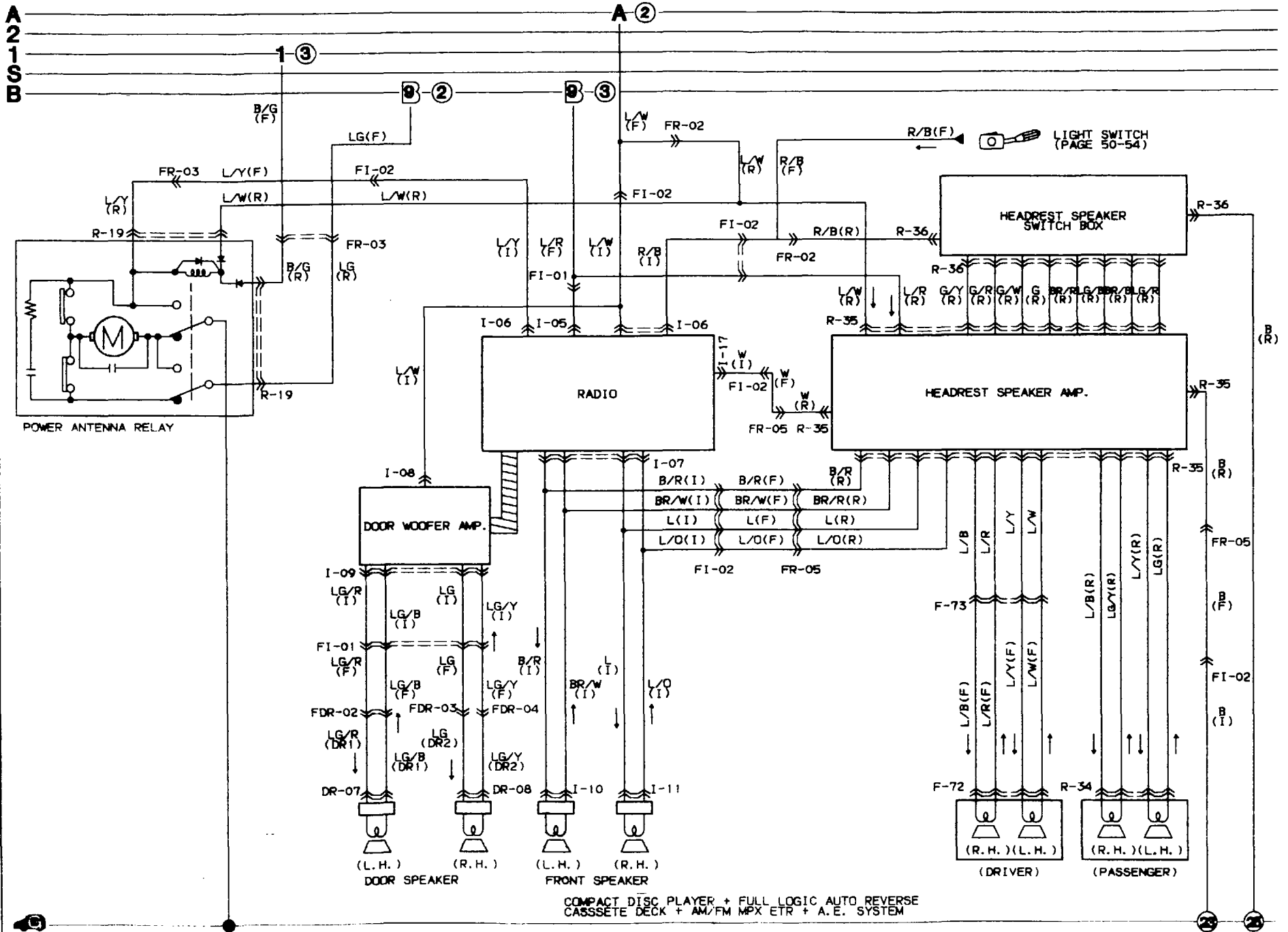

COMPACT DISC PLAYER + FULL LOGIC AUTO REVERSE
CASSETTE DECK + AM/FM MPX ETR + A.E. SYSTEM

I-05 RADIO(I)



I-06 RADIO(I)



I-07 RADIO(I)



I-08 DOOR WOOFER AMP. (I)



I-09 DOOR WOOFER AMP. (I)

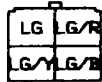

I-10 FRONT SPEAKER(L.H.)(R)



I-11 FRONT SPEAKER(R.H.)(I)



I-17 RADIO(I)



DR-07 DOOR SPEAKER (L.H.)(DR1)



DR-08 DOOR SPEAKER(R.H.)(DR2)

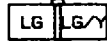

R-72 HEADREST SPEAKER (R.H.)(R)



F-73 CONNECTOR BETWEEN FRONT(F) AND SPEAKER HARNESS

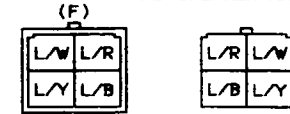

FI-01 CONNECTOR BETWEEN FRONT(F) AND INSTRUMENT PANEL(I) HARNESS

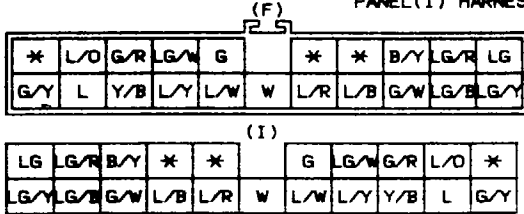

FI-02 CONNECTOR BETWEEN FRONT(F) AND INSTRUMENT PANEL(I) HARNESS

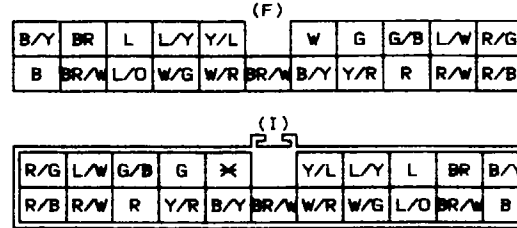

FR-02 CONNECTOR BETWEEN FRONT(F) AND REAR(R) HARNESS

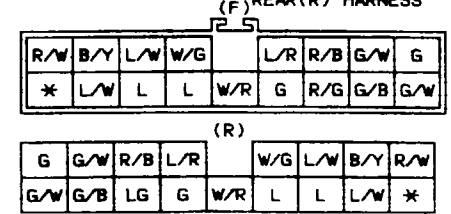

FR-03 CONNECTOR BETWEEN FRONT(F) AND REAR(R) HARNESS

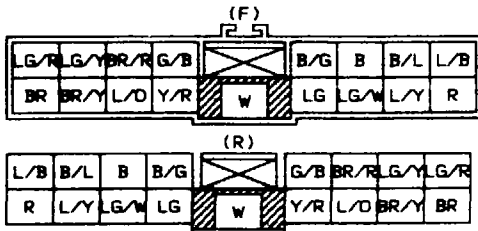

FR-05 CONNECTOR BETWEEN FRONT(F) AND REAR(R) HARNESS



FDR-02 CONNECTOR BETWEEN FRONT(F) AND NO. 1 DOOR HARNESS(DR1)(L.H.)



FDR-03 CONNECTOR BETWEEN FRONT(F) AND NO. 2 DOOR HARNESS(DR2)(R.H.)



FDR-04 CONNECTOR BETWEEN FRONT(F) AND NO. 2 DOOR HARNESS(DR2)(R.H.)

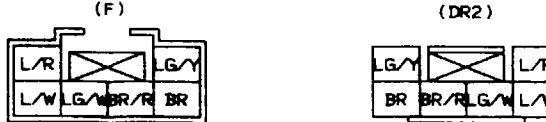

R-19 POWER ANTENNA RELAY(R)



R-72 HEADREST SPEAKER (R.H.)(R)



R-35 HEADREST SPEAKER AMP. (R)



R-36 HEADREST SPEAKER BOX(R)

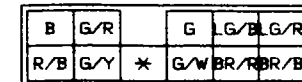

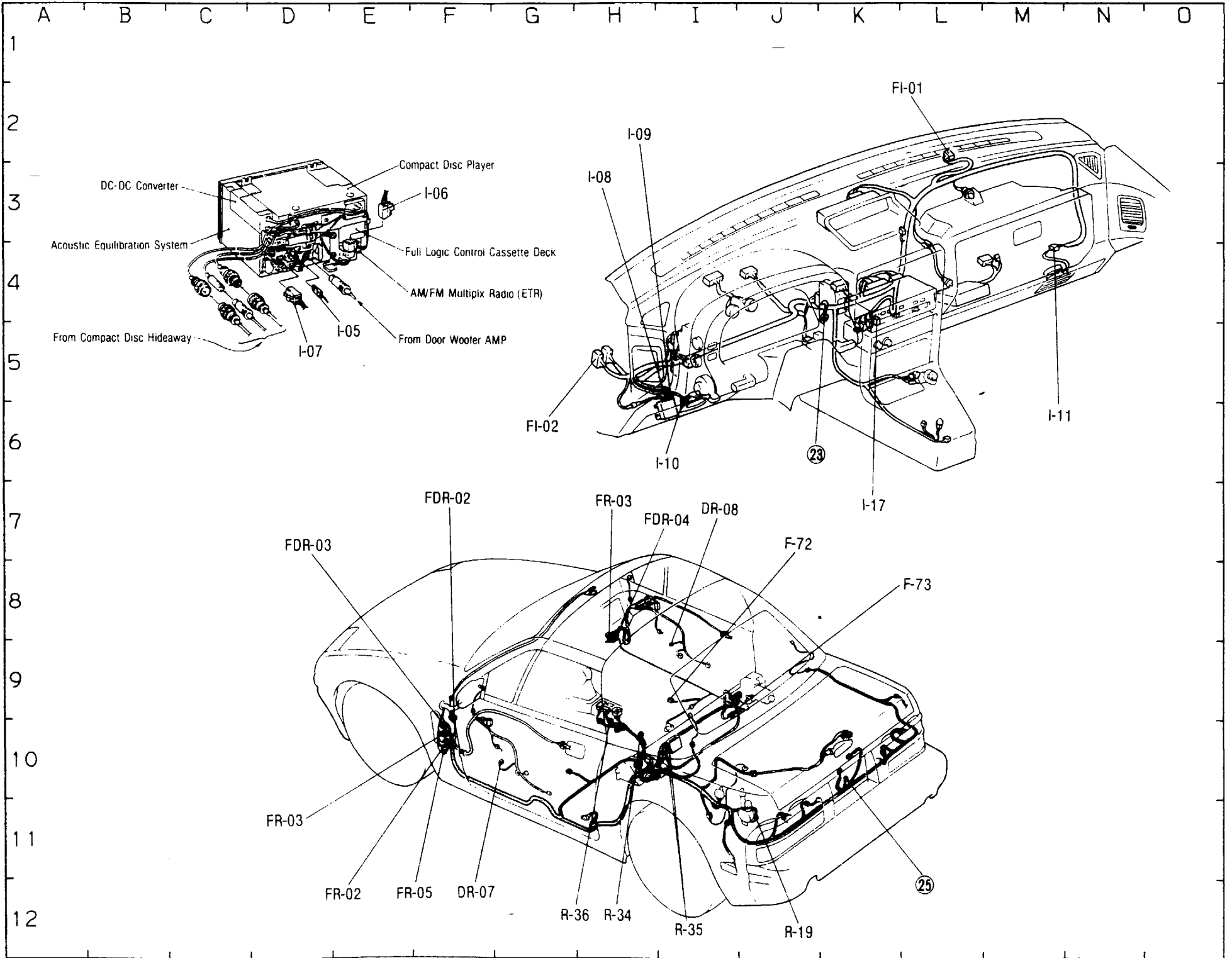

POWER DOOR LOCK SYSTEM

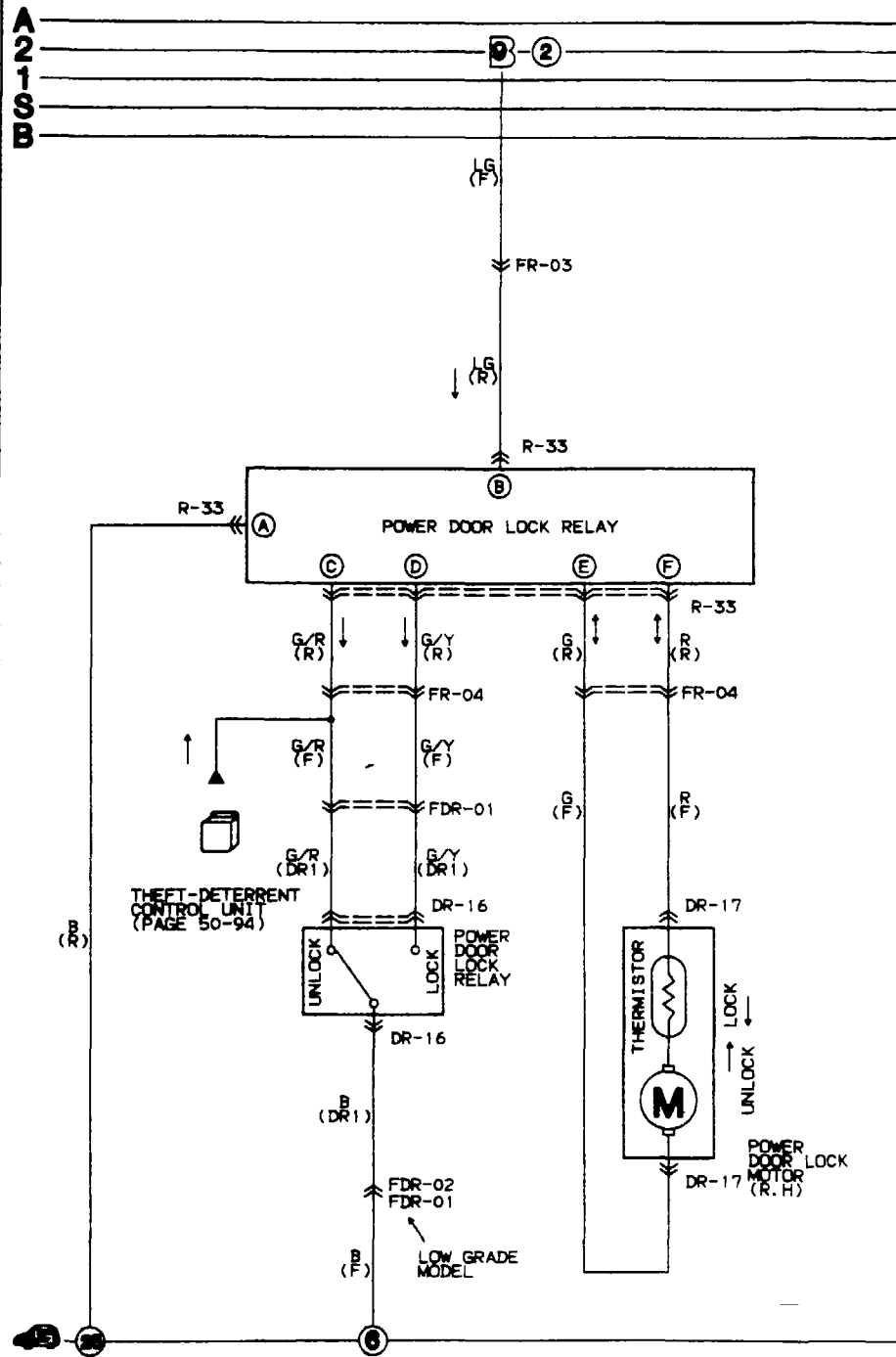

R-33 POWER DOOR LOCK RELAY(R)

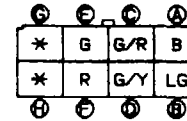

DR-16 POWER DOOR LOCK SWITCH(DR1)

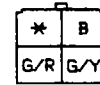

DR-17 POWER DOOR LOCK MOTOR(DR2)

FR-04 CONNECTOR BETWEEN FRONT(F) AND REAR(R) HARNESS

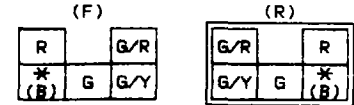

(...) WITH A. B. S.

FDR-01 CONNECTOR BETWEEN FRONT(F) AND DOOR NO. 1(DR1) HARNESS

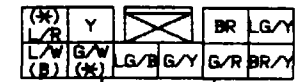

(...) LOW GRADE MODEL

FDR-02 CONNECTOR BETWEEN FRONT(F) AND NO. 1 DOOR(DR1) HARNESS

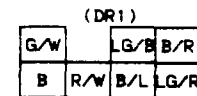
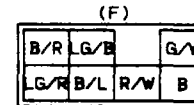

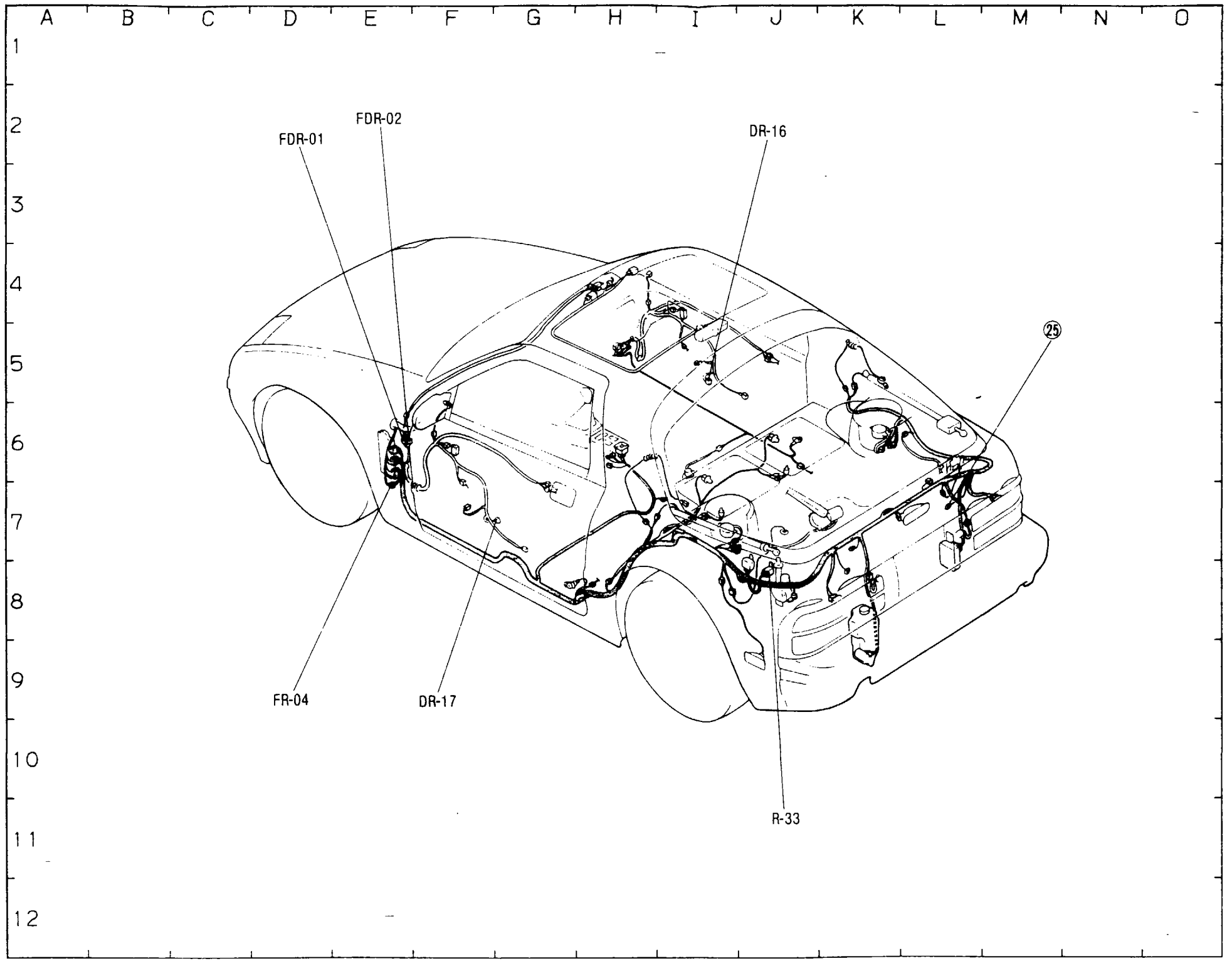

ANTI-LOCK BRAKE SYSTEM

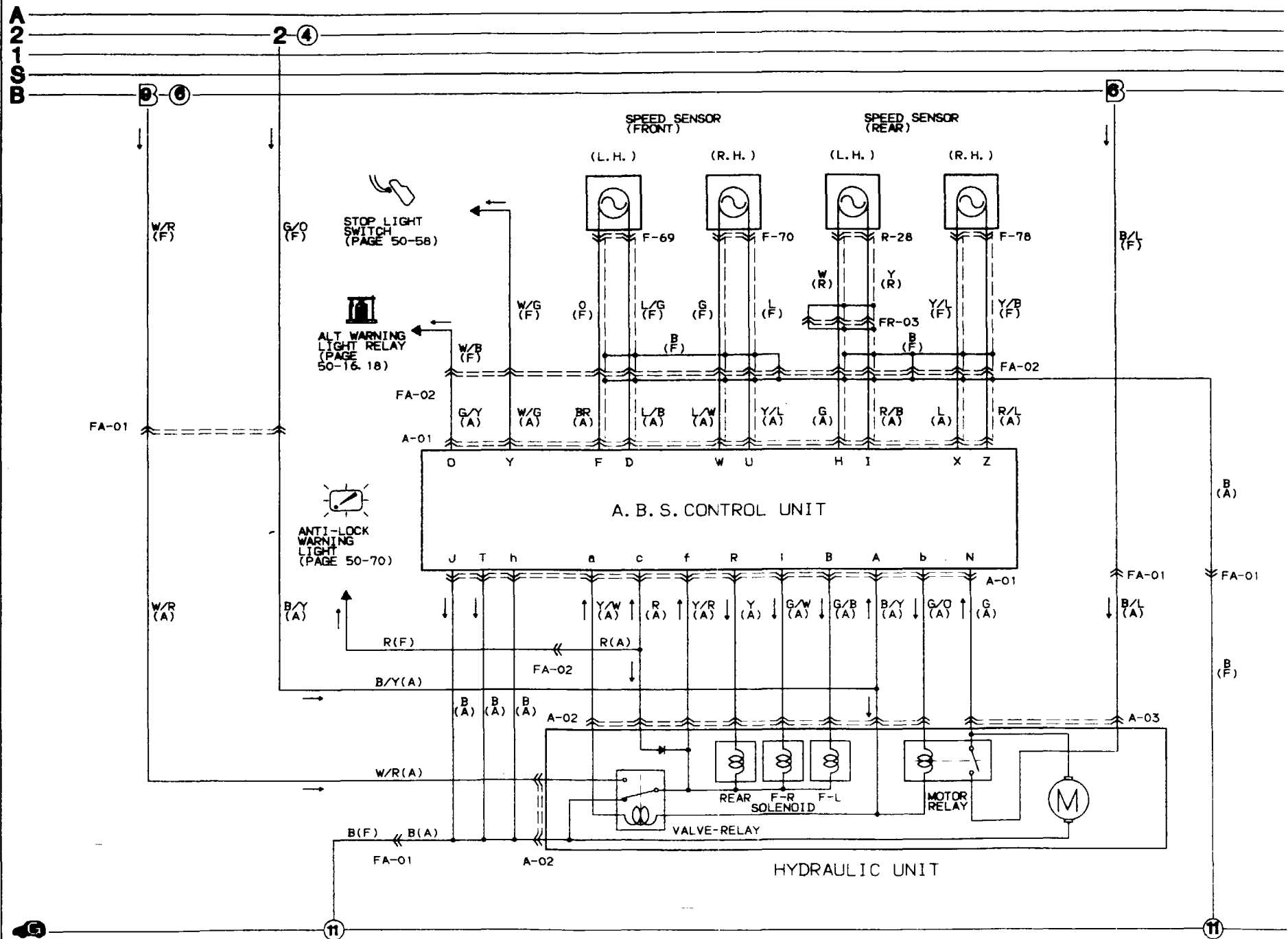

F-69 SPEED SENSOR(F.L.)(F)

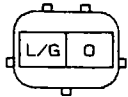

F-70 SPEED SENSOR(F.R.)(F)

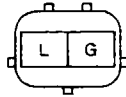

F-78 SPEED SENSOR(R.R.)(F)

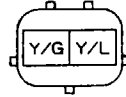

R-28 SPEED SENSOR(R.L)(R)

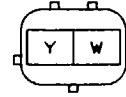

A-02 HYDRAULIC UNIT(A)

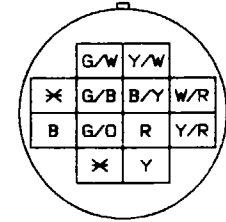

A-01 CONTROL UNIT(A)

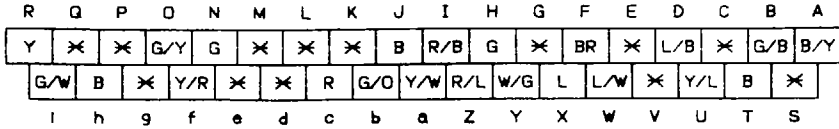

A-03 HYDRAULIC UNIT(A)



FA-01 CONNECTOR BETWEEN FRONT(F) AND A. B. S. (A) HARNESS

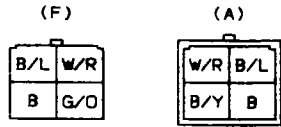

FA-02 CONNECTOR BETWEEN FRONT(F) AND A. B. S. (A) HARNESS

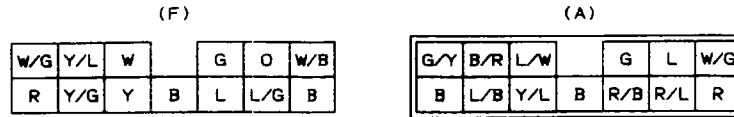

FR-03 CONNECTOR BETWEEN FRONT(F) AND REAR(R) HARNESS

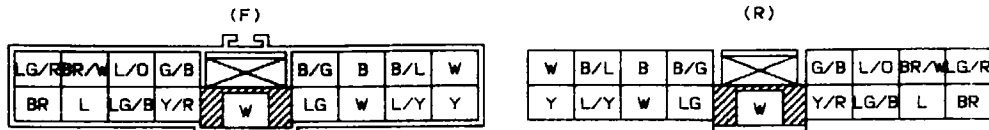

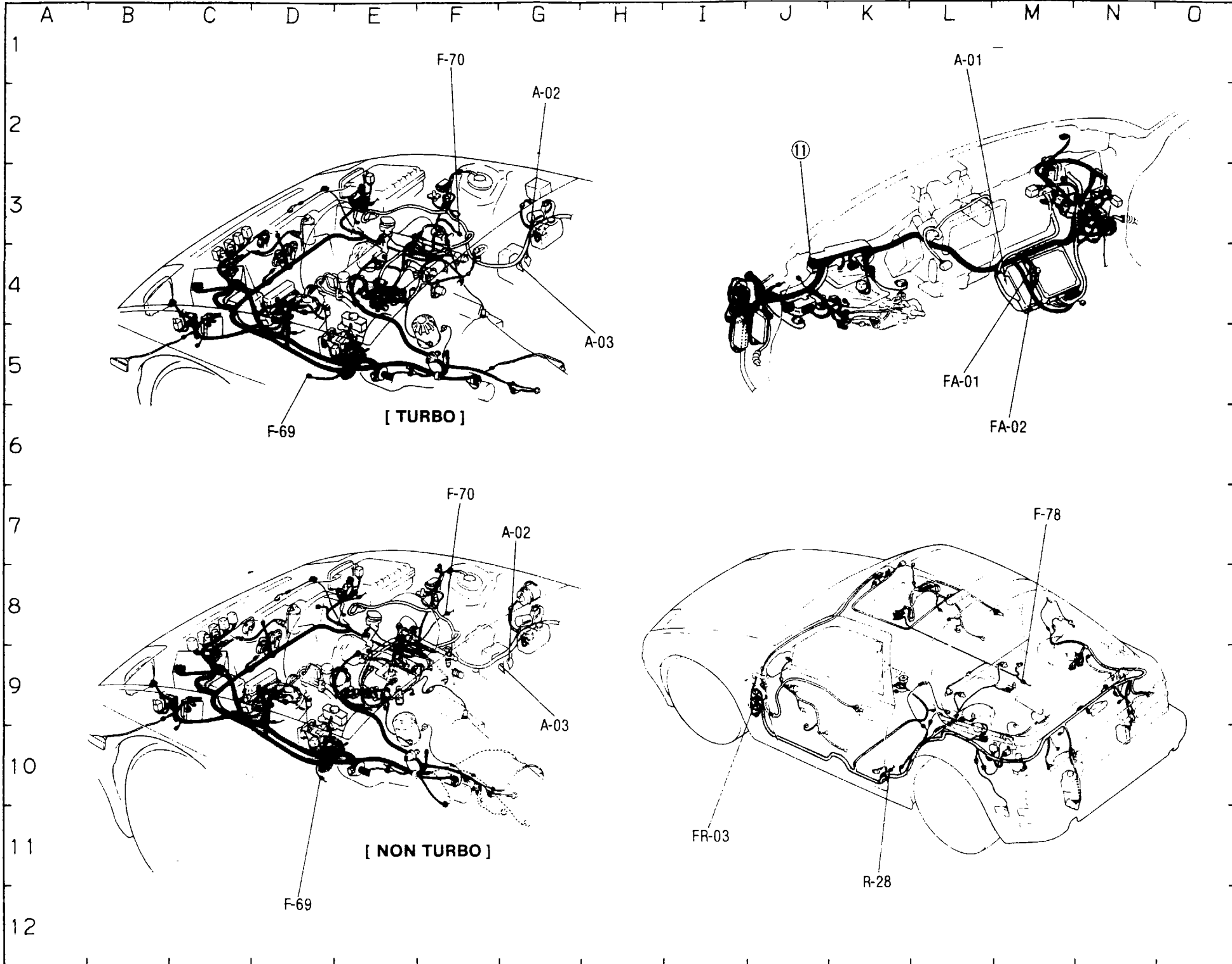

CONVERTIBLE TOP CONTROL SYSTEM

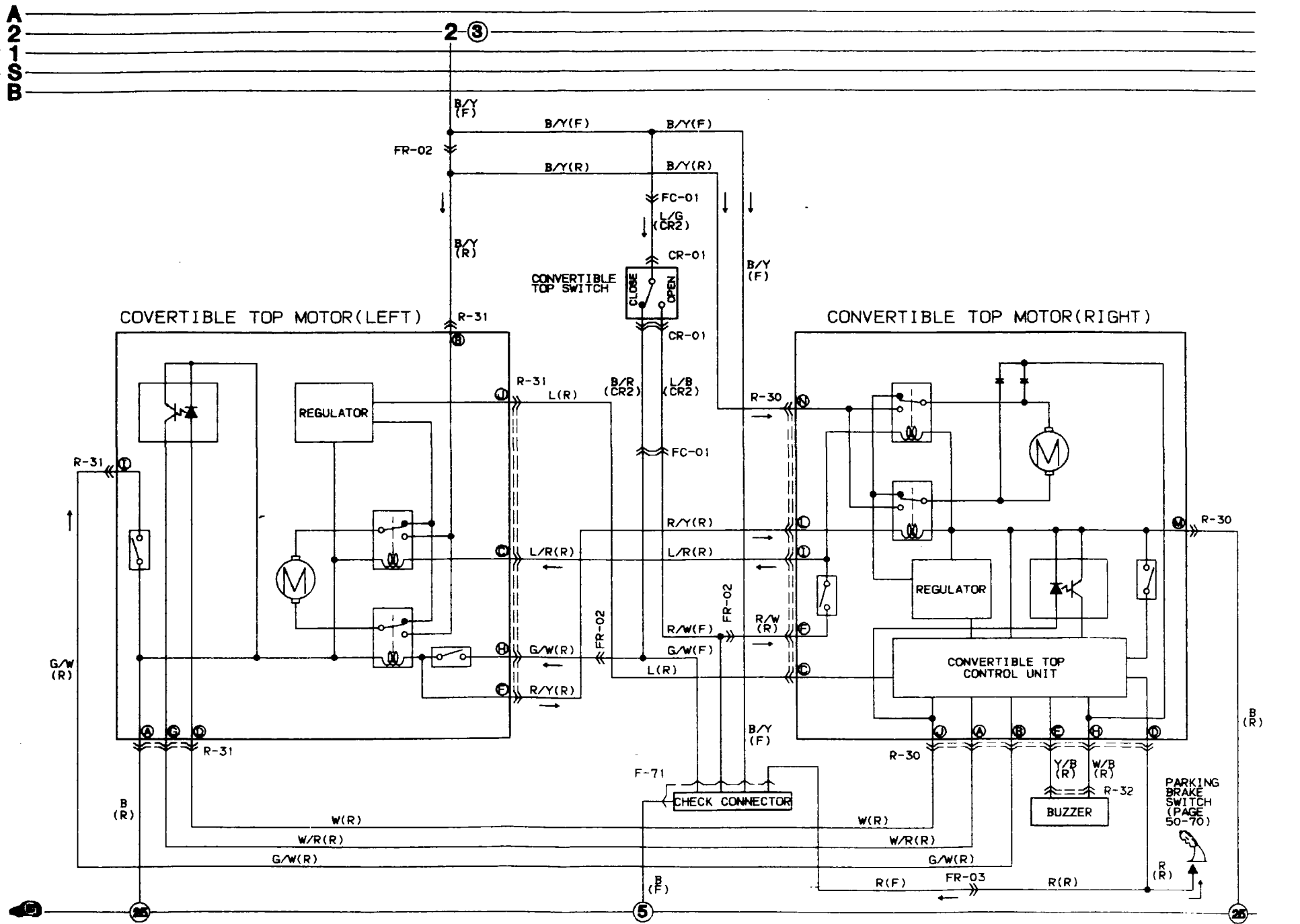

F-71 CHECK CONNECTOR(R) R-30 CONVERTIBLE TOP MOTOR(R.H.)(R) R-31 CONVERTIBLE TOP MOTOR(L.H.)(R) R-32 BUZZER(R)

R/W	B/Y	B
G/W	*	R

Ⓜ	Ⓝ	Ⓟ	Ⓧ	Ⓡ	Ⓛ
B	*	L/R	Y/B	L	W/R
B/Y	R/Y	W	W/B	R/W	R
Ⓜ	Ⓝ	Ⓟ	Ⓧ	Ⓡ	Ⓛ

Ⓟ	Ⓝ	Ⓡ	Ⓛ
G/W	W/R	L/R	B
L	G/W	R/Y	W
Ⓟ	Ⓝ	Ⓡ	Ⓛ

W/B	*	Y/B
-----	---	-----

CR-01 CONVERTIBLE TOP SWITCH(CR2)

G/O	R/G	L/G	L	L/B
B/R	G/W	B	L/R	L/W

FR-02 CONNECTOR BETWEEN FRONT(F) AND REAR(R) HARNESS

(F)	(R)						
R/W	B/Y	L/W	W/G	L/R	R/B	G/W	G
*	L/W	L	L	W/R	G	R/G	G/B

(R)	(F)						
G	G/W	R/B	L/R	W/G	L/W	B/Y	R/W
G/W	G/B	LG	G	W/R	L	L	L/W

FR-03 CONNECTOR BETWEEN FRONT(F) AND REAR(R) HARNESS

(F)	(R)						
LG/R	G/Y	BR/R	G/B	B/G	B	B/L	L/B
BR	BR/Y	L/O	Y/R	W	LG	L/W	L/Y

(R)	(F)						
L/B	B/L	B	B/G	G/B	BR/R	G/Y	LG/R
R	L/Y	LG/W	LG	W	Y/R	L/O	BR/Y

FC-01 CONNECTOR BETWEEN FRONT(F) AND CLUSTER SWITCH(CR2) HARNESS

(F)	(CR2)								
L/O	L/W	L	G/W	B/G	LG	B/Y	L/W	G/Y	B
L/R	L/Y	R/W	B/Y	*	G/W	L/R	G/O	G	*

(CR2)	(F)								
B	G/Y	L/W	B/Y	G/O	R/G	B/R	L	L/W	L/O
*	G	G/L	L/R	G/W	*	*	L/G	L/B	L/Y

50 WIRING DIAGRAM

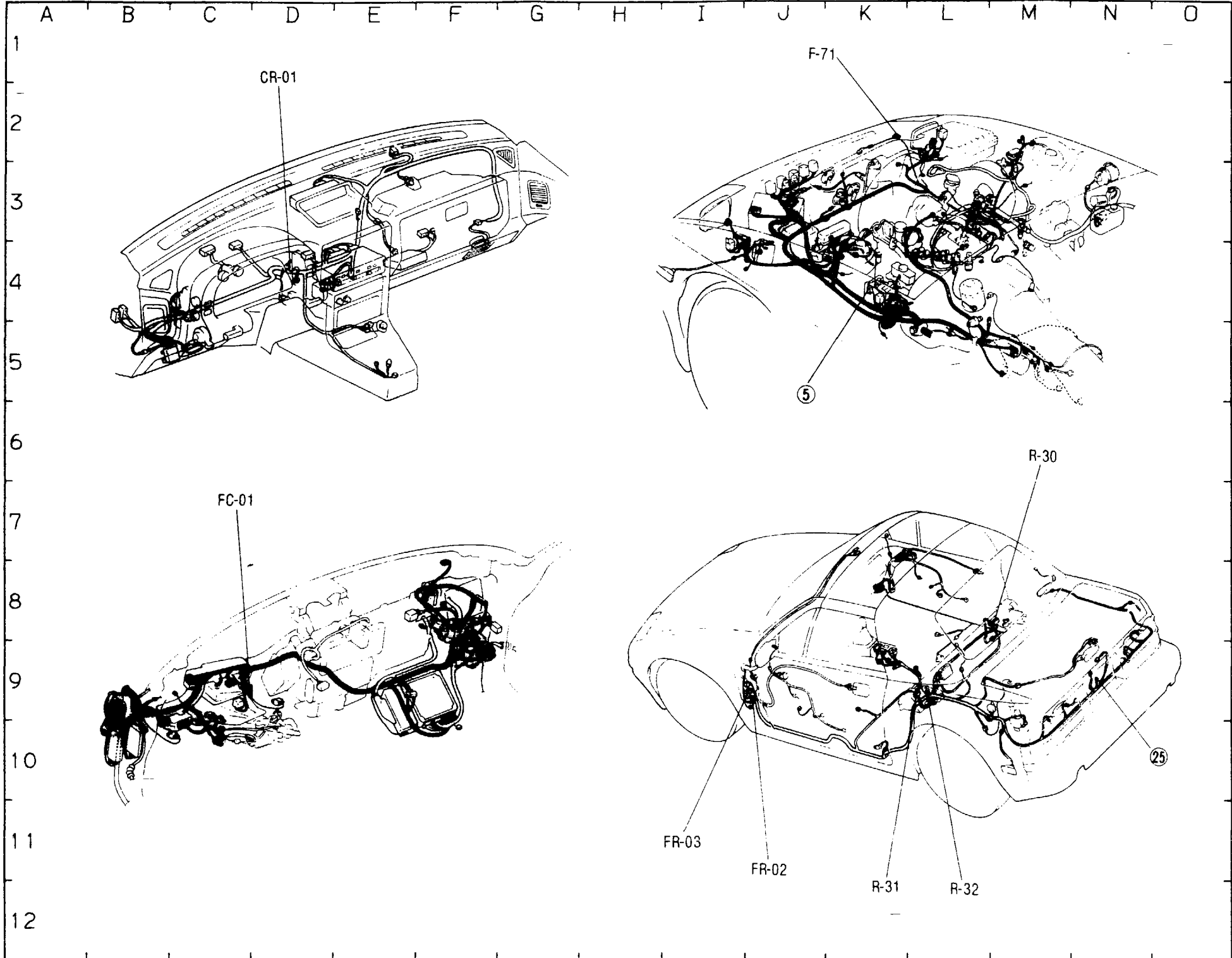

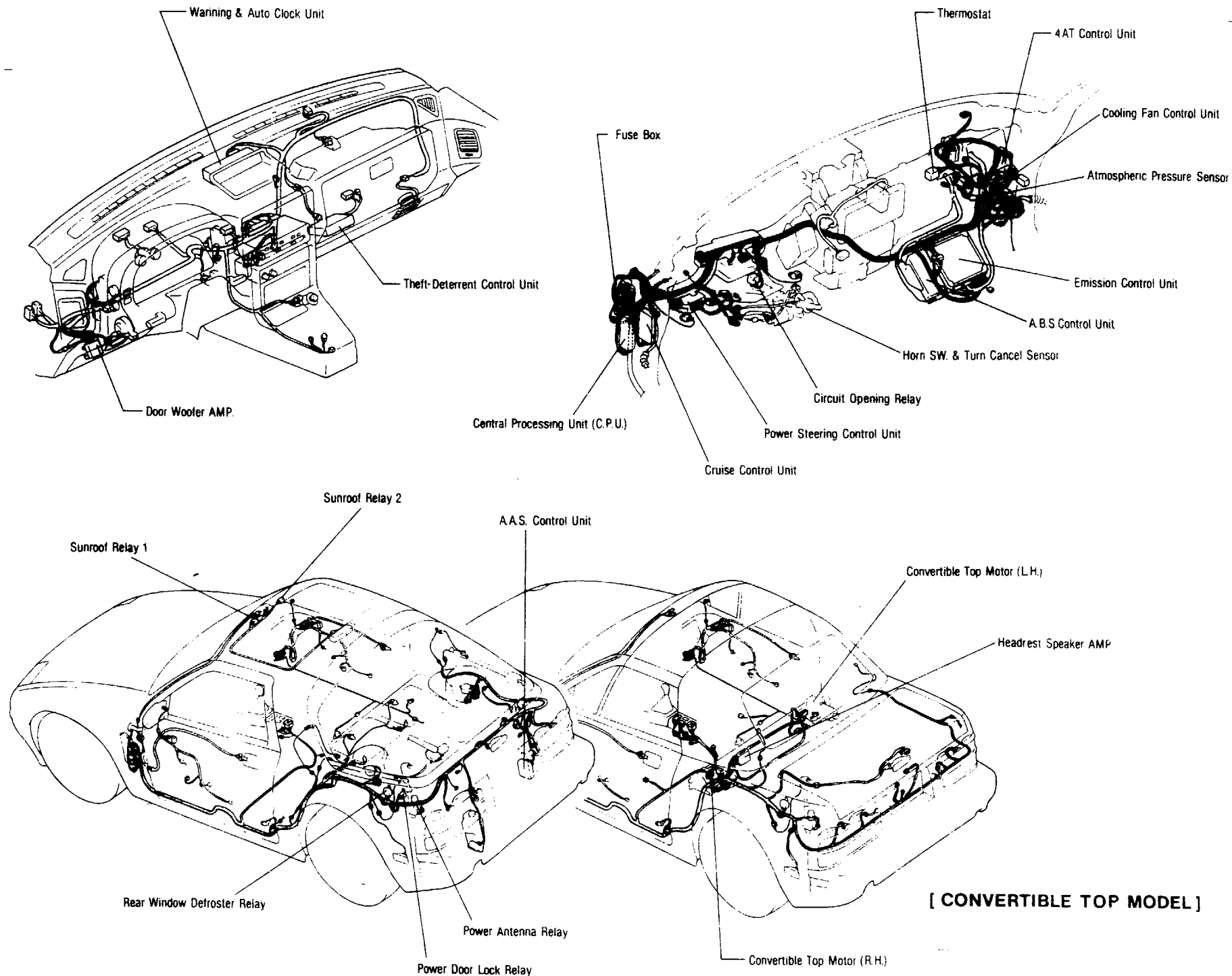

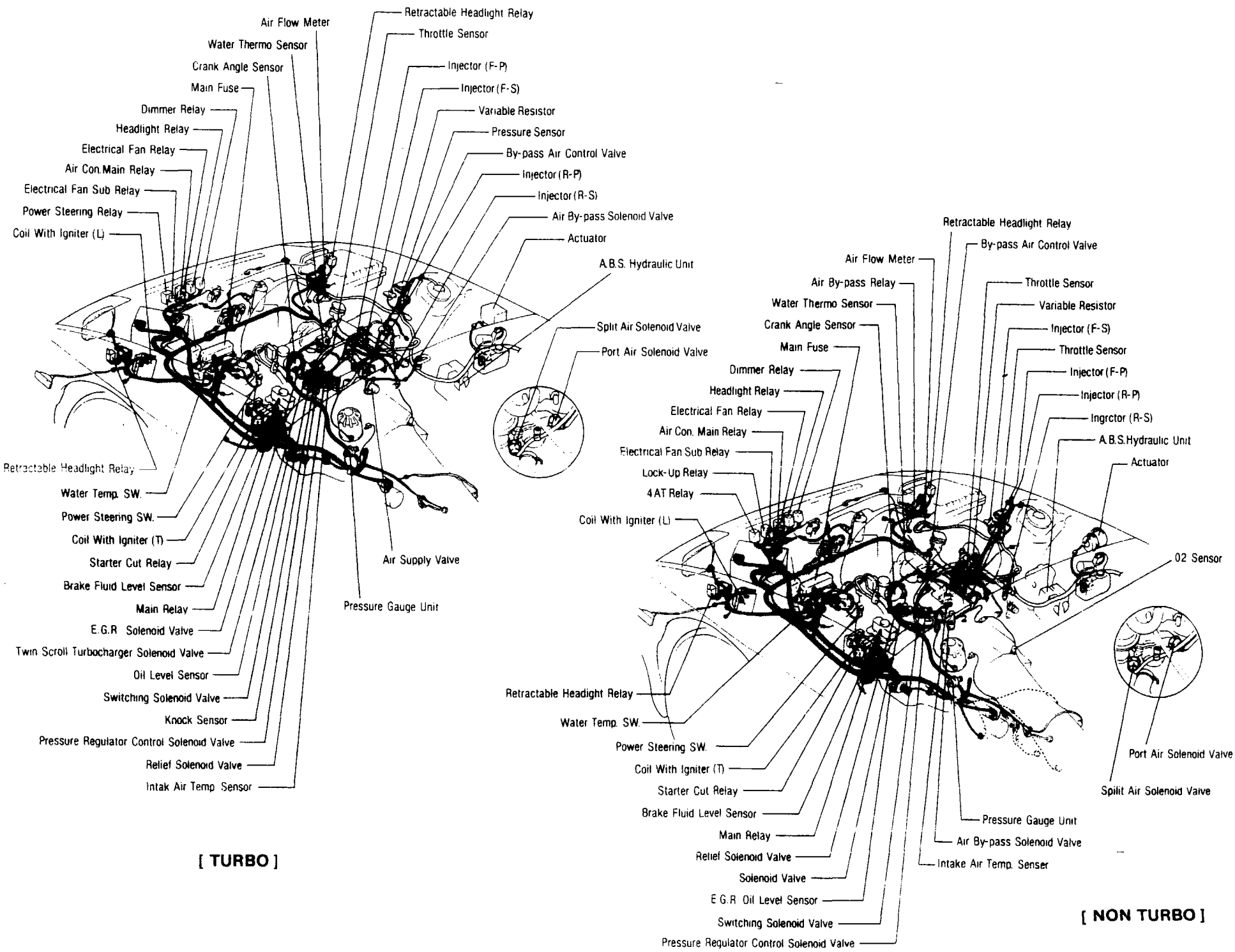

50 WIRING DIAGRAM

NOTE: X... NOT USED

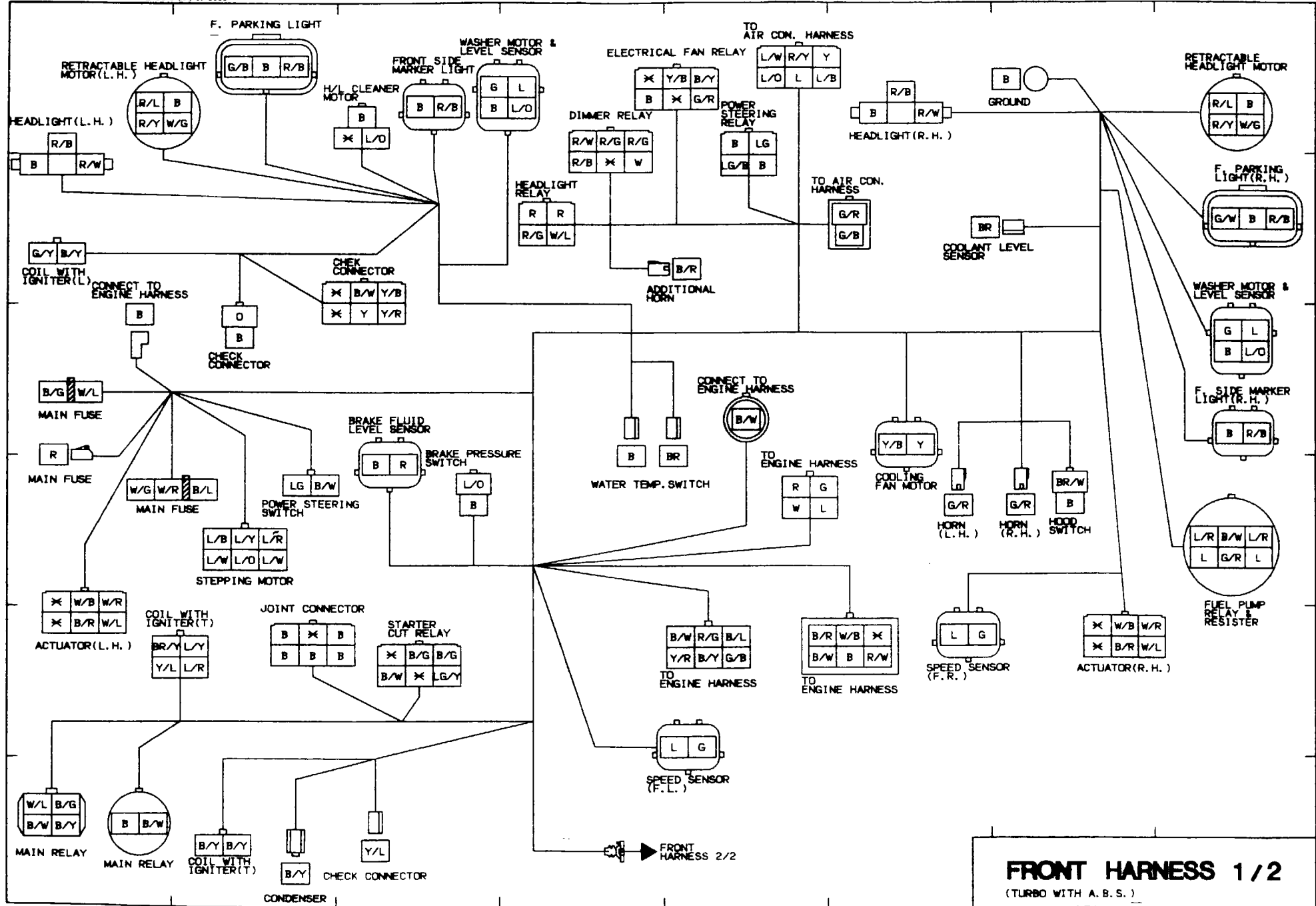

NOTE: *... NOT USED

WIRING DIAGRAM 50

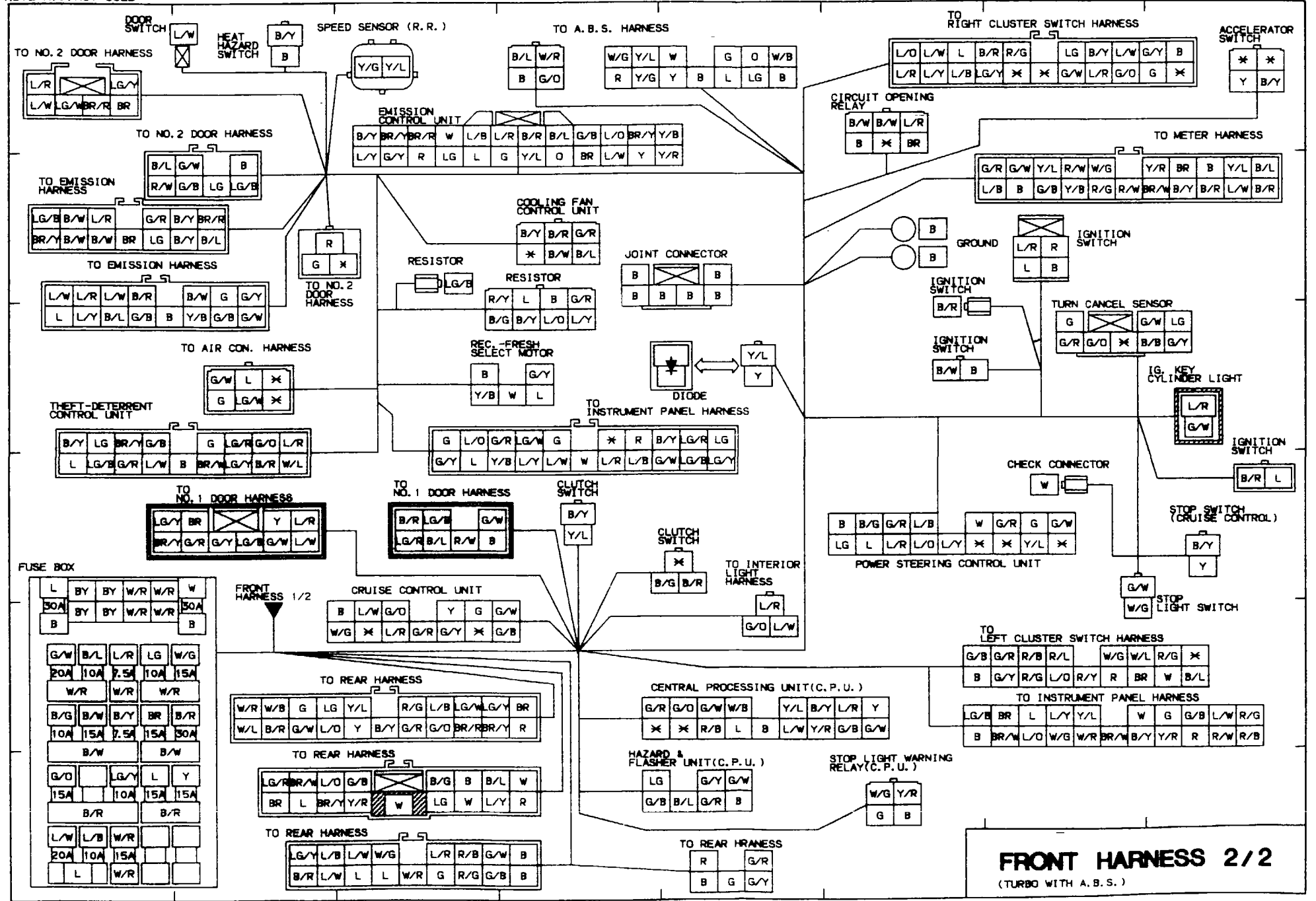

FRONT HARNESS 2/2
(TURBO WITH A. B. S.)

50 WIRING DIAGRAM

NOTE: *...NOT USED

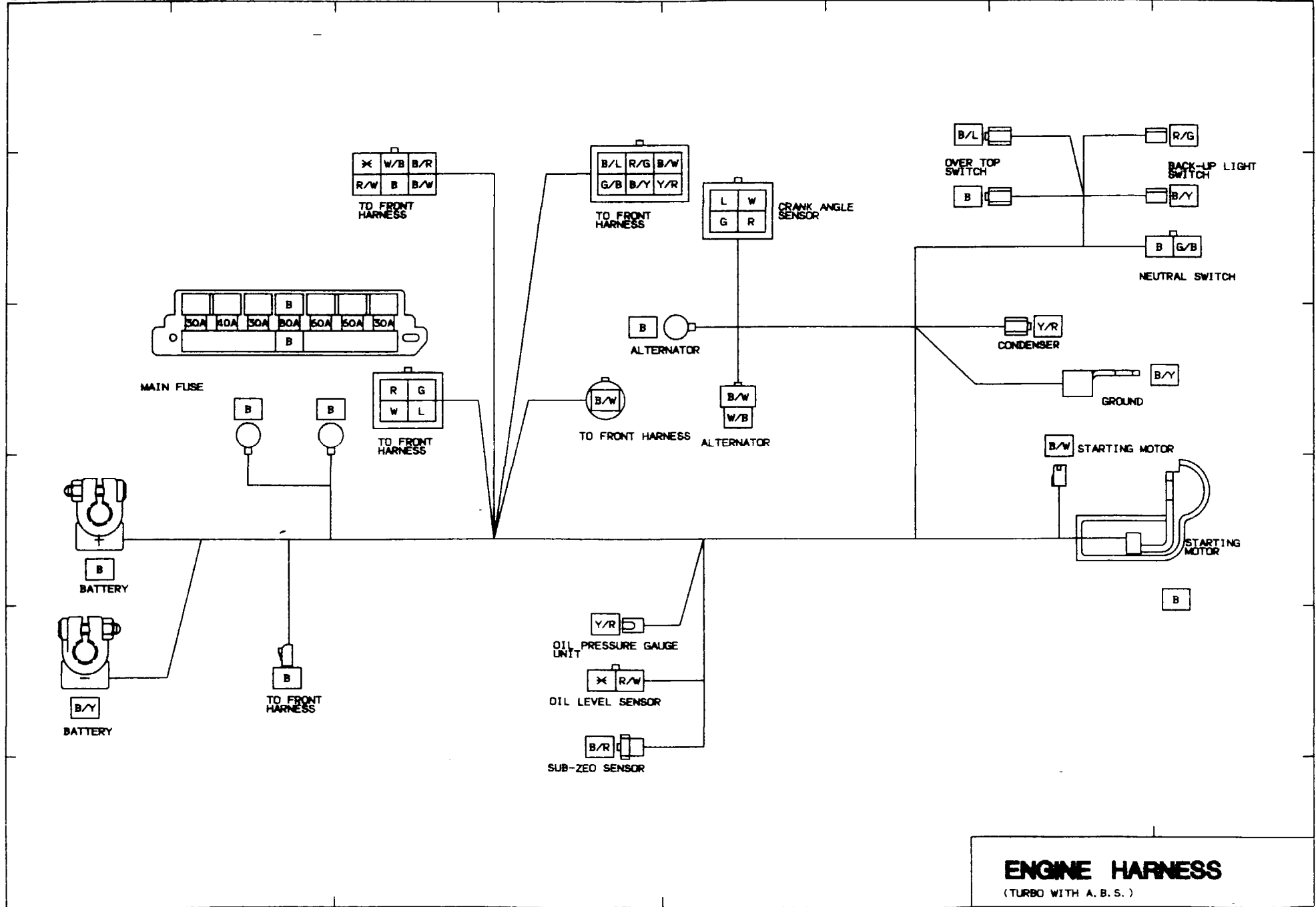

NOTE: * . . NOT USED

WIRING DIAGRAM 50

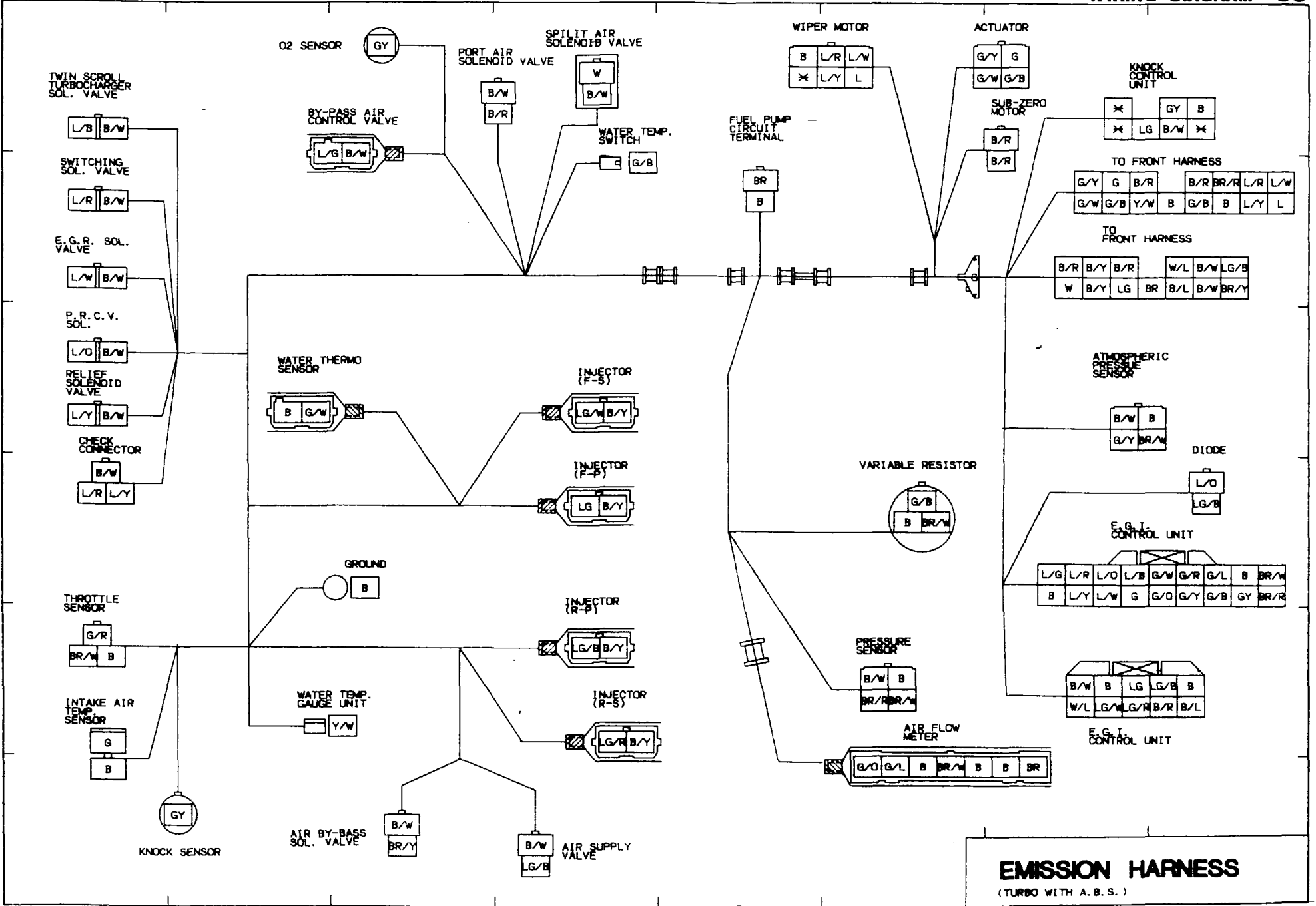

EMISSION HARNESS
(TURBO WITH A. B. S.)

50 WIRING DIAGRAM

NOTE: *... NOT USED

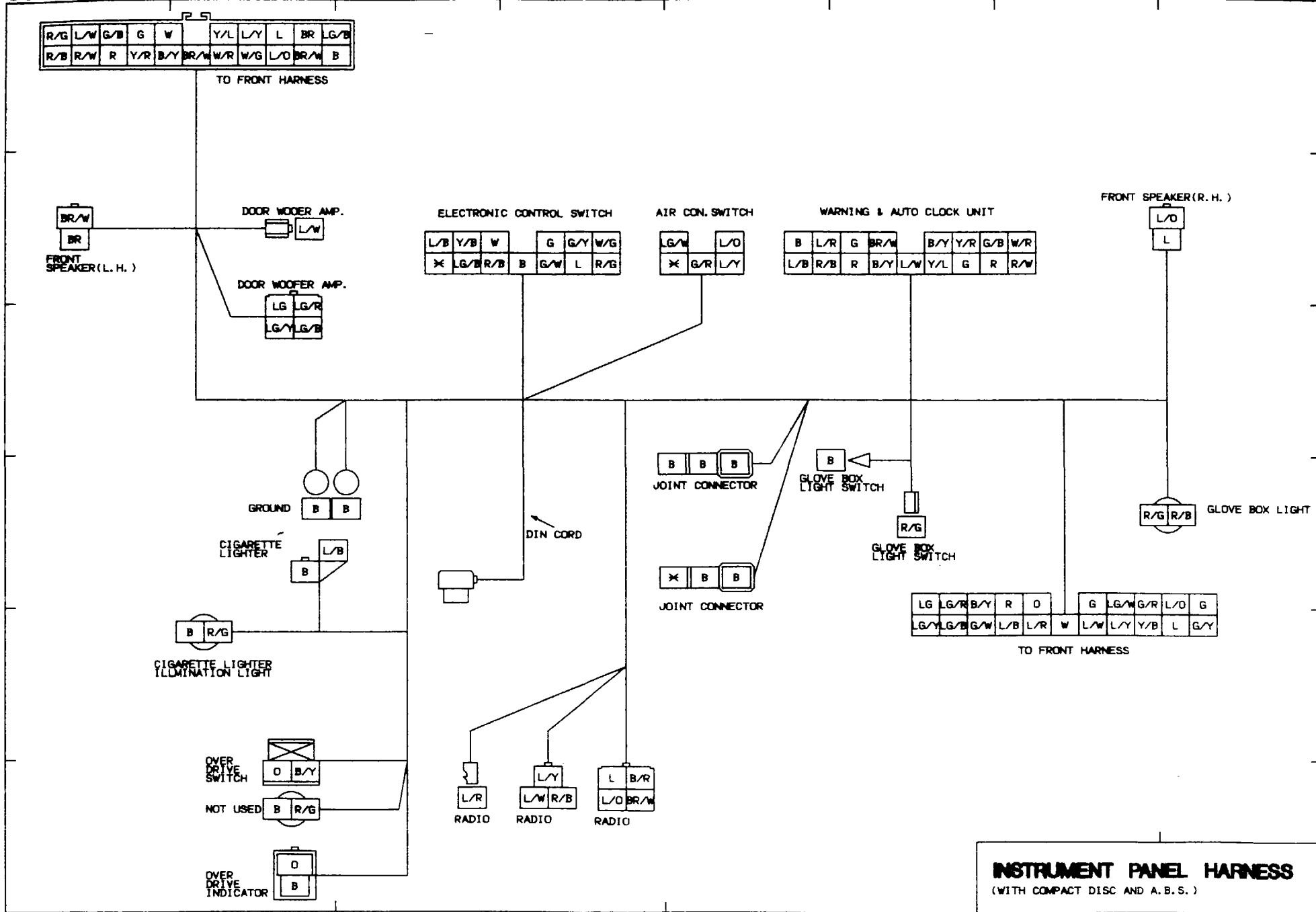

INSTRUMENT PANEL HARNESS
(WITH COMPACT DISC AND A. B. S.)

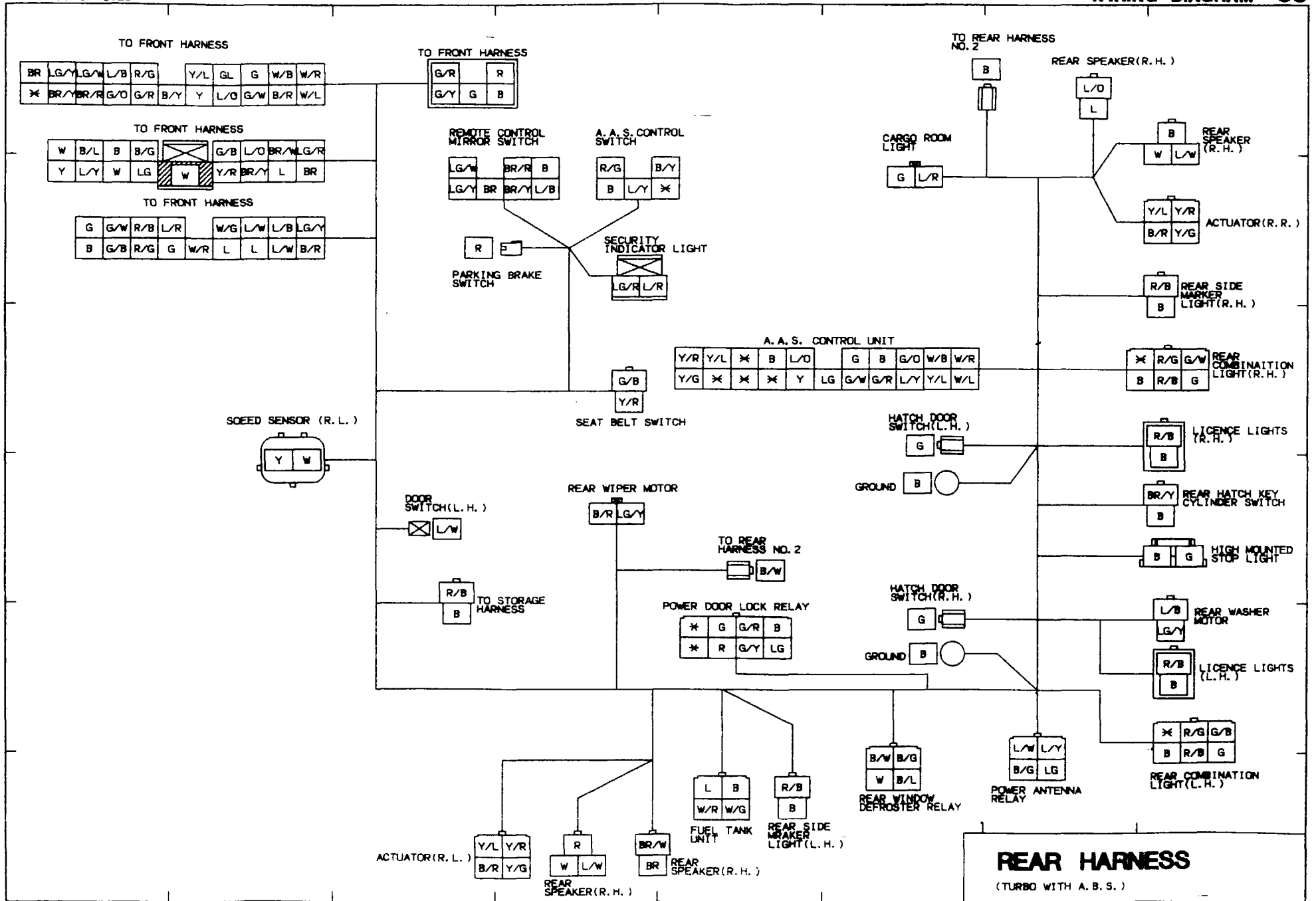

GROUND CIRCUIT

