



This document is brought to you through the kind services of

Kevin Wright

krwright@wankel.net

<http://www.wankel.net/~krwright>

who, well, didn't do much this time, since Paul Lee provided the thing already scanned and compiled into a PDF! (Thanks!). Go visit his website: <http://www.iluvmyrx7.com/index.htm> Lots of RX-7 goodness there.

There are several ways to get around in the document. I have provided Bookmarks to all the sections, and thumbnails are also provided in the Thumbnails side bar.

I have also included a label for the spine of a binder, for those who wish to print out all the pages and keep a dead-tree edition handy.☺

The original document is © 1979 Toyo Kogyo Co., Ltd., and remains so. This version is provided as a service for owners of first generation Mazda RX-7s who are having a devil of a time locating the factory service manual for a reasonable price.

If you really want to send me money, email me and I'll tell you where to send it, but it's not necessary. Consider this payoff for all the good advice and information gleaned from the various RX-7 email lists!

Subscribe to the Early Mazda Rotaries email list:

Send an email with "subscribe" (without the quotes) to list-request@sa22c.org

See <http://www.dfw-rx7.com> for information on the DFW-RX7 email list.

09/16/03

7A-A. TRANSMISSION REMOVAL
The procedure for removing the transmission from the vehicle are as follows:

Apply the parking brake and block the wheels.

1. Open the hood and disconnect the battery negative cable.



AUTOMATIC TRANSMISSION

7A-A.	TRANSMISSION REMOVAL	7A : 1
7A-B.	TRANSMISSION DISASSEMBLY	7A : 3
7A-C.	COMPONENT PARTS SERVICE	7A : 6
	7A-C-1. Front Clutch and Rear Clutch	7A : 6
	7A-C-2. Low and Reverse Brake	7A : 8
	7A-C-3. Servo	7A : 9
	7A-C-4. Governor and Oil Distributor	7A : 10
	7A-C-5. Oil Pump	7A : 10
	7A-C-6. Control Valve Body	7A : 12
	7A-C-7. Planet Carrier	7A : 14
	7A-C-8. One-way Clutch	7A : 14
	7A-C-9. Extension Housing	7A : 15
	7A-C-10. Transmission Case	7A : 15
7A-D.	TRANSMISSION ASSEMBLY	7A : 16
7A-E.	TRANSMISSION INSTALLATION	7A : 18
7A-F.	HYDRAULIC CONTROL INSPECTION	7A : 18
	7A-F-1. Checking Transmission Fluid Level	7A : 18
	7A-F-2. Checking Line Pressure	7A : 18
	7A-F-3. Checking Governor Pressure	7A : 19
	7A-F-4. Stall Test	7A : 19
	7A-F-5. Checking Shift Point	7A : 19
7A-G.	SHIFT CONTROL LINKAGE	7A : 20
	7A-G-1. Adjusting Manual Linkage	7A : 20
	7A-G-2. Adjusting Selector Lever Knob	7A : 20
	7A-G-3. Adjusting Kick-down Switch	7A : 20
	7A-G-4. Adjusting Inhibitor Switch	7A : 21

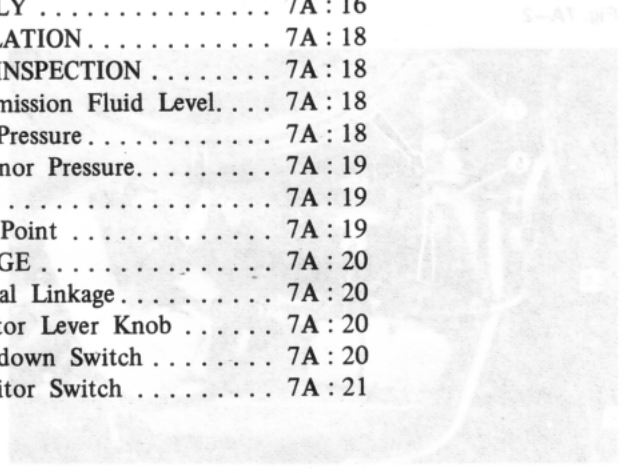
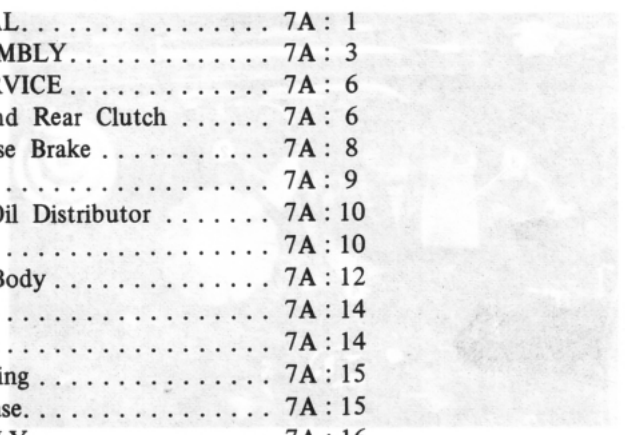

8. Remove the propeller shaft referring to Part 8-A. Install the turning holder (P/N 6237 410) into the extension housing to prevent junction from leaning out of the housing.

9. Jack up the vehicle and support it with stands.





Fig. 7A-1

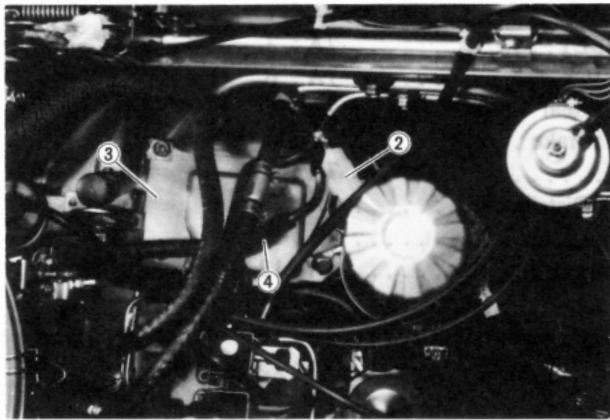

Fig. 7A-2

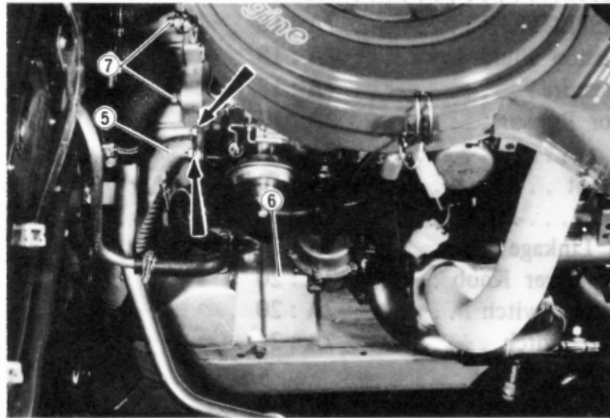

Fig. 7A-3

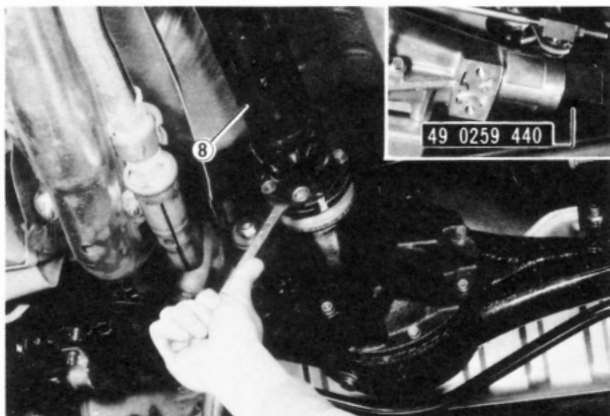

Fig. 7A-4

7A-A. TRANSMISSION REMOVAL

The procedures for removing the transmission from the vehicle are as follows:

Apply the parking brake and block the wheels.

1. Open the bonnet and disconnect the battery negative cable.

AUTOMATIC

2. Disconnect the inhibitor switch coupler.

3. Remove the converter housing upper cover.

4. Disconnect the vacuum sensing tube of the vacuum diaphragm.

5. Remove the nuts and disconnect the air pipe.

6. Remove the thermal reactor cover.

7. Remove the bolts attaching the transmission to rear end of the engine.

Jack up the vehicle and support it with stands.

8. Remove the propeller shaft referring to Par. 8-A. Install the **turning holder** (49 0259 440) into the extension housing to prevent lubricant from leaking out of the housing.

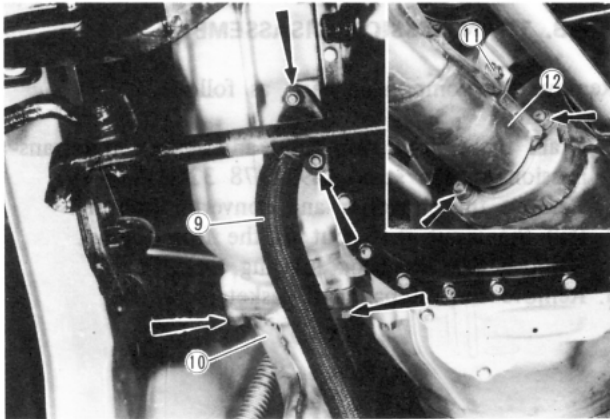

Fig. 7A-5

9. Remove the air pipe (thermal reactor ~ air duct).
10. Remove the nuts and disconnect the air duct from the thermal reactor.
11. Disconnect the air duct hanger.
12. Disconnect the air duct from the silencer.

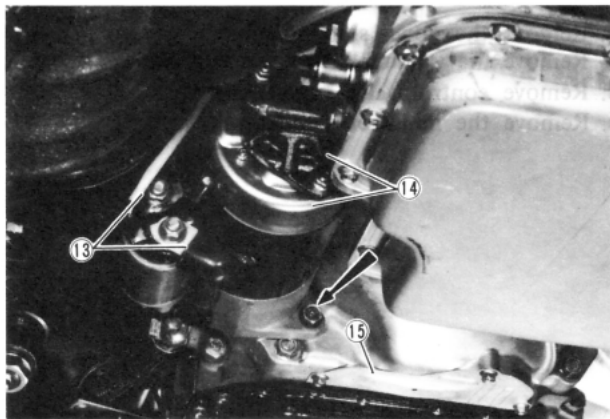

Fig. 7A-6

13. Disconnect the starting motor wirings.
14. Remove the bracket and then, the starting motor.
15. Remove the converter housing lower cover.

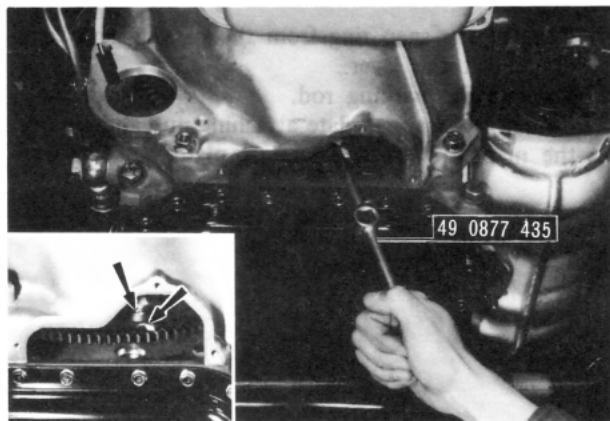

Fig. 7A-7

16. Mark the drive plate and torque converter for correct realignment during re-installation. Using the **wrench** (49 0877 435), remove the bolts attaching the torque converter to the drive plate.
17. Remove the bolts attaching the transmission to rear end of the engine.

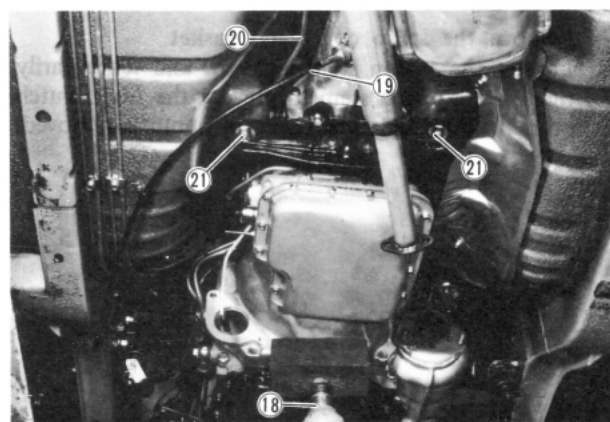

Fig. 7A-8

18. Place the jack under the transmission and the engine, and support them securely.
19. Disconnect the speedometer cable.
20. Disconnect the select rod at the select lever.
21. Remove the nuts attaching the transmission support to the body.
22. Lower the transmission enough to disconnect the fluid pipes and disconnect the fluid pipes from the transmission housing.
23. Slide the transmission rearward until the input shaft clears the rear end of the eccentric shaft and carefully remove the transmission and torque converter assembly from under the vehicle.

7A

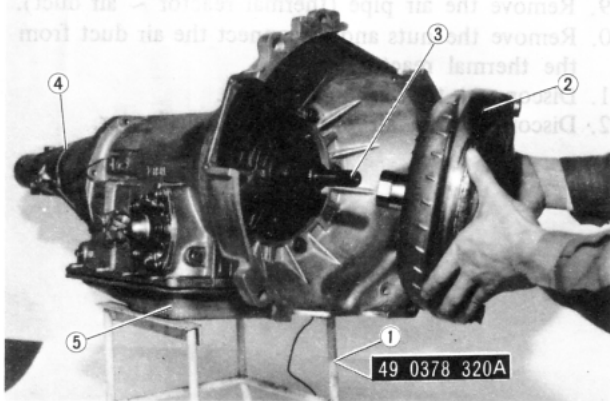

Fig. 7A-9

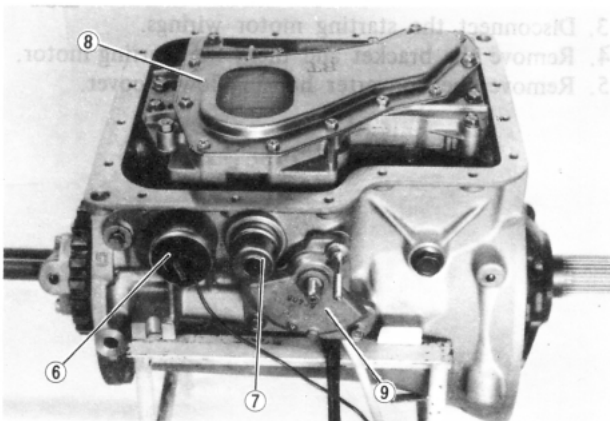

Fig. 7A-10

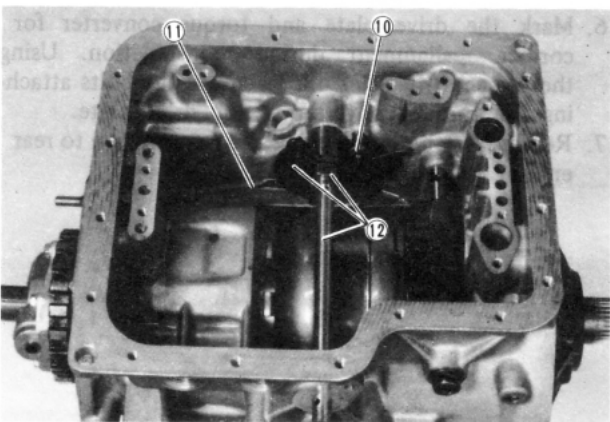

Fig. 7A-11

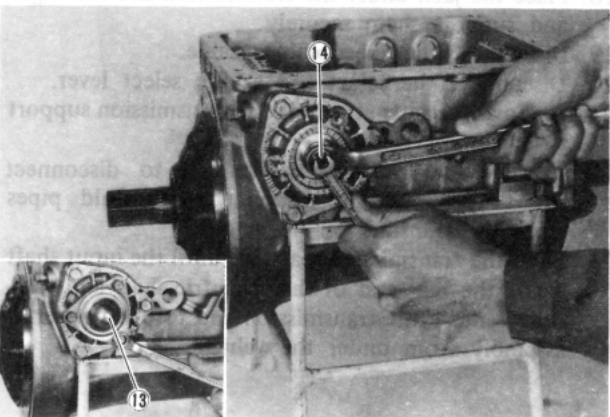

Fig. 7A-12

7A-B. TRANSMISSION DISASSEMBLY

Remove the component parts as follows.

1. Drain the transmission fluid and mount the transmission on the **stand** (49 0378 320A).
2. Remove the converter and converter housing.
3. Pull the input shaft out of the front pump.
4. Remove the extension housing.
5. Remove the oil pan and gasket.
6. Remove the down shift solenoid.
7. Remove the vacuum diaphragm and diaphragm rod.
8. Remove control valve body assembly.
9. Remove the inhibitor switch.
10. Remove the snap ring from the parking lever and disconnect the lever.
11. Remove the parking rod.
12. Loosen the manual plate attaching nut, and remove the manual shaft and manual plate.
13. Remove the servo cover and gasket.
14. Loosen the piston stem lock nut and temporarily tighten the piston stem to prevent the front clutch drum from falling when the oil pump is removed.

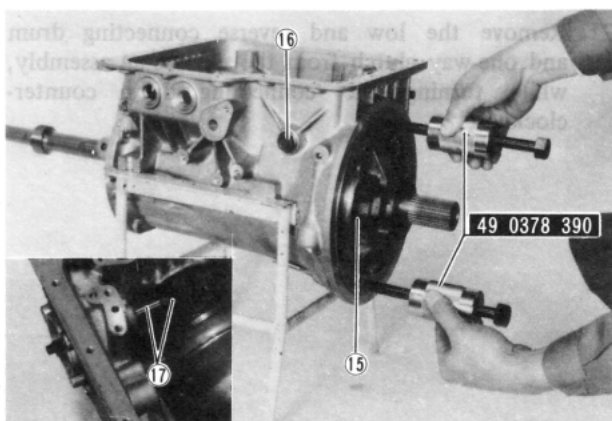

Fig. 7A-13

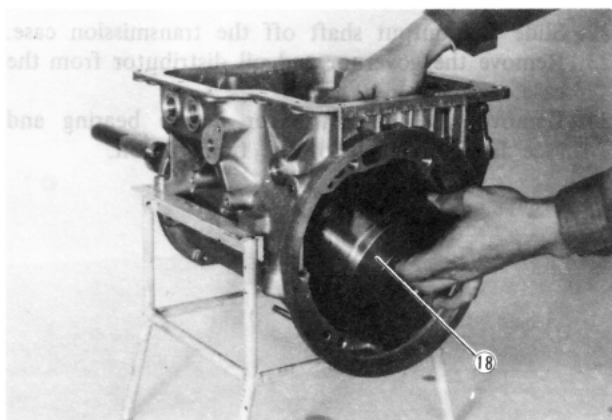

Fig. 7A-14

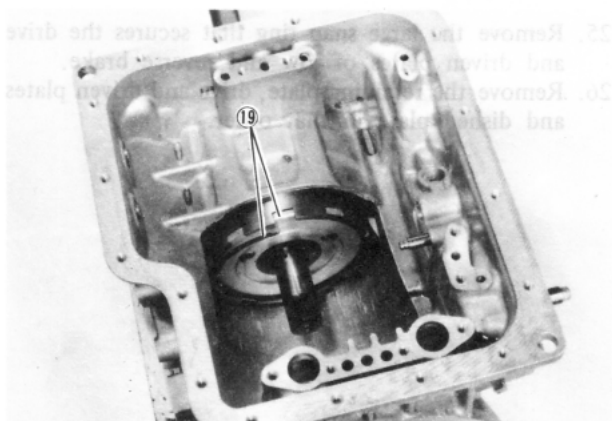

Fig. 7A-15



Fig. 7A-16

15. Remove the oil pump using the **puller** (49 0378 390).

16. Remove the band retaining bolt.

17. Loosen the piston stem and remove the band strut.

18. Remove the band, front clutch assembly, rear clutch assembly, front planet carrier assembly and sun gear as an assembly.

19. Remove the large snap ring that secures the rear planet carrier to the connecting drum. Remove the rear planet carrier from the drum.

20. Remove the snap ring on the output shaft using the **pliers** (49 8000 015), and remove the internal drive flange.

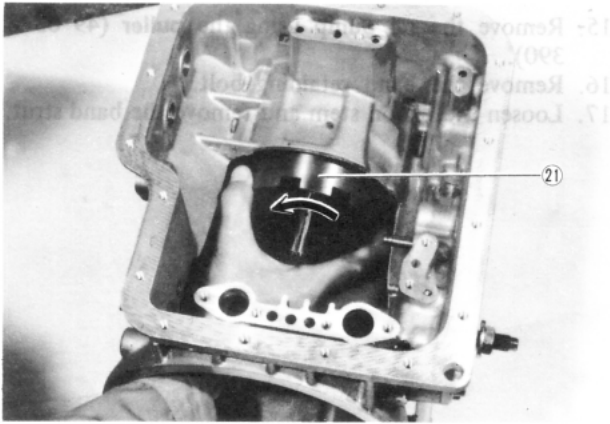

Fig. 7A-17

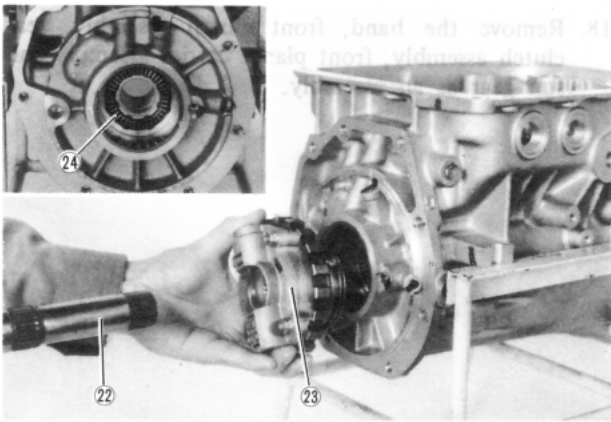

Fig. 7A-18

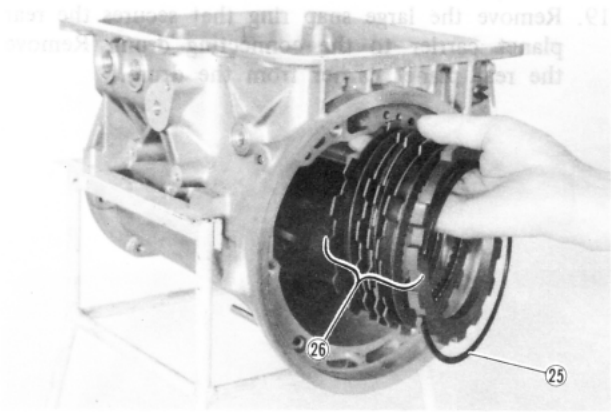

Fig. 7A-19

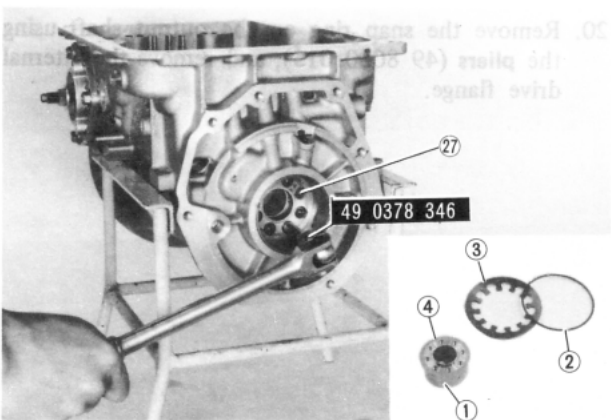

Fig. 7A-20

21. Remove the low and reverse connecting drum and one-way clutch from the case as an assembly, while turning the connecting drum counter-clockwise.

22. Slide the output shaft off the transmission case.
23. Remove the governor and oil distributor from the case.

24. Remove the oil distributor needle bearing and race from rear side of the transmission.

25. Remove the large snap ring that secures the drive and driven plates of low and reverse brake.

26. Remove the retaining plate, drive and driven plates and dished plate in that order.

27. Loosen the inner race attaching bolts of one-way clutch using the **hex-head wrench** (49 0378 346), and remove the inner race (1), spring ring (2), piston return spring (3) and thrust spring ring (4), from inside the case being careful not to drop them.

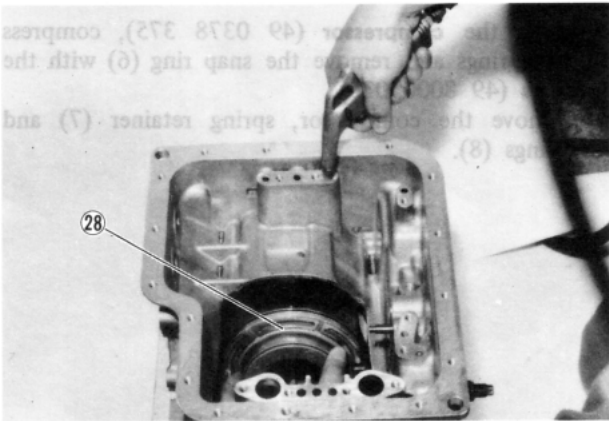

Fig. 7A-21

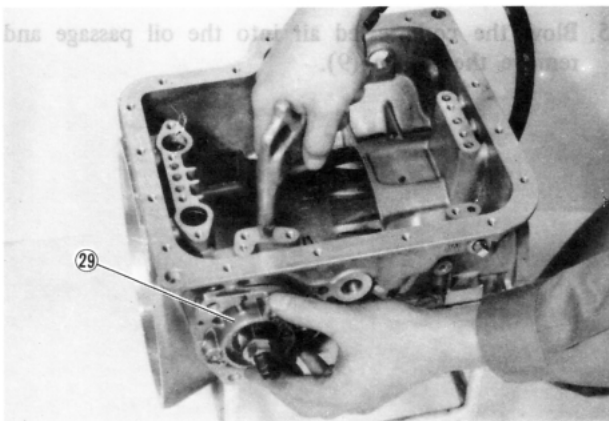

Fig. 7A-22

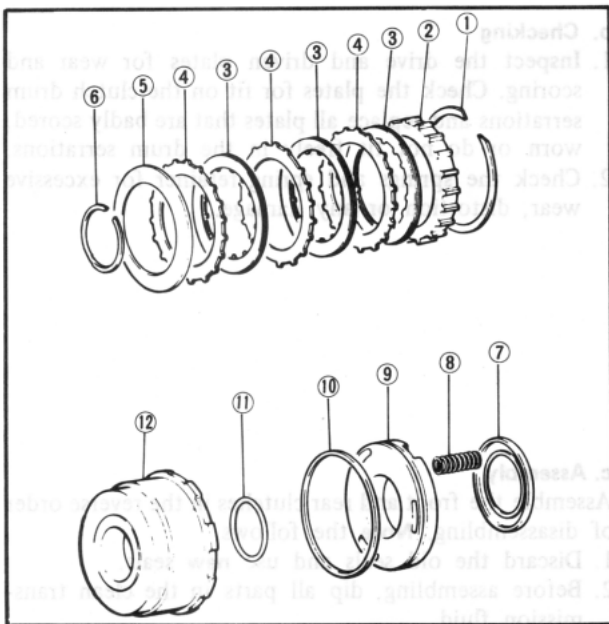

Fig. 7A-23

28. Blow the compressed air into the oil passage located at the rear of the case and remove the low and reverse brake piston.

29. Remove the servo retainer attaching bolts. Blow the compressed air into the oil passage and remove the servo assembly from the case.

7A-C. COMPONENT PARTS SERVICE

7A-C-1. Front Clutch and Rear Clutch

a. Disassembly

1. Remove the snap ring (1).
2. Remove the retaining plate (2), drive plates (3), driven plates (4) and dished plate (5).

- 1) Snap ring
- 2) Retaining plate
- 3) Drive plates
- 4) Driven plates
- 5) Dished plate
- 6) Snap ring
- 7) Spring retainer
- 8) Spring
- 9) Piston
- 10) Outer seal
- 11) Inner seal
- 12) Clutch drum

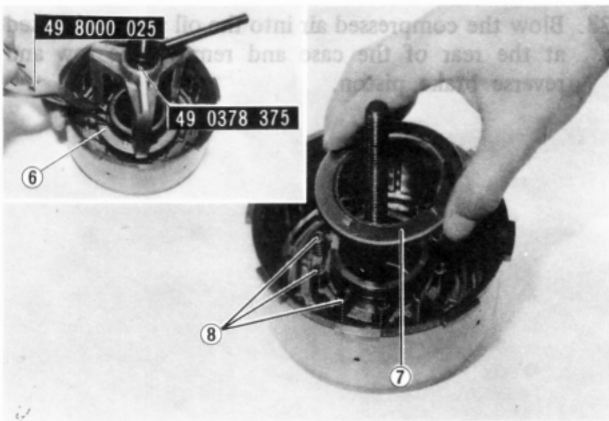

Fig. 7A-24



Fig. 7A-25

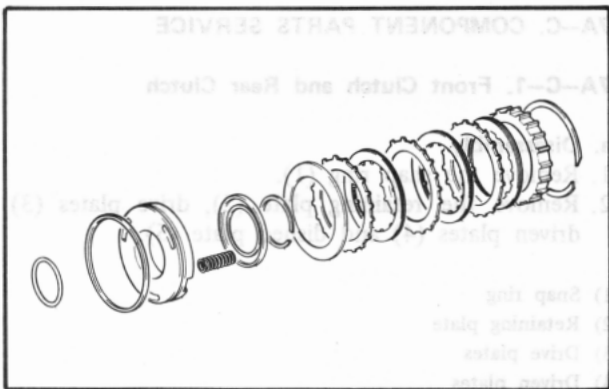

Fig. 7A-26

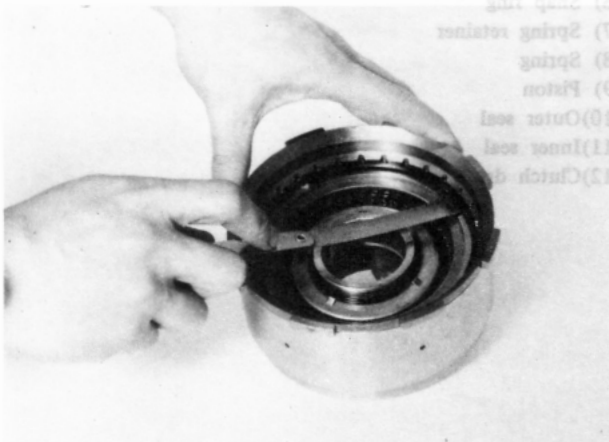

Fig. 7A-27

3. Using the **compressor** (49 0378 375), compress the springs and remove the snap ring (6) with the **pliers** (49 8000 025).
4. Remove the compressor, spring retainer (7) and springs (8).

5. Blow the compressed air into the oil passage and remove the piston (9).

b. Checking

1. Inspect the drive and driven plates for wear and scoring. Check the plates for fit on the clutch drum serrations and replace all plates that are badly scored, worn or do not fit freely in the drum serrations.
2. Check the springs and spring retainer for excessive wear, distortion or any damage.

c. Assembly

Assemble the front and rear clutches in the reverse order of disassembling. **Note** the follows.

1. Discard the old seals and use **new** seals.
2. Before assembling, dip all parts in the clean transmission fluid.
3. On the front clutch assembly, check the clearance between the retaining plate and snap ring with a feeler gauge. If the clearance is not within the specifications, adjust it with correct retaining plate.

Clearance: 1.6 ~ 1.8 mm (0.063 ~ 0.071 in)

Available retaining plates (for front clutch)

7.2 mm (0.283 in)	7.6 mm (0.299 in)	8.0 mm (0.315 in)
7.4 mm (0.291 in)	7.8 mm (0.307 in)	8.2 mm (0.323 in)



Fig. 7A-28

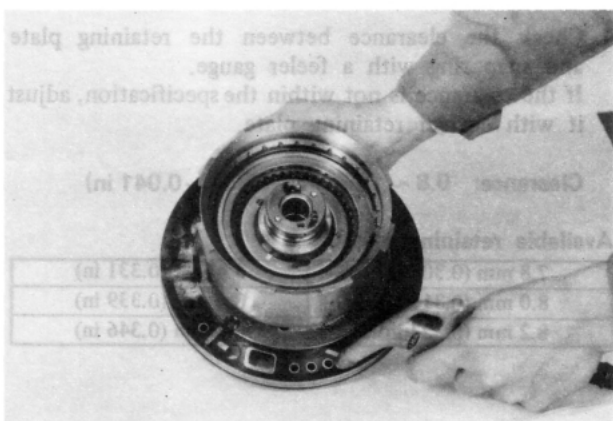

Fig. 7A-29

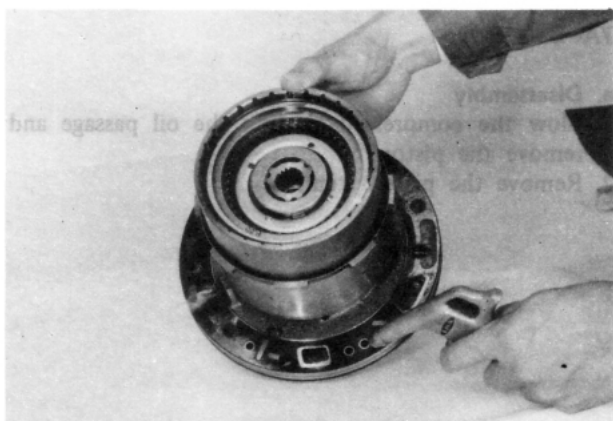

Fig. 7A-30



Fig. 7A-31

On the rear clutch assembly, check the clearance between the retaining plate and snap ring. If the clearance is not within the specifications, replace the all drive and driven plates.

Clearance: 0.8 ~ 1.5 mm (0.031 ~ 0.059 in)

4. Install the front clutch assembly onto the oil pump assembly. Blow the compressed air into the oil passage and check the front clutch operation.

5. Install the rear clutch assembly onto the oil pump assembly with front clutch assembly installed. Blow the compressed air into the oil passage and check the rear clutch operation.

7A-C-2. Low and Reverse Brake

a. Disassembly

To disassembly, follow the Steps 25 ~ 28 as described in Par. 7A-B.

b. Checking

1. Check the drive and driven plates for wear and scoring. Check the plates for fit on the transmission case serrations.
Replace all plates that are badly scored, worn or do not slide freely in the case serrations.
2. Check the piston return spring and piston for excessive wear, distortion or any damage.

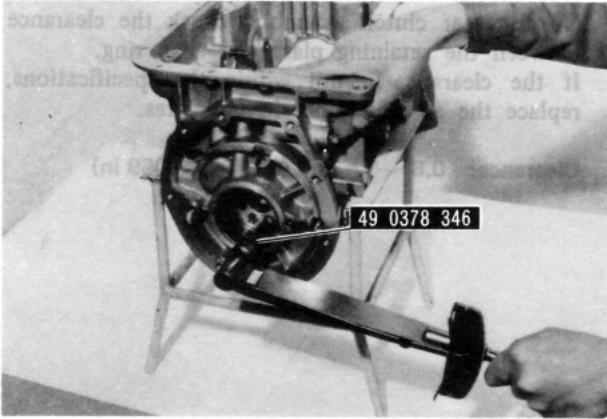

Fig. 7A-32

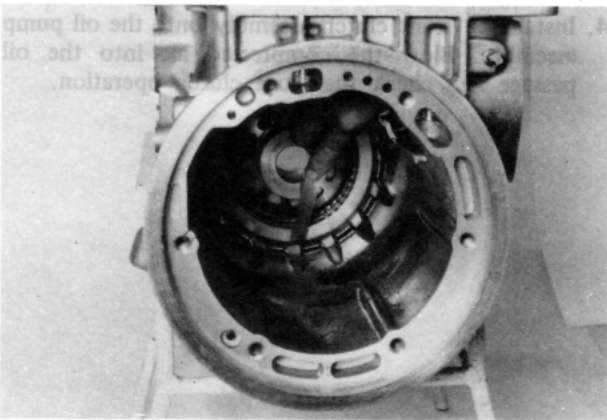

Fig. 7A-33

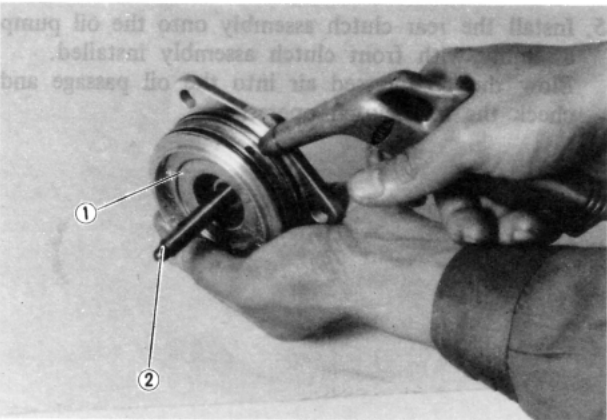

Fig. 7A-34

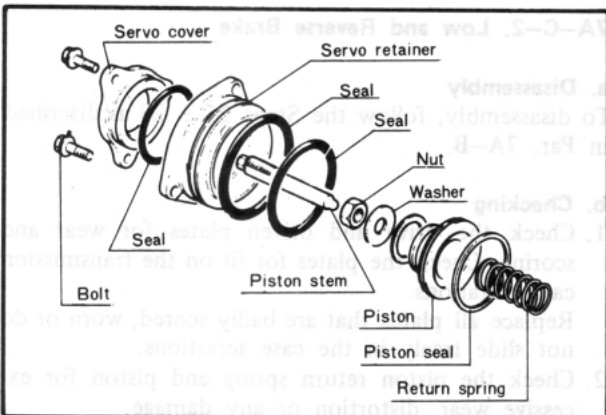

Fig. 7A-35

c. Assemble

Assemble the low and reverse brake in the reverse order of disassembling. **Note** the follows.

1. Discard the old seals and use **new** seals.
2. Before assembling, dip all parts in clean transmission fluid.
3. Tighten the one-way clutch inner race attaching bolts to **1.3 ~ 1.8 m-kg (9 ~ 13 ft-lb)**, using the **hex-head wrench (49 0378 346)**.

4. Check the clearance between the retaining plate and snap ring with a feeler gauge. If the clearance is not within the specification, adjust it with correct retaining plate.

Clearance: 0.8 ~ 1.05 mm (0.031 ~ 0.041 in)

Available retaining plates

7.8 mm (0.307 in)	8.4 mm (0.331 in)
8.0 mm (0.315 in)	8.6 mm (0.339 in)
8.2 mm (0.323 in)	8.8 mm (0.346 in)

7A-C-3. Servo

a. Disassembly

1. Blow the compressed air into the oil passage and remove the piston.
2. Remove the piston stem.

b. Checking

1. Inspect the servo bore for cracks, and the piston bore and piston stem for scores.
2. Check the piston stem for free movement and wear.
3. Check the servo spring for weakness.
4. Inspect the band lining for excessive wear and damage.

c. Assembly

Assemble the servo in the reverse order of disassembling. **Note** the follows.

1. Discard the old seals and use **new** seals.
2. Before assembling, dip all parts in clean transmission fluid.

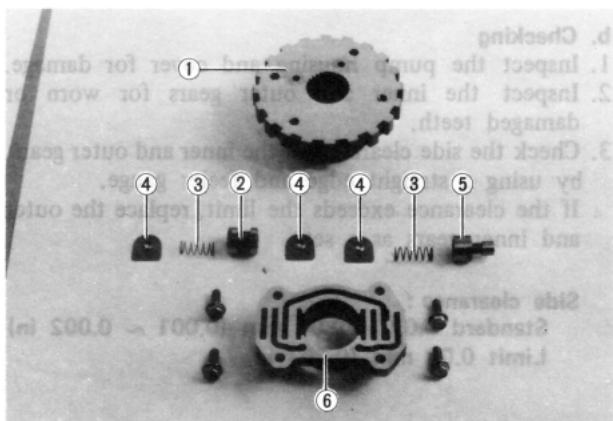

Fig. 7A-36



Fig. 7A-37



Fig. 7A-38

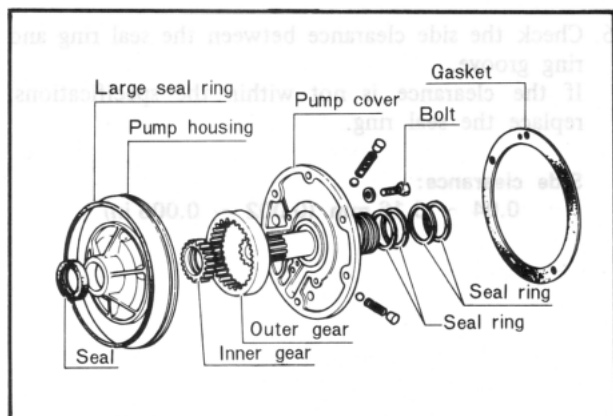

Fig. 7A-39

7A-C-4. Governor and Oil Distributor

a. Disassembly

1. Remove the governor valve body from the oil distributor.
2. Remove the valve retaining plates, and remove the primary and secondary governor valves and springs.

- 1) Oil distributor
- 2) Primary valve
- 3) Spring
- 4) Retaining plate
- 5) Secondary valve
- 6) Valve body

b. Checking

1. Inspect the governor valves and bores for scores.
2. Check for free movement of the valves. The valves should slide freely of their own weight in the bores when dry.
3. Check the spring for proper tension and the retaining plates for warpage.
4. Inspect the oil passages in the oil distributor for clog.
5. Check the side clearance between the seal ring and ring groove. If the clearance is not within the specification, replace the seal ring.

Side clearance : 0.04 ~ 0.16 mm (0.002 ~ 0.006 in)

c. Assembly

Assemble the governor and oil distributor in the reverse order of disassembling. **Note** the follows:

1. Before assembling, dip the all parts in clean transmission fluid.
2. Do not confuse the governor springs. The secondary governor spring is stronger than primary governor spring.
3. Install the governor body assembly to the oil distributor and tighten the bolts to 0.5 ~ 0.7 m-kg (3.6 ~ 5.1 ft-lb).

7A-C-5. Oil Pump

a. Disassembly

1. Remove the seal rings.
2. Remove the large seal ring from the pump housing.
3. Remove the pump cover attaching bolts and remove the pump cover.
4. Apply the marks onto the top surface of the pump inner and outer gears and remove the gears. **Do not** scratch the gear to mark.

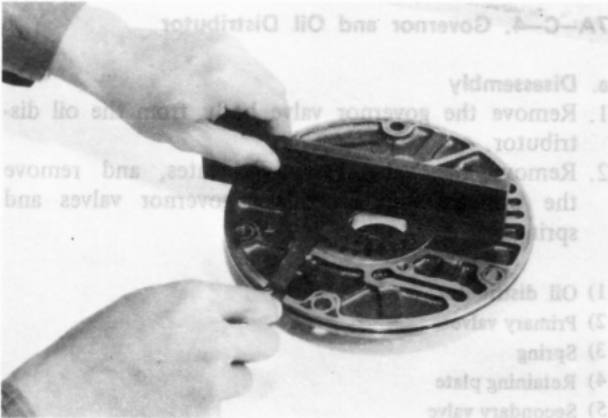

Fig. 7A-40

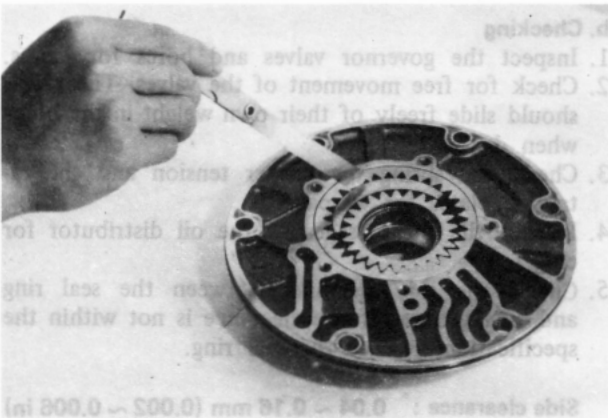

Fig. 7A-41

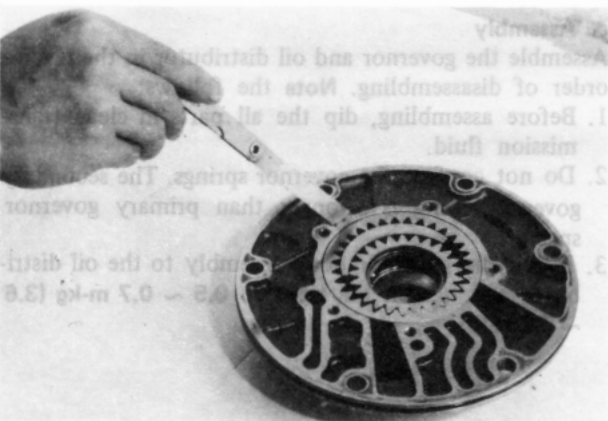

Fig. 7A-42

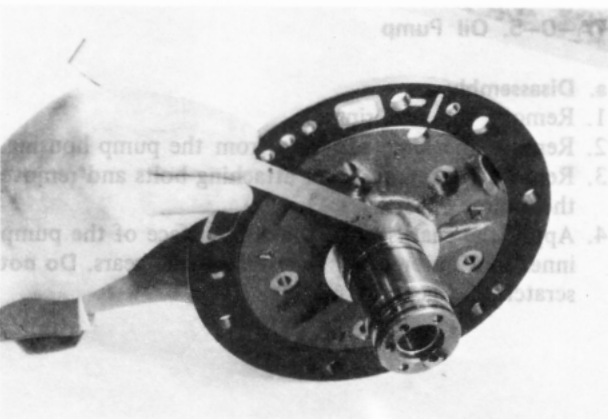

Fig. 7A-43

b. Checking

1. Inspect the pump housing and cover for damage.
2. Inspect the inner and outer gears for worn or damaged teeth.
3. Check the side clearance of the inner and outer gears, by using a straight edge and feeler gauge.
If the clearance exceeds the limit, replace the outer and inner gears as a set.

Side clearance :

Standard 0.02 ~ 0.04 mm (0.001 ~ 0.002 in)
Limit 0.08 mm (0.003 in)

4. Check the clearance between the outer gear teeth and crescent.
If the clearance exceeds the limit, replace the outer and inner gears as a set.

Clearance between the outer gear and crescent:

Standard 0.14 ~ 0.21 mm (0.006 ~ 0.008 in)
Limit 0.25 mm (0.010 in)

5. Check the clearance between the outer gear and housing. If the clearance exceeds the limit, replace the outer and inner gears as a set.

Clearance between the outer gear and housing:

Standard 0.05 ~ 0.20 mm (0.002 ~ 0.008 in)
Limit 0.25 mm (0.010 in)

6. Check the side clearance between the seal ring and ring groove.
If the clearance is not within the specifications, replace the seal ring.

Side clearance:

0.04 ~ 0.16 mm (0.002 ~ 0.006 in)

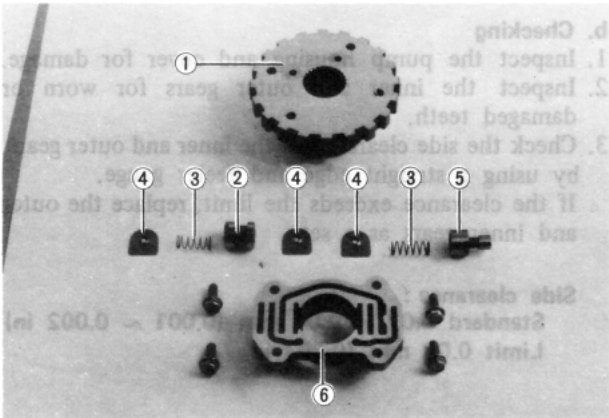

Fig. 7A-36

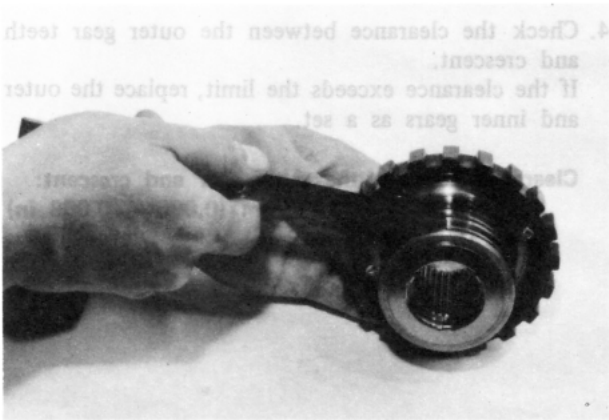

Fig. 7A-37

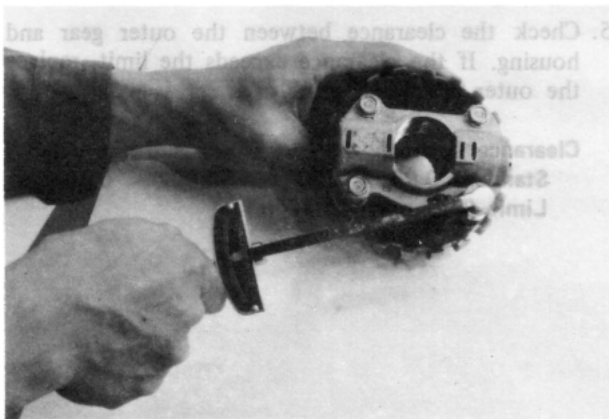

Fig. 7A-38

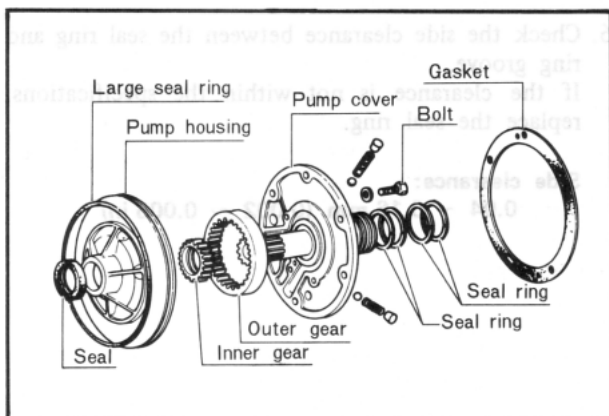

Fig. 7A-39

7A-C-4. Governor and Oil Distributor

a. Disassembly

1. Remove the governor valve body from the oil distributor.
2. Remove the valve retaining plates, and remove the primary and secondary governor valves and springs.

- 1) Oil distributor
- 2) Primary valve
- 3) Spring
- 4) Retaining plate
- 5) Secondary valve
- 6) Valve body

b. Checking

1. Inspect the governor valves and bores for scores.
2. Check for free movement of the valves. The valves should slide freely of their own weight in the bores when dry.
3. Check the spring for proper tension and the retaining plates for warpage.
4. Inspect the oil passages in the oil distributor for clog.
5. Check the side clearance between the seal ring and ring groove. If the clearance is not within the specification, replace the seal ring.

Side clearance : 0.04 ~ 0.16 mm (0.002 ~ 0.006 in)

c. Assembly

Assemble the governor and oil distributor in the reverse order of disassembling. **Note** the follows:

1. Before assembling, dip the all parts in clean transmission fluid.
2. Do not confuse the governor springs. The secondary governor spring is stronger than primary governor spring.
3. Install the governor body assembly to the oil distributor and tighten the bolts to 0.5 ~ 0.7 m·kg (3.6 ~ 5.1 ft·lb).

7A-C-5. Oil Pump

a. Disassembly

1. Remove the seal rings.
2. Remove the large seal ring from the pump housing.
3. Remove the pump cover attaching bolts and remove the pump cover.
4. Apply the marks onto the top surface of the pump inner and outer gears and remove the gears. **Do not** scratch the gear to mark.

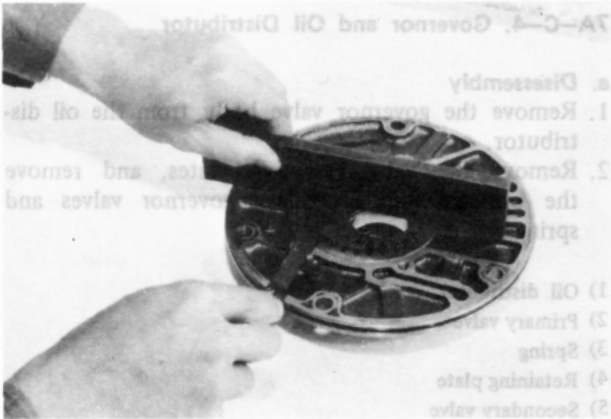

Fig. 7A-40

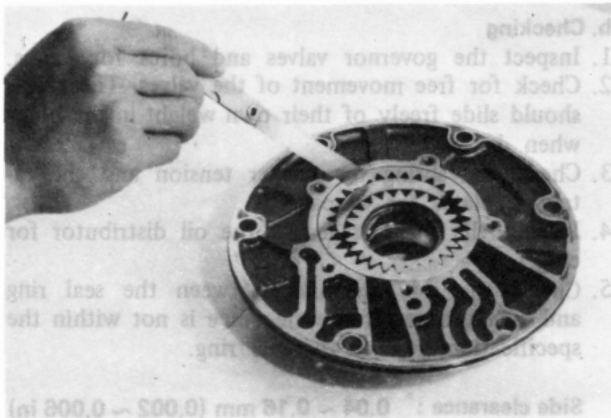

Fig. 7A-41

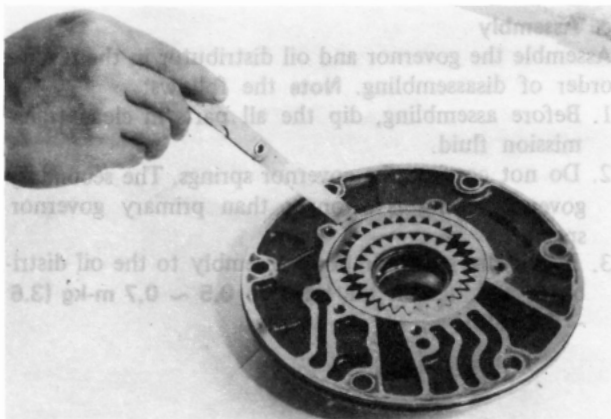

Fig. 7A-42

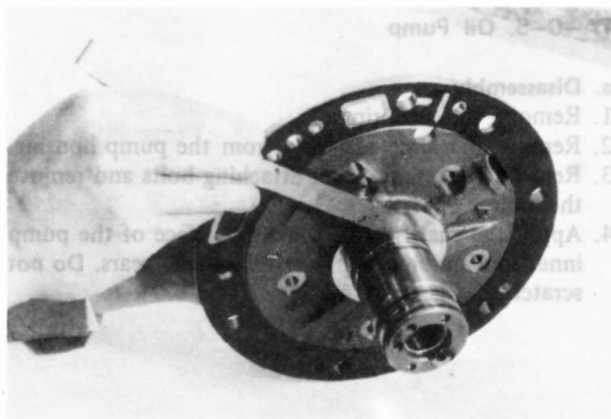

Fig. 7A-43

b. Checking

1. Inspect the pump housing and cover for damage.
2. Inspect the inner and outer gears for worn or damaged teeth.
3. Check the side clearance of the inner and outer gears, by using a straight edge and feeler gauge. If the clearance exceeds the limit, replace the outer and inner gears as a set.

Side clearance :

Standard 0.02 ~ 0.04 mm (0.001 ~ 0.002 in)
Limit 0.08 mm (0.003 in)

4. Check the clearance between the outer gear teeth and crescent. If the clearance exceeds the limit, replace the outer and inner gears as a set.

Clearance between the outer gear and crescent:

Standard 0.14 ~ 0.21 mm (0.006 ~ 0.008 in)
Limit 0.25 mm (0.010 in)

5. Check the clearance between the outer gear and housing. If the clearance exceeds the limit, replace the outer and inner gears as a set.

Clearance between the outer gear and housing:

Standard 0.05 ~ 0.20 mm (0.002 ~ 0.008 in)
Limit 0.25 mm (0.010 in)

6. Check the side clearance between the seal ring and ring groove. If the clearance is not within the specifications, replace the seal ring.

Side clearance:

0.04 ~ 0.16 mm (0.002 ~ 0.006 in)



Fig. 7A-44

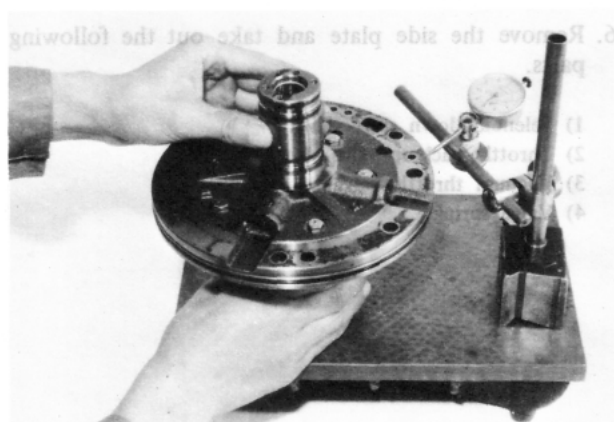

Fig. 7A-45

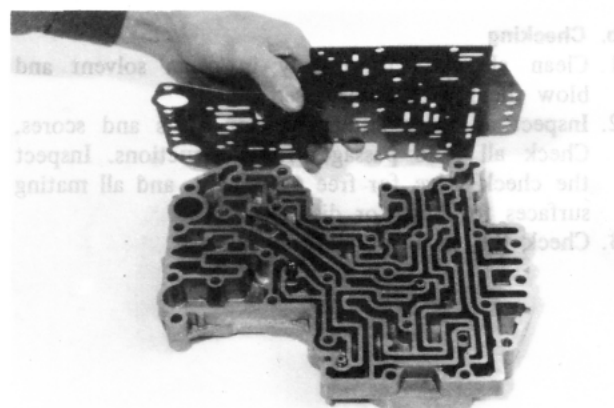

Fig. 7A-46

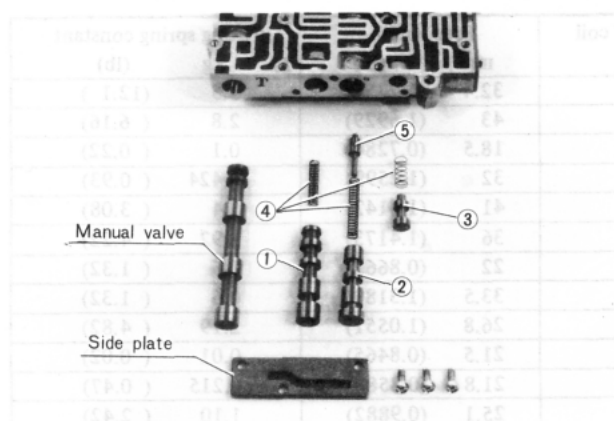

Fig. 7A-47

c. Assembly

Assemble the oil pump in the reverse order of disassembling.

Note the follows.

1. Discard the old seal ring and use **new** seal ring.
2. Before assembling, dip all parts in clean transmission fluid.
3. Install the inner and outer gears into the pump housing aligning the mating marks made during disassembly.
4. Install the pump housing on the **assembling guide** (49 2113 025A).

5. Position the pump cover onto the pump housing and temporarily tighten the attaching bolts.
6. Check the run-out of the oil pump cover with a dial indicator. If the run-out is not within the **0.07 mm (0.0028 in)**, adjust it by lightly tapping the cover with a plastic hammer.
7. Tighten the pump cover attaching bolts and recheck the run-out.

Pump cover tightening torque:

0.6 ~ 0.8 m-kg (4.3 ~ 5.8 ft-lb)

7A-C-6. Control Valve Body

a. Disassembly

1. Remove the oil strainer attaching bolts and remove the oil strainer.
2. Remove the valve body attaching bolts.
Separate the lower valve body, separator plate and upper valve body, being careful not to lose the check valves and springs in the lower valve body.

Note:

It is recommended to loosen the above attaching bolts with wrench.

3. Slide the manual valve off the body.
4. Remove the side plate and take out the following parts.

- 1) 1st-2nd shift valve
- 2) 2nd-3rd shift valve
- 3) Pressure modifier valve
- 4) Valve springs
- 5) 2nd-3rd shift plug

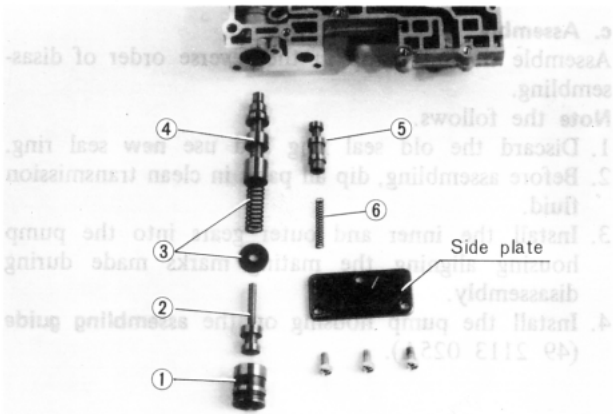

Fig.7A-48

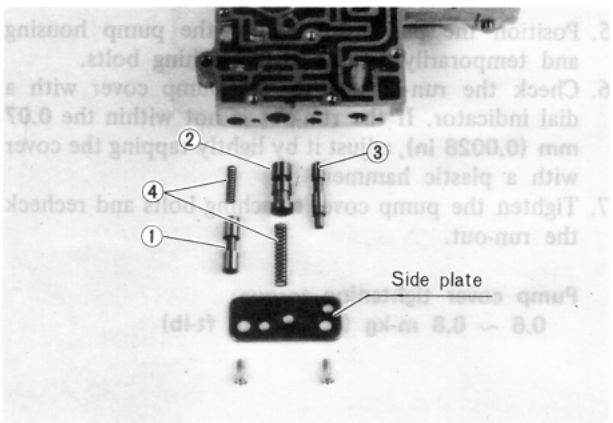

Fig. 7A-49

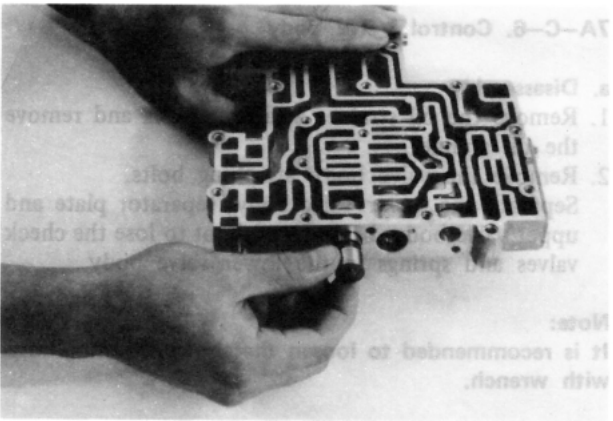

Fig. 7A-50

Valve spring specification

Valve spring	Coil outer dia.		Number of coil	Free length		Fitting spring constant	
	mm	(in)		mm	(in)	kg	(lb)
Manual detent	7.3	(0.2874)	15	32.4	(1.2756)	5.5	(12.1)
Pressure regulator	11.7	(0.4606)	13	43	(1.6929)	2.8	(6.16)
Pressure modifier	8.4	(0.3307)	5	18.5	(0.7284)	0.1	(0.22)
1st-2nd shift	6.55	(0.2579)	16.7	32	(1.2599)	0.424	(0.93)
2nd-3rd shift	6.9	(0.2717)	18	41	(1.6142)	1.4	(3.08)
Throttle back-up	7.3	(0.2874)	14	36	(1.4173)	1.92	(4.22)
Solenoid downshift	5.55	(0.2185)	12	22	(0.8662)	0.6	(1.32)
Second lock	5.55	(0.2185)	16	33.5	(1.3189)	0.6	(1.32)
Throttle relief	6.5	(0.2559)	14	26.8	(1.0551)	2.19	(4.82)
Orifice check	5.0	(0.1969)	15	21.5	(0.8465)	0.01	(0.02)
Primary governor	8.75	(0.3445)	5	21.8	(0.8583)	0.215	(0.47)
Secondary governor	9.2	(0.3622)	5.5	25.1	(0.9882)	1.10	(2.42)

5. Remove the side plate and pull out the following parts.

- 1) Pressure regulator sleeve
- 2) Pressure regulator plug
- 3) Spring seat/spring
- 4) Pressure regulator valve
- 5) Second lock valve
- 6) Spring

6. Remove the side plate and take out the following parts.

- 1) Selenoid down shift valve
- 2) Throttle back-up valve
- 3) Vacuum throttle valve
- 4) Valve springs

b. Checking

1. Clean all parts thoroughly in clean solvent and blow them with compressed air.
2. Inspect all valve and bores for burrs and scores. Check all fluid passages for obstructions. Inspect the check valve for free movement, and all mating surfaces for burrs or distortion.
3. Check the each spring for weakness.



Fig. 7A-44

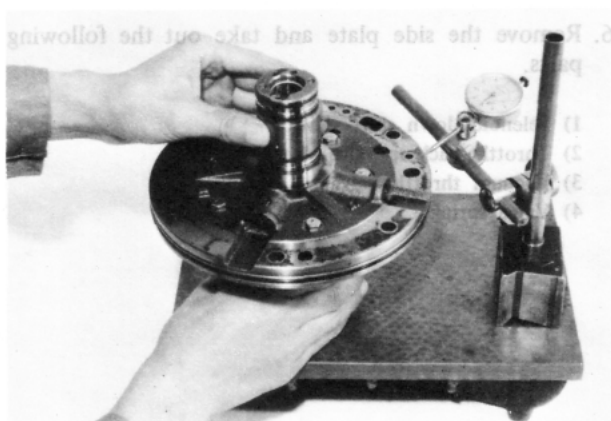

Fig. 7A-45

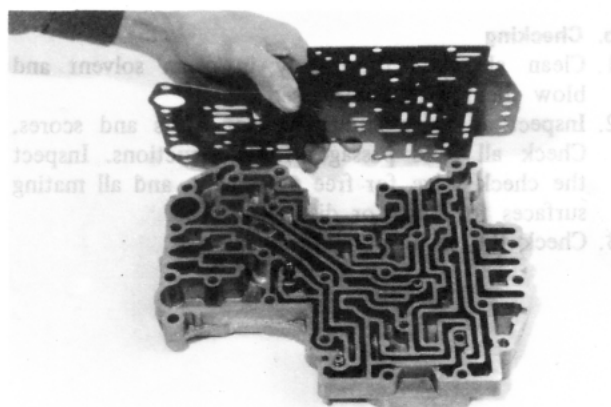

Fig. 7A-46

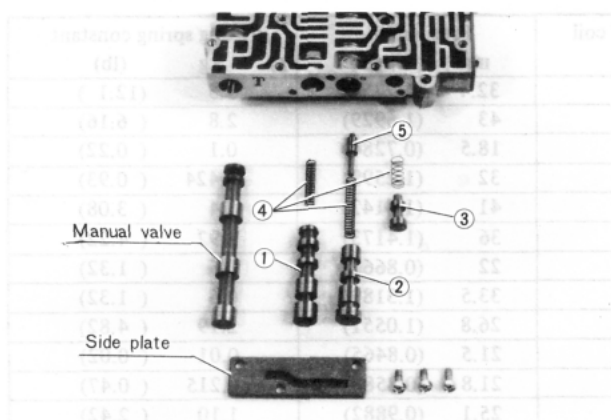

Fig. 7A-47

c. Assembly

Assemble the oil pump in the reverse order of disassembly.

Note the follows.

1. Discard the old seal ring and use **new** seal ring.
2. Before assembling, dip all parts in clean transmission fluid.
3. Install the inner and outer gears into the pump housing aligning the mating marks made during disassembly.
4. Install the pump housing on the **assembling guide** (49 2113 025A).

5. Position the pump cover onto the pump housing and temporarily tighten the attaching bolts.
6. Check the run-out of the oil pump cover with a dial indicator. If the run-out is not within the **0.07 mm (0.0028 in)**, adjust it by lightly tapping the cover with a plastic hammer.
7. Tighten the pump cover attaching bolts and recheck the run-out.

Pump cover tightening torque:

0.6 ~ 0.8 m·kg (4.3 ~ 5.8 ft·lb)

7A-C-6. Control Valve Body

a. Disassembly

1. Remove the oil strainer attaching bolts and remove the oil strainer.
2. Remove the valve body attaching bolts. Separate the lower valve body, separator plate and upper valve body, being careful not to lose the check valves and springs in the lower valve body.

Note:

It is recommended to loosen the above attaching bolts with wrench.

3. Slide the manual valve off the body.
4. Remove the side plate and take out the following parts.

- 1) 1st-2nd shift valve
- 2) 2nd-3rd shift valve
- 3) Pressure modifier valve
- 4) Valve springs
- 5) 2nd-3rd shift plug

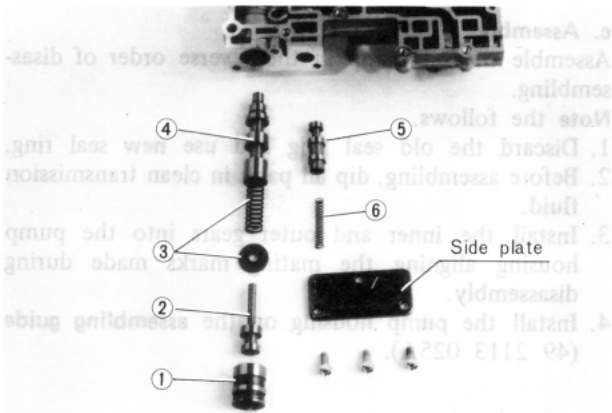

Fig. 7A-48

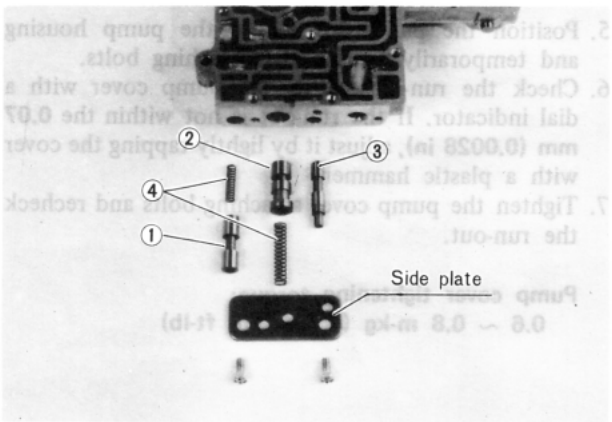

Fig. 7A-49

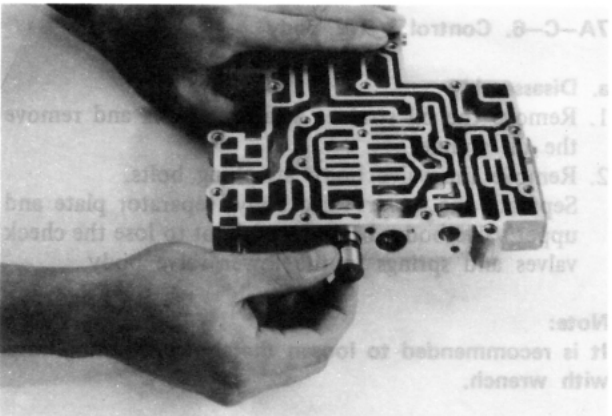

Fig. 7A-50

5. Remove the side plate and pull out the following parts.

- 1) Pressure regulator sleeve
- 2) Pressure regulator plug
- 3) Spring seat/spring
- 4) Pressure regulator valve
- 5) Second lock valve
- 6) Spring

6. Remove the side plate and take out the following parts.

- 1) Selenoid down shift valve
- 2) Throttle back-up valve
- 3) Vacuum throttle valve
- 4) Valve springs

b. Checking

1. Clean all parts thoroughly in clean solvent and blow them with compressed air.
2. Inspect all valve and bores for burrs and scores. Check all fluid passages for obstructions. Inspect the check valve for free movement, and all mating surfaces for burrs or distortion.
3. Check the each spring for weakness.

Valve spring specification

Valve spring	Coil outer dia.		Number of coil	Free length		Fitting spring constant	
	mm	(in)		mm	(in)	kg	(lb)
Manual detent	7.3	(0.2874)	15	32.4	(1.2756)	5.5	(12.1)
Pressure regulator	11.7	(0.4606)	13	43	(1.6929)	2.8	(6.16)
Pressure modifier	8.4	(0.3307)	5	18.5	(0.7284)	0.1	(0.22)
1st-2nd shift	6.55	(0.2579)	16.7	32	(1.2599)	0.424	(0.93)
2nd-3rd shift	6.9	(0.2717)	18	41	(1.6142)	1.4	(3.08)
Throttle back-up	7.3	(0.2874)	14	36	(1.4173)	1.92	(4.22)
Solenoid downshift	5.55	(0.2185)	12	22	(0.8662)	0.6	(1.32)
Second lock	5.55	(0.2185)	16	33.5	(1.3189)	0.6	(1.32)
Throttle relief	6.5	(0.2559)	14	26.8	(1.0551)	2.19	(4.82)
Orifice check	5.0	(0.1969)	15	21.5	(0.8465)	0.01	(0.02)
Primary governor	8.75	(0.3445)	5	21.8	(0.8583)	0.215	(0.47)
Secondary governor	9.2	(0.3622)	5.5	25.1	(0.9882)	1.10	(2.42)

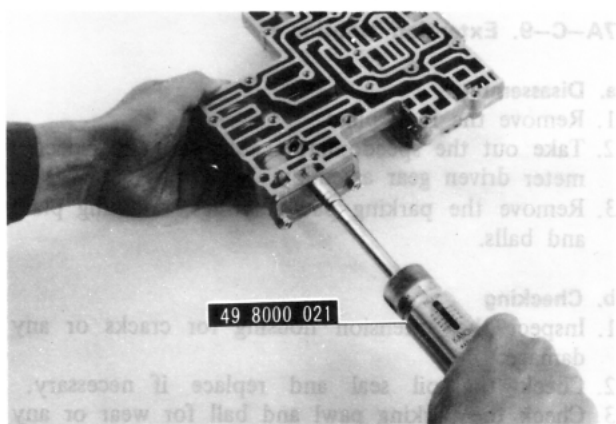

Fig. 7A-51



Fig. 7A-52

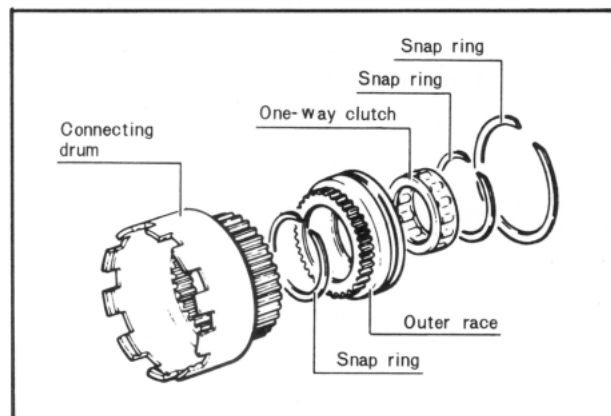

Fig. 7A-53



Fig. 7A-54

c. Assembly

Assemble the control valve body in the reverse order of disassembling.

Note the follows:

1. Before installing, dip all parts in clean transmission fluid.
2. Tighten the screws by using the **torque driver** (49 8000 021).

Tightening torque:

0.25 ~ 0.35 m-kg (1.8 ~ 2.5 ft-lb)

Reamer bolts tightening torque:

0.5 ~ 0.7 m-kg (3.6 ~ 5.1 ft-lb)

7A-C-7. Planet Carrier

Checking

Check the clearance between pinion washer and planetary carrier with a feeler gauge.

If the clearance exceeds the limit, replace the carrier as a unit.

Clearance:

Standard 0.2 ~ 0.7 mm (0.008 ~ 0.028 in)

Limit 0.8 mm (0.031 in)

7A-C-8. One-way Clutch

a. Disassembly

1. Remove the snap rings and remove the one-way clutch from the outer race.
2. Remove the large snap ring and remove the outer race from the connecting drum.

b. Checking

1. Inspect the outer and inner races for scores or damaged surface area where the rollers contact the races.
2. Inspect the rollers for excessive wear or damage.

c. Assembly

Assemble the one-way clutch in the reverse order of disassembling.

Be sure the arrow mark on the one-way clutch is toward the front of the vehicle.

The one-way clutch should be free to rotate only in clockwise direction.

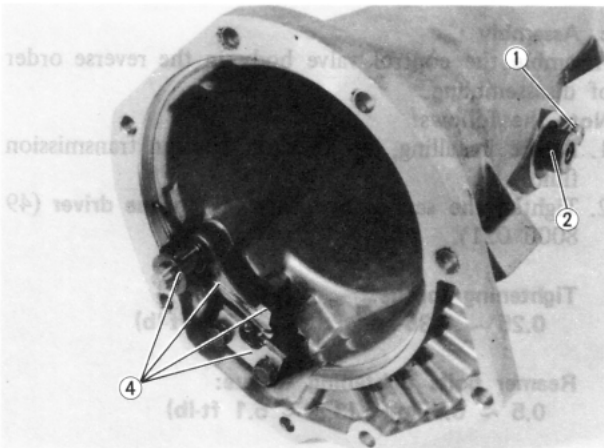

Fig. 7A-55

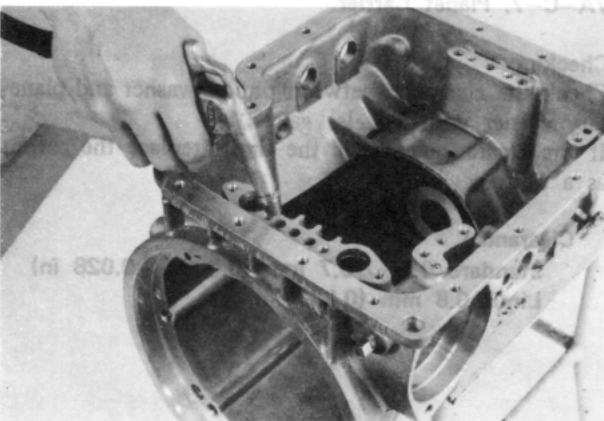

Fig. 7A-56

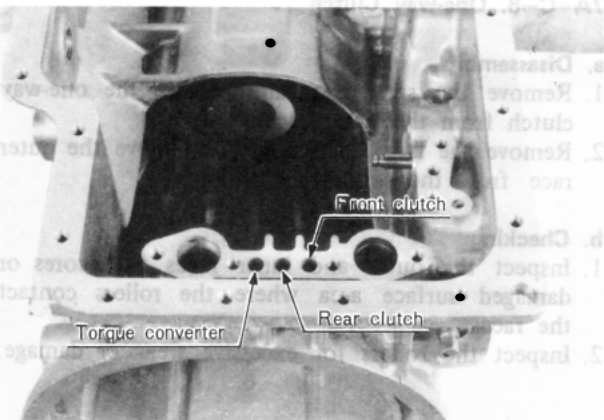

Fig. 7A-57

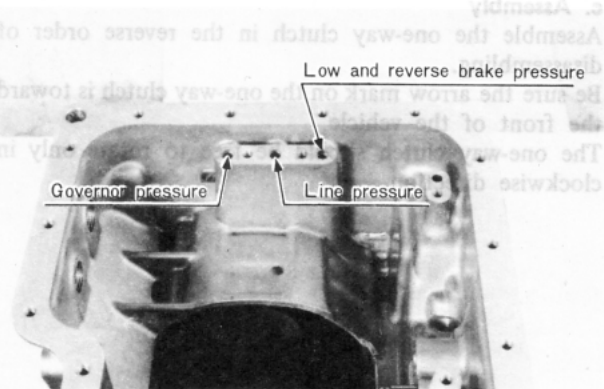

Fig. 7A-58

7A-C-9. Extension Housing

a. Disassembly

1. Remove the lock plate.
2. Take out the speedometer cable joint and speedometer driven gear assembly.
3. Remove the parking pawl, springs, retaining plate and balls.

b. Checking

1. Inspect the extension housing for cracks or any damage.
2. Check the oil seal and replace if necessary.
3. Check the parking pawl and ball for wear or any damage.

7A-C-10. Transmission Case

Thoroughly clean the transmission case and dry it with compressed air.

Inspect the case for cracks and machined surfaces for burrs, nicks or any damage.

Check each oil passage of the case for clog by blowing the compressed air to the passages.

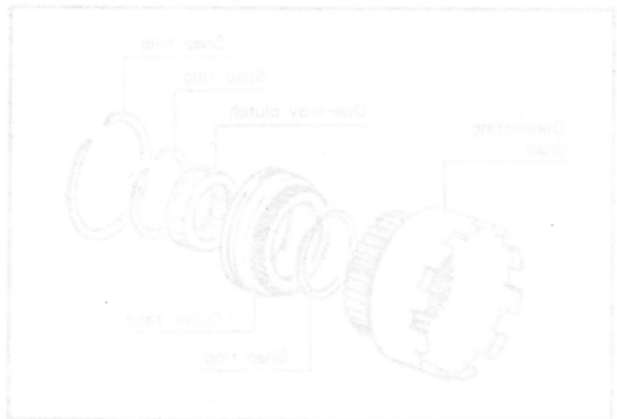

Fig. 7A-59



Fig. 7A-60

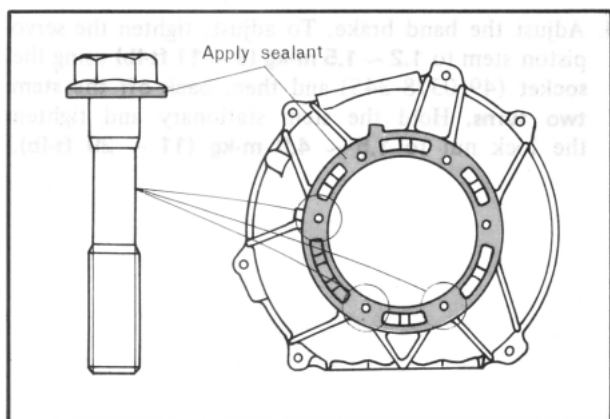

Fig. 7A-59

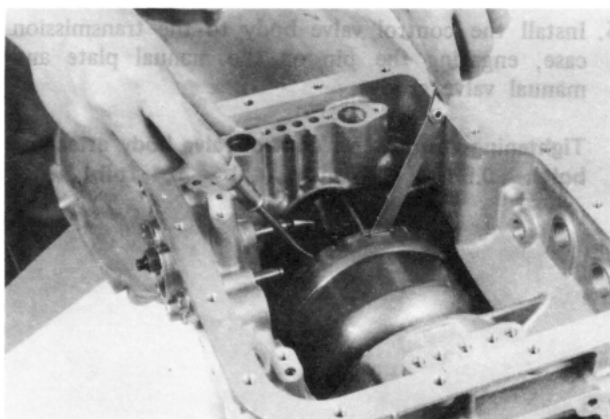

Fig. 7A-60

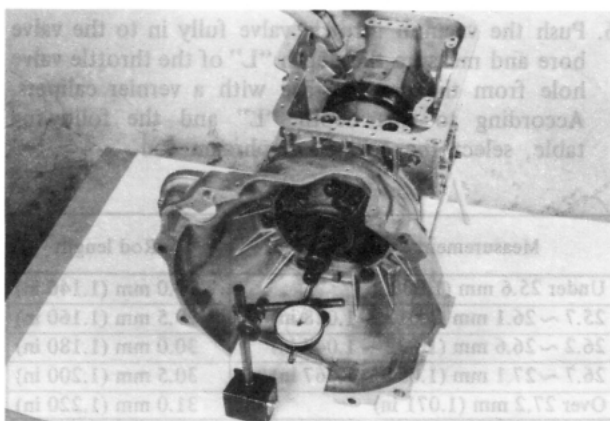

Fig. 7A-61

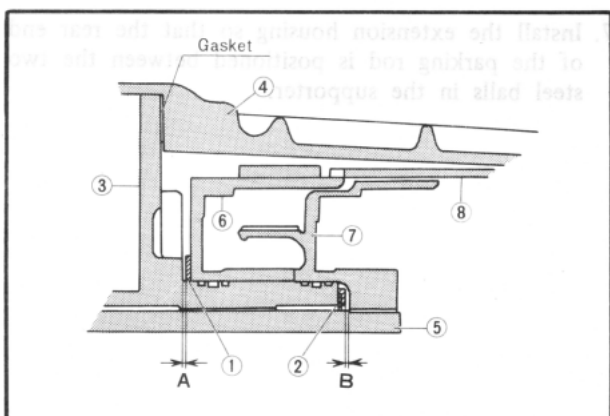

Fig. 7A-62

7A-D. TRANSMISSION ASSEMBLY

Assemble the transmission in the reverse order of disassembling, noting the following points.

1. Apply the sealant on the mounting surface of the converter housing and three attaching bolt flanges.

Tightening torque of converter attaching bolts:
4.5 ~ 5.5 m·kg (33 ~ 40 ft·lb)

2. Check the end play of the front clutch drum by checking the clearance between the front clutch drum and connecting shell using a feeler gauge. If the end play is not within the specifications, select and install the correct thrust washer (See Fig. 7A-62 ①).

End play: 0.5 ~ 0.8 mm (0.020 ~ 0.031 in)

Available thrust washers

1.5 mm (0.059 in)	2.3 mm (0.091 in)
1.7 mm (0.067 in)	2.5 mm (0.098 in)
1.9 mm (0.075 in)	2.7 mm (0.106 in)
2.1 mm (0.083 in)	

3. Check the total end play with a dial indicator. To check, insert a screwdriver behind of the connecting shell, and move the connecting shell fore and aft and take a indicator reading on the input shaft. If the total end play is not within the specifications, select and install the correct bearing race (See Fig. 7A-62 ②).

Total end play: 0.25 ~ 0.50 mm (0.01 ~ 0.02 in)

Available bearing races

1.2 mm (0.047 in)	1.8 mm (0.071 in)
1.4 mm (0.055 in)	2.0 mm (0.079 in)
1.6 mm (0.063 in)	2.2 mm (0.087 in)

A: Front clutch drum end play

B: Total end play

- 1) Front clutch thrust washer
- 2) Oil pump cover bearing race
- 3) Oil pump
- 4) Transmission case
- 5) Input shaft
- 6) Front clutch
- 7) Rear clutch
- 8) Connecting shell

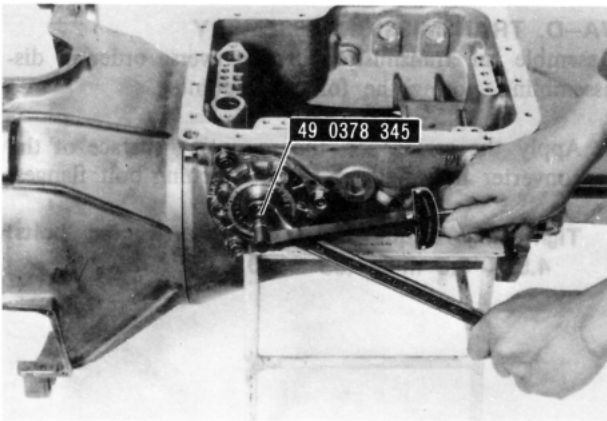

Fig. 7A-63

- Adjust the band brake. To adjust, tighten the servo piston stem to **1.2 ~ 1.5 m-kg (9 ~ 11 ft-lb)** using the socket (49 0378 345) and then, **back off the stem two turns**. Hold the stem stationary and tighten the lock nut to **1.5 ~ 4.0 m-kg (11 ~ 29 ft-lb)**.

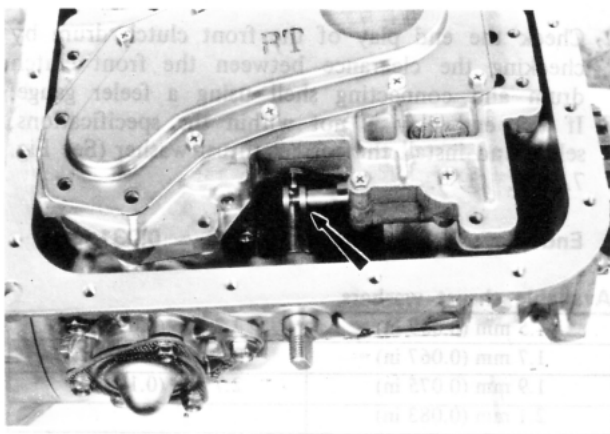

Fig. 7A-64

- Install the control valve body to the transmission case, engaging the pin on the manual plate and manual valve groove.

Tightening torque of control valve body attaching bolts: 0.55 ~ 0.75 m-kg (4.0 ~ 5.4 ft-lb).

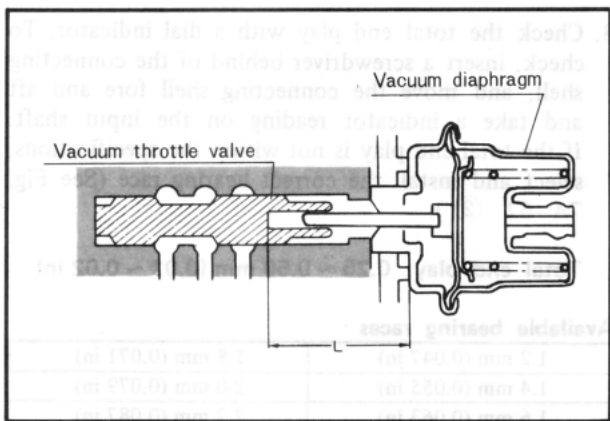

Fig. 7A-65

- Push the vacuum throttle valve fully in to the valve bore and measure the depth "L" of the throttle valve hole from the case surface with a vernier calipers. According to this depth "L" and the following table, select the correct diaphragm rod.

Measurement depth "L"	Rod length
Under 25.6 mm (1.008 in)	29.0 mm (1.140 in)
25.7 ~ 26.1 mm (1.012 ~ 1.028 in)	29.5 mm (1.160 in)
26.2 ~ 26.6 mm (1.032 ~ 1.047 in)	30.0 mm (1.180 in)
26.7 ~ 27.1 mm (1.051 ~ 1.067 in)	30.5 mm (1.200 in)
Over 27.2 mm (1.071 in)	31.0 mm (1.220 in)

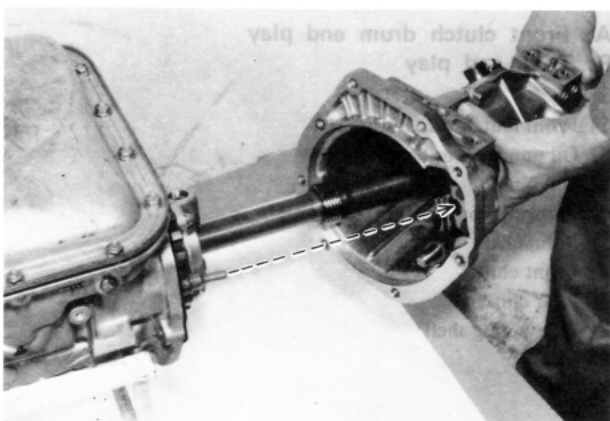

Fig. 7A-66

- Install the extension housing so that the rear end of the parking rod is positioned between the two steel balls in the supporter.



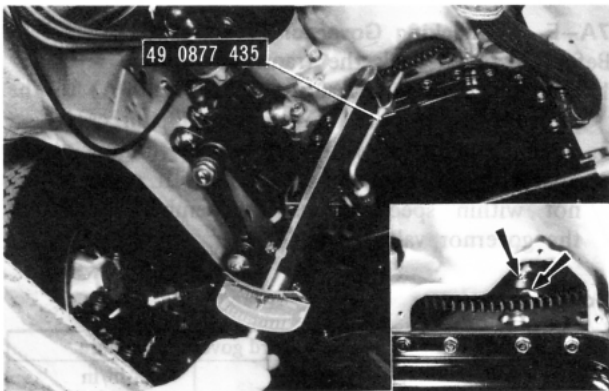

Fig. 7A-67

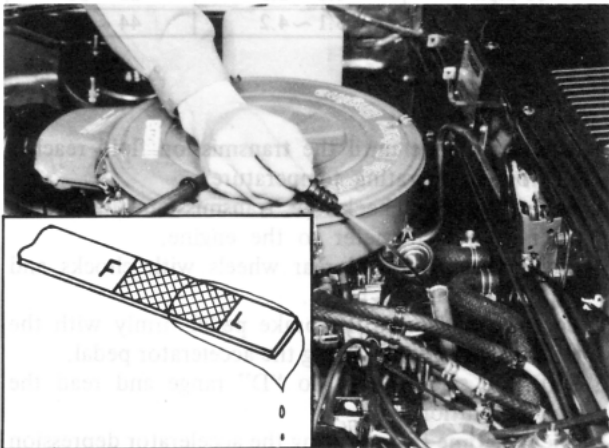

Fig. 7A-68

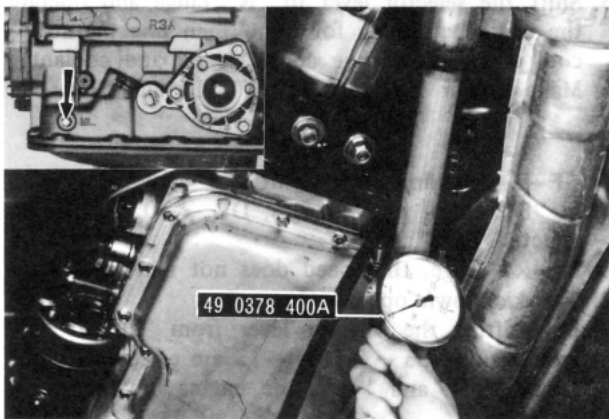

Fig. 7A-69

Line pressure

Manual Range	Engine idling condition	Engine stall condition
"R"	4.0 ~ 7.0 kg/cm ² (57 ~ 100 lb/in ²)	16.0 ~ 19.0 kg/cm ² (228 ~ 270 lb/in ²)
"D"	3.0 ~ 4.0 kg/cm ² (43 ~ 57 lb/in ²)	9.0 ~ 11.0 kg/cm ² (128 ~ 156 lb/in ²)
"2"	8.0 ~ 12.0 kg/cm ² (114 ~ 171 lb/in ²)	8.0 ~ 12.0 kg/cm ² (114 ~ 171 lb/in ²)
"1"	3.0 ~ 4.0 kg/cm ² (43 ~ 57 kg/cm ²)	9.0 ~ 11.0 kg/cm ² (128 ~ 156 lb/in ²)

7A-E. TRANSMISSION INSTALLATION

Install the transmission in the reverse order of removing. **Note** the follows:

1. Align the mating marks painted on the torque converter and drive plate during disassembly process. Tighten the bolts attaching the converter-to-drive plate to 3.5 ~ 5.0 m·kg (25 ~ 36 ft·lb).
2. Fill the transmission to the proper fluid level with the specified fluid.
3. Perform the stall test, road test and hydraulic test.

7A-F. HYDRAULIC CONTROL INSPECTION

7A-F-1. Checking Transmission Fluid Level

1. Make sure the vehicle is on the level ground. Then firmly apply the parking brake.
2. Warm up the engine to the normal operating temperature. The engine idling conditions are stabilized.
3. Shift the selector lever through all of the drive positions and place the lever to "P" position. Do not stop the engine during the fluid level checks.
4. Wipe any dirt from the dipstick cap, pull out the dipstick, wipe clean and reinsert fully.
5. Pull out again, and check the level. The fluid level should be maintained between the "L" and "F" marks on the gauge.

7A-F-2. Checking Line Pressure

1. Run the engine until the transmission fluid reaches its normal operating temperature. Before testing, make sure that the transmission fluid level and engine idle speed are within the specifications.
2. Install the **pressure gauge** (49 0378 400A) to the pressure outlet port at the right rear of the transmission case. Be sure to place the gauge where it is visible from the driver's seat.
3. Block the front and rear wheels with chocks and apply the parking brake. Be sure to depress the brake pedal firmly with the left foot before depressing the accelerator pedal.
4. Shift the selector lever into the "D" range. Run the engine at idling speed and read the pressure gauge.
5. Slowly depress the accelerator pedal until the throttle valve is fully opened. While checking whether the pressure rises smoothly, read the pressure gauge at the stall condition. The test time from starting accelerator depression to its release **must not exceed 5 seconds**.
6. Shift the selector lever to "N" range and operate the engine at idling for **more than one minute** to cool down the torque converter oil and coolant.
7. Measure line pressure for each range in the same manner.

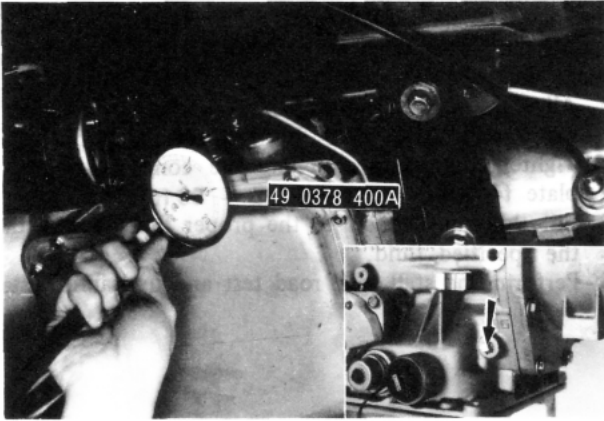

Fig. 7A-70

Stall revolution

Before break in	After break in
2,250 ~ 2,500 rpm	2,300 ~ 2,550 rpm

Shift point speeds

Throttle condition	Gear shift	Vehicle speed mph
Wide open throttle (Kick-down) (0 ~ 100 mm-Hg) (0 ~ 3.94 in-Hg)	D1 → D2	32 ~ 45
	D2 → D3	59 ~ 77
	D3 → D2	51 ~ 65
	D2 → D1	14 ~ 30
Half throttle (200 ± 10 mm-Hg) (7.87 ± 0.39 in-Hg)	D1 → D2	9 ~ 21
	D2 → D3	18 ~ 40
Fully closed throttle	D3 → D1	6 ~ 12
Manual "1"	12 → 11	24 ~ 33

7A-F-3. Checking Governor Pressure

Before testing, check the transmission fluid level.

1. Connect a **pressure gauge** (49 0378 400A) to the pressure outlet port on the transmission case.
2. Read the pressure with the vehicle running at the speeds specified in the table below. If pressures are not within specifications, disassemble and check the governor valve.

Governor pressure

Vehicle speed	Standard governor pressure	
	kg/cm ²	lb/in
20 mph	0.8 ~ 1.3	11 ~ 18
35 mph	1.6 ~ 2.3	23 ~ 33
55 mph	3.1 ~ 4.2	44 ~ 60

7A-F-4. Stall Test

1. Run the engine until the transmission fluid reaches its normal operating temperature.
Before testing, check the transmission fluid level.
2. Connect a tachometer to the engine.
3. Block the front and rear wheels with chocks and apply the parking brake.
Be sure to depress the brake pedal firmly with the left foot before depressing the accelerator pedal.
4. Shift the selector lever to "D" range and read the stall revolution.
The test time from starting the accelerator depression to its release **must not exceed 5 seconds**.
5. Shift the selector lever to "N" range and operate the engine at idling for **more than one minute** to cool down the torque converter oil and coolant.
6. Make similar stall tests in "2", "1" and "R".

7A-F-5. Checking Shift Point

1. In "D" range, gear changes, D₁ → D₂ → D₃ are effected.
In "R" range, the speed does not increase.
2. The kickdown operates properly.
3. By shifting the selector lever from "D" to "1", gear changes D₃ → 2 (1₂) → 1₁ are effected. In the ranges "1₂" and "1₁", the engine braking works properly.
4. In "1" range, the speed does not increase.
5. In "2" range, the gear fixed at 2 range.
6. In "P" range, vehicle can be parked properly.
7. Check the shift points according to the specifications.

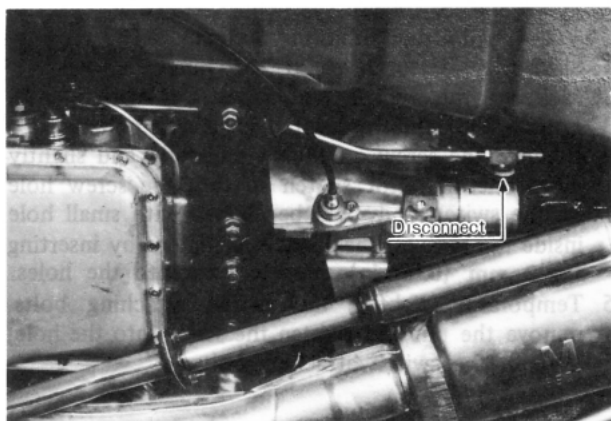

Fig. 7A-71

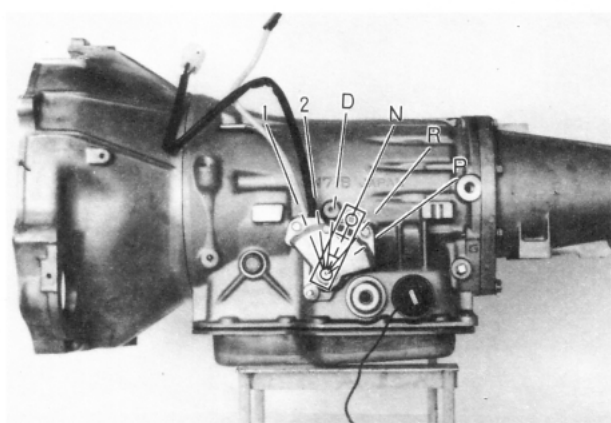

Fig. 7A-72

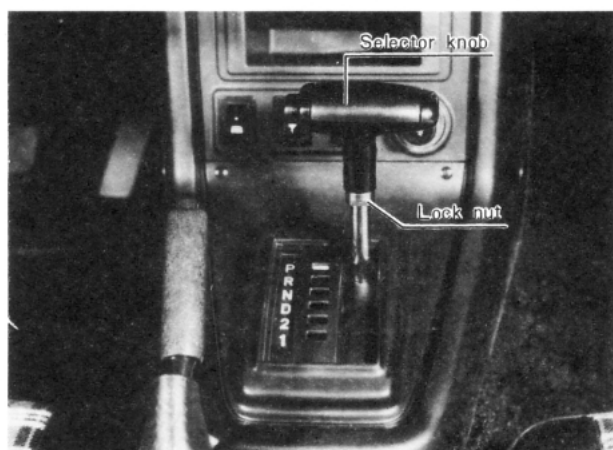

Fig. 7A-73

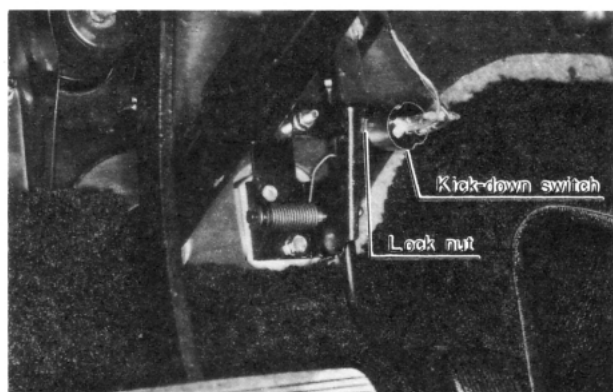

Fig. 7A-74

7A-G. SHIFT CONTROL LINKAGE

Before the linkage is adjusted, be sure the engine idle speed is properly adjusted.

7A-G-1. Adjusting Manual Linkage

1. Shift the selector lever to "N" position.
2. Raise the vehicle and support it with stands.
3. Disconnect the T-joint from the lower end of the selector lever operating arm.
4. Move the transmission selector range lever to the "N" position, third detent position from the rear side of the transmission.
5. Loosen the T-joint attaching nuts and adjust the T-joint so that it freely enters the hole of the selector lever operating arm. Tighten the attaching nuts.
6. Connect the T-joint to the selector lever operating arm and secure the T-joint.
7. Lower the vehicle and check the operation of the transmission in each selector lever position.

7A-G-2. Adjusting Selector Lever Knob

1. Position the selector lever to "N" or "D" range.
2. Loosen the lock nut of the selector lever knob and lightly screw in the selector lever knob in its fully stroke.
3. Screw out the selector lever knob one turn so that the push button faces to driver's side.
4. Push the push button and confirm that the selector lever can be shifted to "P" range.
If the selector lever cannot be shifted to "P" range, screw in the selector lever knob by one turn.
5. Confirm that the selector lever cannot, without pushing the push button, be shifted from "N" to "R" or from D to "2" range.
If the selector lever can be shifted to "R" or "2" range without pushing the push button, screw out the knob.
6. Tighten the lock nut to 1.5 ~ 2.0 m-kg (10.8 ~ 14.5 ft-lb).
7. Operate the ignition switch and make sure that the starting motor operates only at "N" and "P" position.

7A-G-3. Adjusting Kick-down Switch

1. Disconnect the wiring connectors from the kick-down switch.
2. Loosen the lock nut and screw out the kick-down switch for few turns.
3. Fully depress the accelerator pedal.
4. Gradually screw in the kick-down switch until the clicking sound is audible and then further screw in the switch half turn.
5. Tighten the lock nut and connect the wiring connectors.

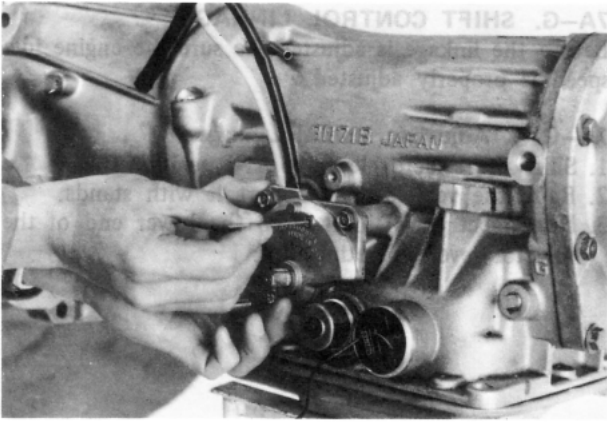

Fig. 7A-75

4. Move the transmission selector lever to the "N" position, third detent position from the rear side of the transmission.

5. Loosen the T-joint attaching nut and adjust the T-joint so that it freely enters the hole of the selector lever operating arm. Tighten the attaching nut.

6. Connect the T-joint to the selector lever operating arm and secure the T-joint.

7. Lower the vehicle and check the operation of the transmission in each selector lever position.

7A-G-2. Adjusting Selector Lever Knob

1. Position the selector lever to "N" or "D" range.

2. Loosen the lock nut of the selector lever knob and lightly screw in the selector lever knob in its fully stroke.

3. Screw out the selector lever knob one turn so that the push button faces to driver's side.

4. Push the push button and confirm that the selector lever can be shifted to "P" range.

5. If the selector lever cannot be shifted to "P" range, screw in the selector lever knob by one turn.

6. Confirm that the selector lever cannot, without pushing the push button, be shifted from "N" or "R" or from "D" to "L" range.

7. If the selector lever can be shifted to "K" or "H" range without pushing the push button, screw out the knob.

8. Tighten the lock nut to 7.8 - 9.0 m·kg (10.8 - 14.5 ft·lb).

9. Operate the ignition switch and make sure that the starting motor operates only at "N" and "P" position.

7A-G-3. Adjusting Kick-down Switch

1. Disconnect the wiring connector from the kick-down switch.

2. Loosen the lock nut and screw out the kick-down switch for few turns.

3. Fully depress the accelerator pedal.

4. Gradually screw in the kick-down switch until the clicking sound is audible and then further screw in the switch half turn.

5. Tighten the lock nut and connect the wiring connector.

7A-G-4. Adjusting Inhibitor Switch

1. Shift the selector lever to "N" range.
2. Jack up the vehicle and support it with stands.
3. Loosen the inhibitor switch attaching bolts.
4. Remove the screw on the switch body and slightly move the inhibitor switch so that the screw hole on the switch body will be aligned with small hole inside the switch. Check their alignment by inserting a 2.0 mm (0.08 in) diameter pin into the holes.
5. Temporarily tighten the switch attaching bolts, remove the pin and tighten the screw into the hole.
6. Tighten the switch attaching bolts.



Fig. 7A-76



Fig. 7A-77



Fig. 7A-78