



This document is brought to you through the kind services of

**Kevin Wright**

[krwright@wankel.net](mailto:krwright@wankel.net)

<http://www.wankel.net/~krwright>

who, well, didn't do much this time, since Paul Lee provided the thing already scanned and compiled into a PDF! (Thanks!). Go visit his website: <http://www.iluvmyrx7.com/index.htm> Lots of RX-7 goodness there.

There are several ways to get around in the document. I have provided Bookmarks to all the sections, and thumbnails are also provided in the Thumbnails side bar.

I have also included a label for the spine of a binder, for those who wish to print out all the pages and keep a dead-tree edition handy.☺

The original document is © 1979 Toyo Kogyo Co., Ltd., and remains so. This version is provided as a service for owners of first generation Mazda RX-7s who are having a devil of a time locating the factory service manual for a reasonable price.

If you really want to send me money, email me and I'll tell you where to send it, but it's not necessary. Consider this payback for all the good advice and information gleaned from the various RX-7 email lists!

Subscribe to the Early Mazda Rotaries email list:

Send an email with "subscribe" (without the quotes) to [list-request@sa22c.org](mailto:list-request@sa22c.org)

See <http://www.dfw-rx7.com> for information on the DFW-RX7 email list.

09/16/03

# CLUTCH

6-A. CLUTCH REMOVAL . . . . .	6 : 1
6-B. CLUTCH INSPECTION . . . . .	6 : 2
6-B-1. Checking Release Fork and Bearing . . . . .	6 : 2
6-B-2. Checking Pressure Plate and Cover Assembly . . . . .	6 : 2
6-B-3. Checking Clutch Disc . . . . .	6 : 2
6-B-4. Checking Flywheel . . . . .	6 : 2
6-B-5. Replacing Ring Gear . . . . .	6 : 3
6-B-6. Checking Eccentric Shaft Rear Oil Seal . . . . .	6 : 3
6-B-7. Checking Needle Bearing (Pilot bearing) . . . . .	6 : 3
6-C. CLUTCH INSTALLATION . . . . .	6 : 4
6-D. CLUTCH PEDAL ADJUSTMENT . . . . .	6 : 4
6-E. CLUTCH MASTER CYLINDER . . . . .	6 : 5
6-E-1. Removing Clutch Master Cylinder . . . . .	6 : 5
6-E-2. Disassembling Clutch Master Cylinder . . . . .	6 : 5
6-E-3. Checking Clutch Master Cylinder . . . . .	6 : 5
6-E-4. Assembling Clutch Master Cylinder . . . . .	6 : 6
6-E-5. Installing Clutch Master Cylinder . . . . .	6 : 6
6-F. CLUTCH RELEASE CYLINDER . . . . .	6 : 6
6-F-1. Removing Clutch Release Cylinder . . . . .	6 : 6
6-F-2. Disassembling Clutch Release Cylinder . . . . .	6 : 6
6-F-3. Checking Clutch Release Cylinder . . . . .	6 : 6
6-F-4. Assembling Clutch Release Cylinder . . . . .	6 : 7
6-F-5. Installing Clutch Release Cylinder . . . . .	6 : 7
6-G. AIR BLEEDING . . . . .	6 : 7

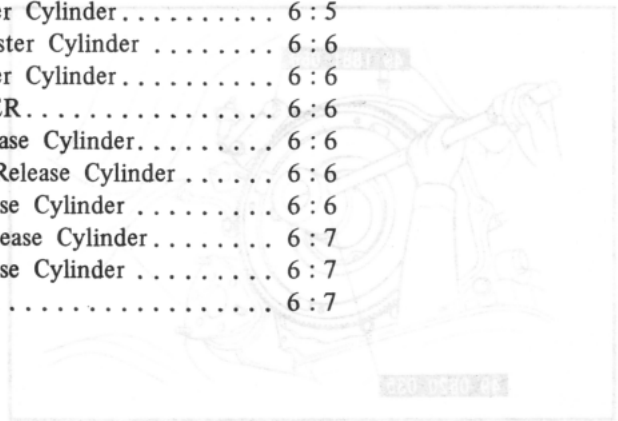
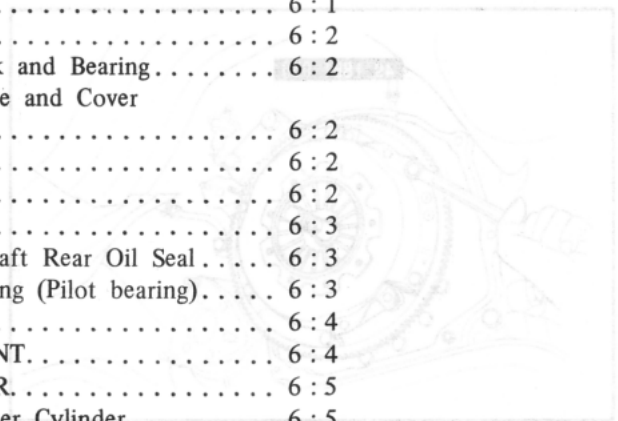

8-A. CLUTCH REMOVAL  
 1. Remove the transmission as described in Part 7, A.  
 2. Remove the release fork and release bearing.

6-B-1. Checking Release Fork and Bearing  
 6-B-2. Checking Pressure Plate and Cover Assembly  
 6-B-3. Checking Clutch Disc  
 6-B-4. Checking Flywheel  
 6-B-5. Replacing Ring Gear  
 6-B-6. Checking Eccentric Shaft Rear Oil Seal  
 6-B-7. Checking Needle Bearing (Pilot bearing)

6-E-1. Removing Clutch Master Cylinder  
 6-E-2. Disassembling Clutch Master Cylinder  
 6-E-3. Checking Clutch Master Cylinder  
 6-E-4. Assembling Clutch Master Cylinder  
 6-E-5. Installing Clutch Master Cylinder  
 6-F-1. Removing Clutch Release Cylinder  
 6-F-2. Disassembling Clutch Release Cylinder  
 6-F-3. Checking Clutch Release Cylinder  
 6-F-4. Assembling Clutch Release Cylinder  
 6-F-5. Installing Clutch Release Cylinder

Remove the flywheel with the puller (49 0823 300A) turning the puller handle and lightly hitting the puller head.  
 Be careful not to drop the flywheel.

Note:  
 After removing the flywheel, inspect for oil leaking through the eccentric shaft rear oil seal.

Fig. 6-1

Fig. 6-2

Fig. 6-3

Fig. 6-4

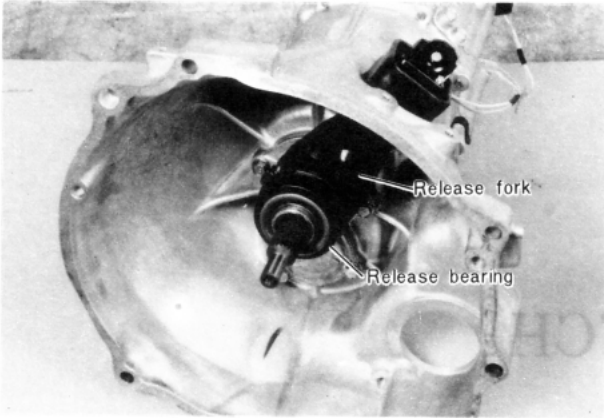

Fig. 6-1

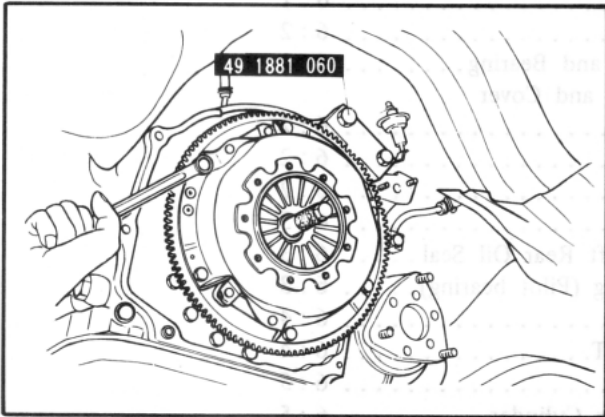

Fig. 6-2

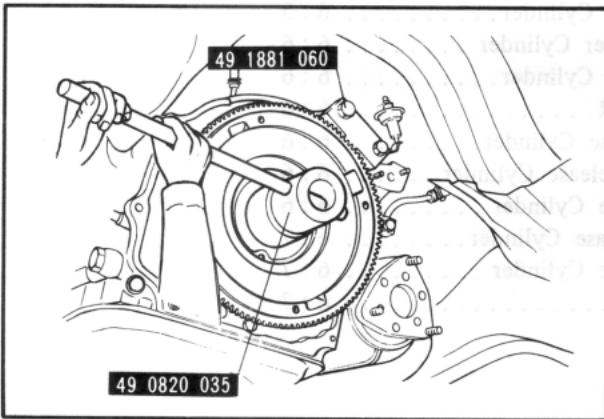

Fig. 6-3

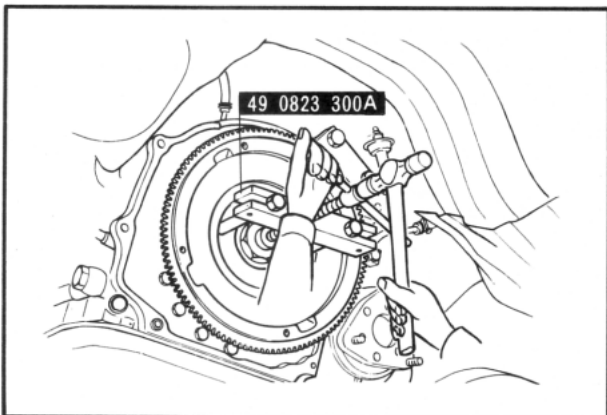

Fig. 6-4

### 6-A. CLUTCH REMOVAL

1. Remove the transmission as described in Par. 7-A.
2. Remove the release fork and release bearing.

3. Lock the flywheel with the **brake** (49 1881 060).
4. Remove the clutch pressure plate and cover assembly, and clutch disc.

**Note :**

Take care not to get oil or grease on the clutch disc linings, and the pressure plate and flywheel surface that contact on the clutch disc.

5. Loosen the lock nut by using the **box wrench** (49 0820 035).

6. Remove the flywheel with the **puller** (49 0823 300A), turning the puller handle and lightly hitting the puller head.  
Be careful not to drop the flywheel.

**Note :**

After removing the flywheel, inspect for oil leaking through the eccentric shaft rear oil seal.



Fig. 6-5

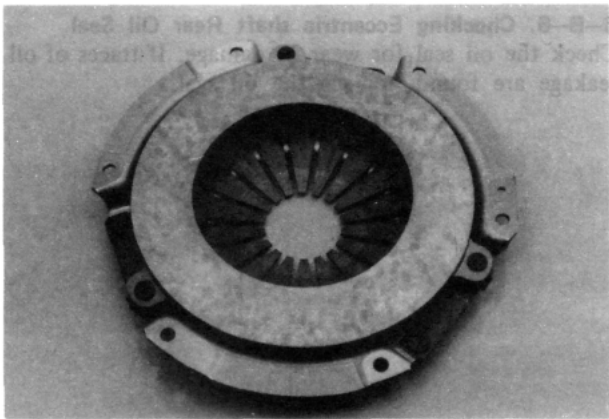

Fig. 6-6

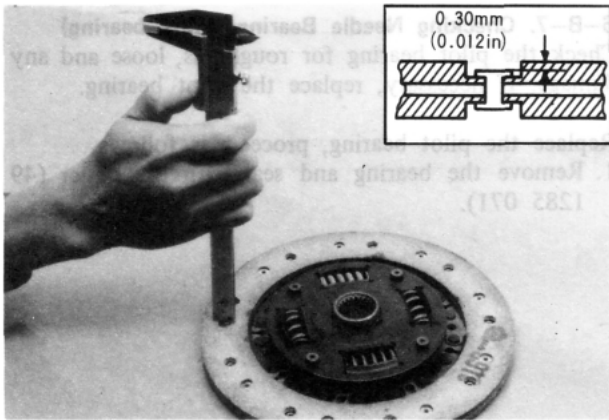

Fig. 6-7

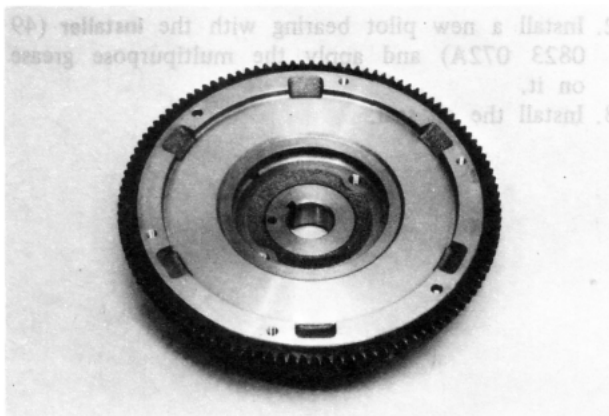

Fig. 6-8

## 6-B. CLUTCH INSPECTION

### 6-B-1. Checking Release Fork and Bearing

#### Note :

The release bearing is pre-lubricated and must not be washed with gasoline or any other solvent.

Check the release bearing by pressing and turning the front race slowly by hand. Replace if the bearing feels rough or seems noisy when turning.

Check the release fork for crack or bend. If necessary, replace the release fork.

### 6-B-2. Checking Pressure Plate and Cover Assembly

Check the contact surface of the pressure plate for wear, damage or warp.

If the warp is slight, correct it by lapping with compound or by turning a lathe. But if they are severe, replace with a new one.

Check the diaphragm spring and cover and if any wear or damage is found, replace the pressure plate and cover assembly.

### 6-B-3. Checking Clutch Disc

Inspect the clutch disc for worn or loose facing, distortion, loose rivets at the hub, and for broken springs.

**Rivet head depth limit: 0.3 mm (0.012 in)**

**Run-out limit: 1.0 mm (0.039 in)**

If oil is evident on the facing, clean or replace the clutch disc and eliminate the cause of oil leakage. Make certain that the clutch disc slides easily on the main drive shaft without any excessive play.

### 6-B-4. Checking Flywheel

Inspect the contact surface of the flywheel with the clutch facing for burnt surface, scored surface or rivet grooves.

If it is slight, it can be reconditioned by grinding or by turning a lathe. If the damage is deep, the flywheel should be replaced.

Check the ring gear teeth and replace if the ring gear teeth are broken, cracked or seriously burred.



Fig. 6-9

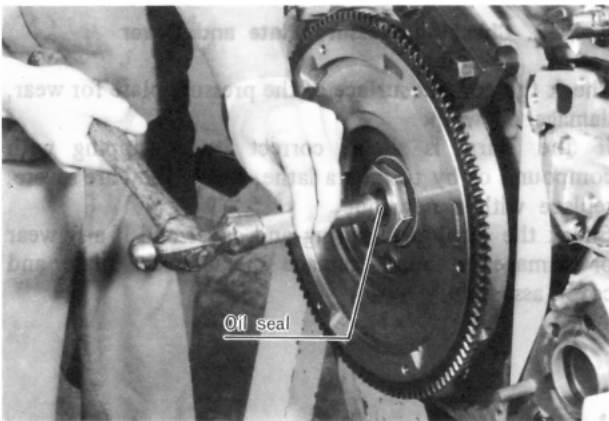

Fig. 6-10

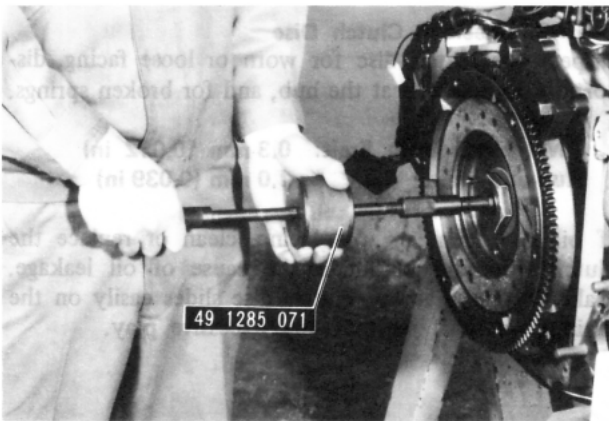

Fig. 6-11

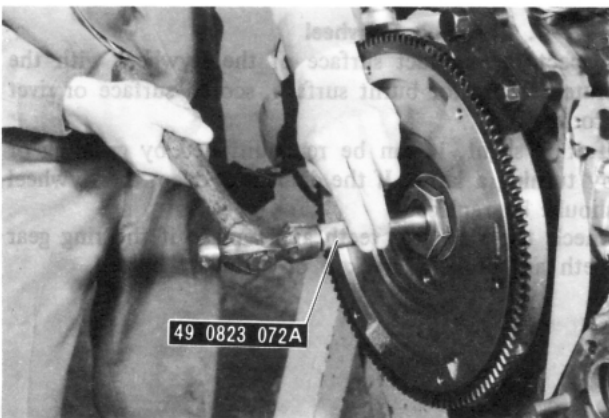

Fig. 6-12

#### 6-B-5. Replacing Ring Gear

1. Heat the old ring gear and remove it from the flywheel.
2. Heat a new ring gear evenly  $250 \sim 300^{\circ}\text{C}$  ( $480 \sim 570^{\circ}\text{F}$ ).
3. Place the ring gear on the cold flywheel, making sure that the **chamfer on the teeth is faced to the transmission**.
4. Allow the ring gear to cool slowly to shrink it onto the flywheel.

#### 6-B-6. Checking Eccentric shaft Rear Oil Seal

Check the oil seal for wear or damage. If traces of oil leakage are found, replace the oil seal.

#### 6-B-7. Checking Needle Bearing (Pilot bearing)

Check the pilot bearing for roughness, loose and any damage. If necessary, replace the pilot bearing.

Replace the pilot bearing, proceed as follows.

1. Remove the bearing and seal with the puller (49 1285 071).
2. Install a new pilot bearing with the installer (49 0823 072A) and apply the multipurpose grease on it.
3. Install the oil seal.

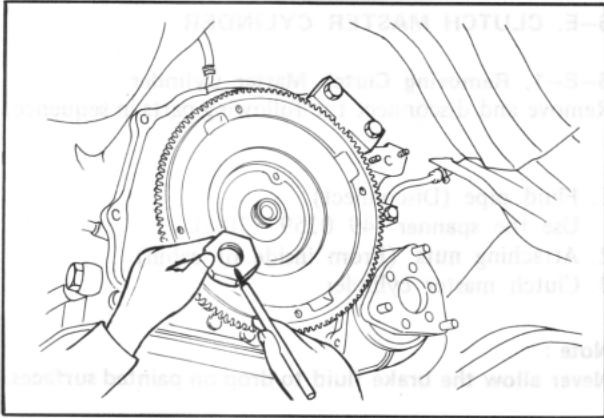

Fig. 6-13

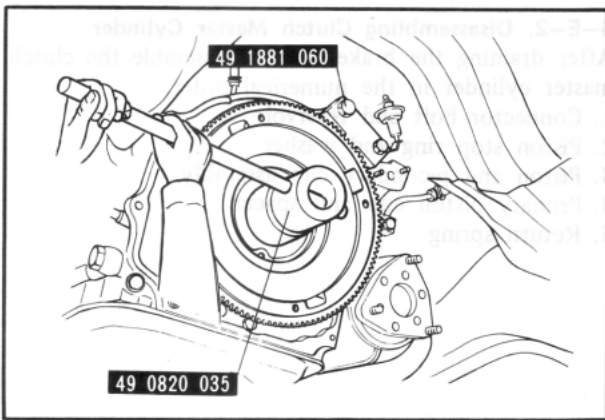

Fig. 6-14

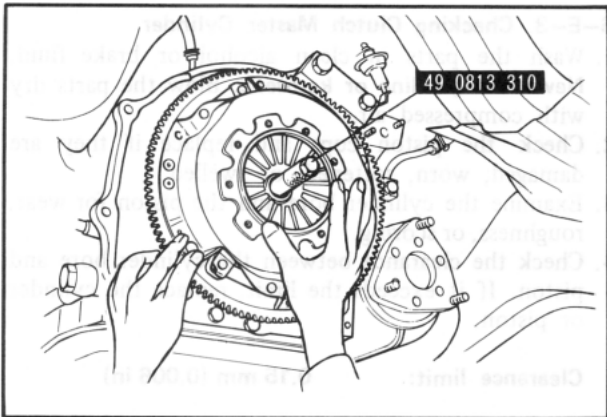

Fig. 6-15

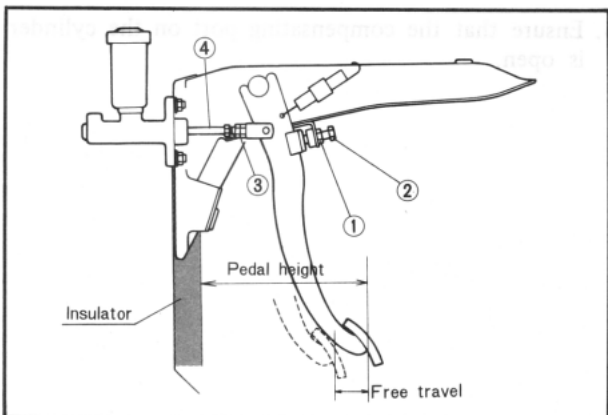

Fig. 6-16

### 6-C. CLUTCH INSTALLATION

Install the clutch in the reverse order of removal, **noting** the followings.

1. Apply the sealing agent to lock nut surface that contact with flywheel and install the lock nut.

2. Attach the **brake** (49 1881 060) and tighten the lock nut to the specifications with the **box wrench** (49 0820 035).

**Flywheel tightening torque:**

**40 ~ 50 m-kg (289 ~ 362 ft-lb)**

3. Hold the clutch disc in its mounting position with the **centering tool** (49 0813 310).  
If the tool is not available, use a spare main drive shaft.

4. Install the pressure plate and cover assembly, **aligning** the "O" mark (small hole) of the clutch cover and reamer bolt hole on the flywheel, and install the 4 standard and 2 reamer bolts finger tight. To avoid pressure plate cover distortion, tighten the bolts a few turns at a time until they are all tight.  
Then torque the bolts to specifications.

**Tightening torque: 1.8 ~ 2.7 m-kg (13 ~ 20 ft-lb)**

### 6-D. CLUTCH PEDAL ADJUSTMENT

1. Adjust the pedal height by loosening the lock nut (1) and turning the stopper bolt (2).

**Pedal height:**  $190 \begin{smallmatrix} +5 \\ -0 \end{smallmatrix}$  mm ( $7.5 \begin{smallmatrix} +0.2 \\ -0 \end{smallmatrix}$  in)

2. Adjust the free travel by loosening the lock nut (3) and turning the push rod (4).

**Free travel:**  $0.6 \sim 3.1$  mm (0.02 ~ 0.12 in)  
at pedal pad

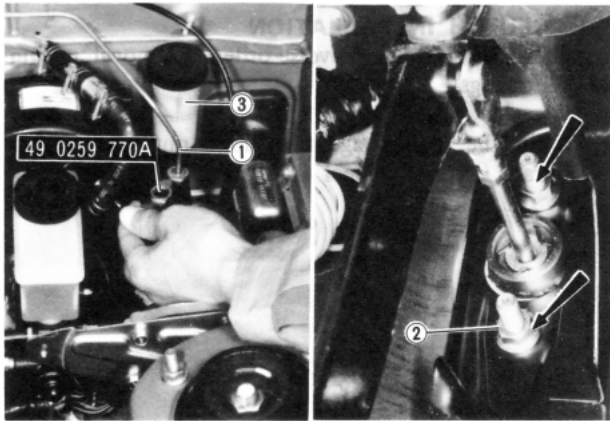

Fig. 6-17

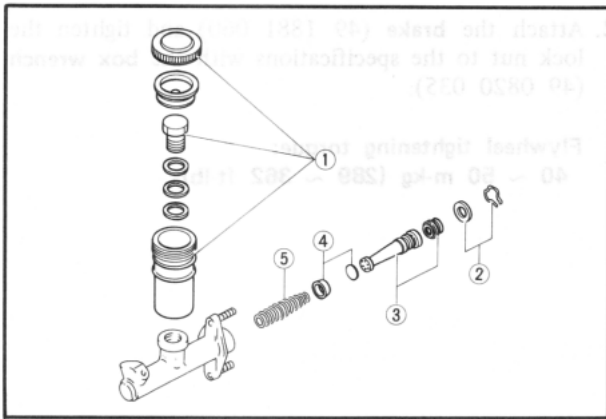

Fig. 6-18



Fig. 6-19

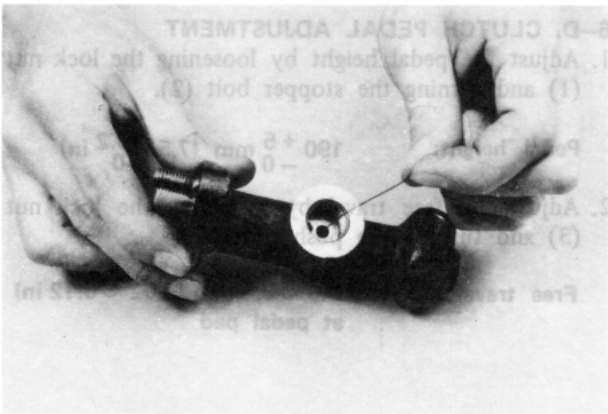

Fig. 6-20

## 6-E. CLUTCH MASTER CYLINDER

### 6-E-1. Removing Clutch Master Cylinder

Remove and disconnect the following parts in sequence.

1. Fluid pipe (Disconnect)  
Use the **spanner** (49 0259 770A).
2. Attaching nuts (From inside of cabin)
3. Clutch master cylinder

#### Note :

**Never allow the brake fluid to drop on painted surfaces.**

### 6-E-2. Disassembling Clutch Master Cylinder

After draining the brake fluid, disassemble the clutch master cylinder in the numerical order.

1. Connector bolt and reservoir
2. Piston stop ring and washer
3. Piston and secondary cup assembly
4. Primary piston cup and spacer
5. Return spring

### 6-E-3. Checking Clutch Master Cylinder

1. Wash the parts in clean alcohol or brake fluid. **Never use gasoline or kerosene.** Blow the parts dry with compressed air.
2. Check the piston cups and replace if they are damaged, worn, softened, or swelled.
3. Examine the cylinder bore and the piston for wear, roughness, or scoring.
4. Check the clearance between the cylinder bore and piston. If it exceeds the limit, replace the cylinder or piston.

**Clearance limit: 0.15 mm (0.006 in)**

5. Ensure that the compensating port on the cylinder is open.



Fig. 6-21

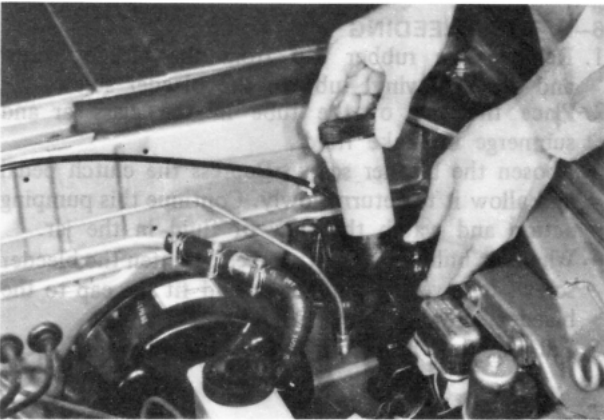

Fig. 6-22

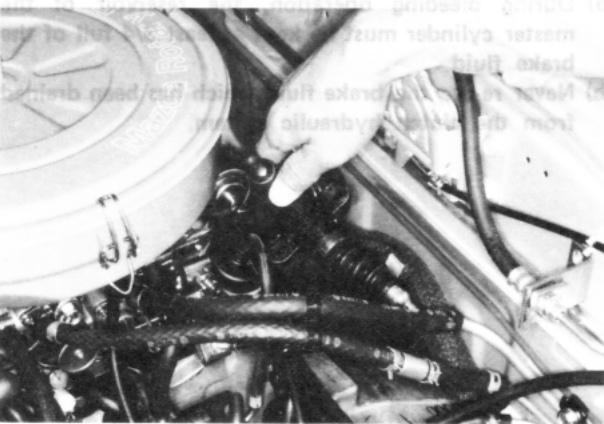

Fig. 6-23

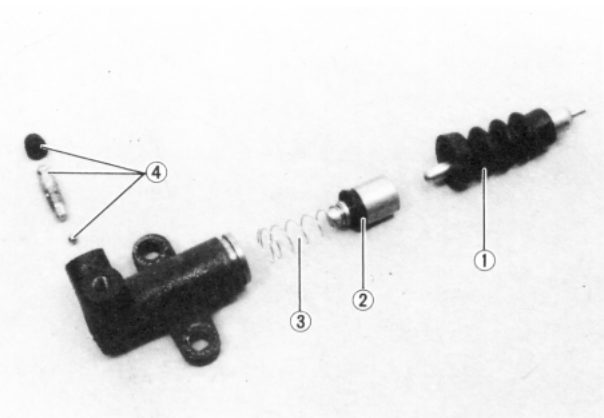

Fig. 6-24

#### 6-E-4. Assembling Clutch Master Cylinder

Assemble the clutch master cylinder in the reverse order of disassembly.

##### Note :

- a) Before assembling, dip the piston and cups in clean brake fluid.
- b) After assembling, fill the cylinder with brake fluid and operate the piston with a screwdriver until the fluid is ejected at the outlet.

#### 6-E-5. Installing Clutch Master Cylinder

To install the clutch master cylinder, carry out the removal operations in the reverse order.

After installing, bleed the clutch hydraulic system, as described in Par. 6-G.

### 6-F. CLUTCH RELEASE CYLINDER

#### 6-F-1. Removing Clutch Release Cylinder

Remove the following parts.

1. Connecting bolt and flexible hose
2. Attaching nuts
3. Release cylinder

#### 6-F-2. Disassembling Clutch Release Cylinder

Disassemble the clutch master cylinder in the numerical order.

1. Dust boot and release rod
2. Piston and cup assembly
3. Spring
4. Bleeder screw and valve (steel ball)

#### 6-F-3. Checking Clutch Release Cylinder

Check the clutch release cylinder in the same manner for the clutch master cylinder.





Fig. 6-25

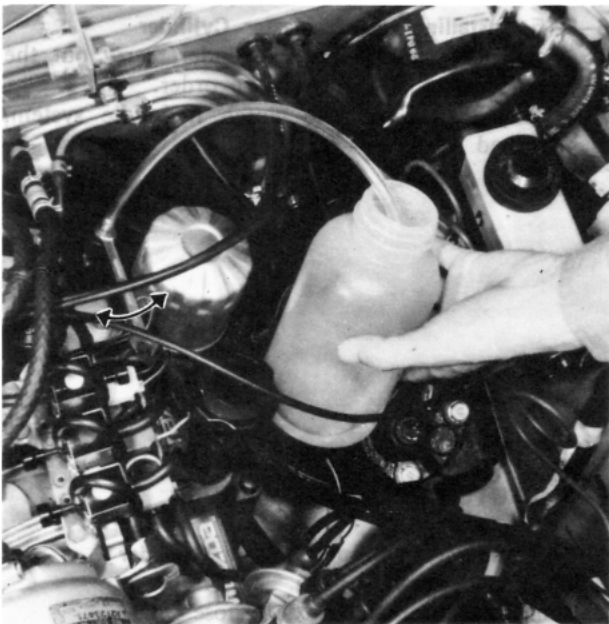

Fig. 6-26

**6-F-4. Assembling Clutch Release Cylinder**

Assemble the clutch release cylinder in the reverse order of disassembly.

**Note :**

Before assembling, dip the piston and cups in the clean brake fluid.

**6-F-5. Installing Clutch Release Cylinder**

Install the clutch release cylinder in the reverse order of removing and bleed the hydraulic system as described in Par. 6-G.

**6-G. AIR BLEEDING**

1. Remove the rubber cap from the bleeder screw and attach a vinyl tube to the bleeder screw.
2. Place the end of the tube in the glass jar and submerge in brake fluid.
3. Loosen the bleeder screw. Depress the clutch pedal and allow it to return slowly. Continue this pumping action and watch the flow of fluid in the jar.
4. When air bubbles cease to appear, tighten the bleeder screw, remove the vinyl tube and fit the cap to the bleeder screw.
5. Fill the fluid reservoir and fit the filler cap.

**Note :**

- a) During bleeding operation, the reservoir of the master cylinder must be kept at least 3/4 full of the brake fluid.
- b) Never re-use the brake fluid which has been drained from the clutch hydraulic system.